

TEST BANK

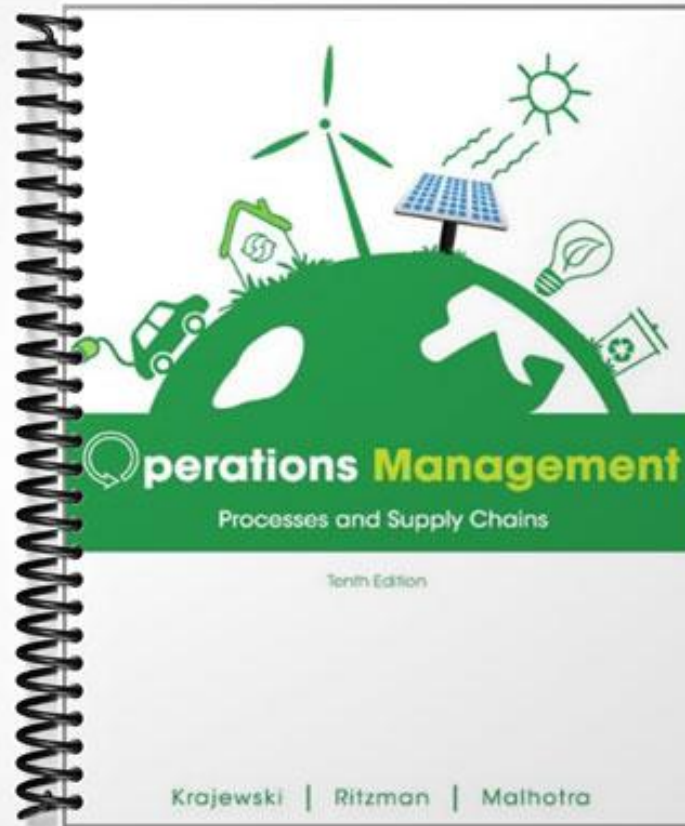

Operations Management

Processes and Supply Chains

Tenth Edition

Krajewski | Ritzman | Malhotra

Operations Management: Processes and Supply Chains, 10e (Krajewski et al.)
Supplement A Decision Making

1) The break-even quantity is the volume at which the total revenue equals total cost.

Answer: TRUE

Reference: Break-Even Analysis

Difficulty: Easy

Keywords: break-even quantity, total revenue, total cost

2) The variable cost is the portion of total cost that remains constant regardless of changes in levels of production.

Answer: FALSE

Reference: Break-Even Analysis

Difficulty: Easy

Keywords: variable cost, level of output, break-even point

3) Fixed cost is the portion of the total cost that remains constant regardless of changes in levels of output.

Answer: TRUE

Reference: Break-Even Analysis

Difficulty: Moderate

Keywords: fixed cost, level of output, break-even quantity

4) Sensitivity analysis is a technique for systematically changing parameters in a model to determine the effects of such changes.

Answer: TRUE

Reference: Break-Even Analysis

Difficulty: Moderate

Keywords: sensitivity analysis, parameter, break-even quantity

5) A preference matrix is a table that allows the manager to rate an alternative according to one performance criterion.

Answer: FALSE

Reference: Preference Matrix

Difficulty: Moderate

Keywords: preference matrix, alternative, performance criteria

6) Decision theory is a general approach to decision making when the outcomes associated with alternatives are often in doubt.

Answer: TRUE

Reference: Decision Theory

Difficulty: Moderate

Keywords: decision theory, uncertainty, risk

7) A payoff table shows the amount for each alternative if each possible event occurs.

Answer: TRUE

Reference: Decision Theory

Difficulty: Moderate

Keywords: payoff table, event

8) If the payoff table contains expenses instead of revenues, then the optimistic criterion is Minimin.

Answer: TRUE

Reference: Decision Theory

Difficulty: Moderate

Keywords: maximax, optimist, pessimist

9) If a new alternative is added to a payoff table and the maximax criterion is applied again, the new decision must either remain with the original maximax alternative or the new alternative.

Answer: TRUE

Reference: Decision Theory

Difficulty: Moderate

Keywords: maximax, alternative

10) If the payoff table contains expenses instead of revenues, then the pessimistic criterion is Minimin.

Answer: FALSE

Reference: Decision Theory

Difficulty: Moderate

Keywords: maximax, optimist, pessimist

11) The Laplace criterion will reach the same decision as the Minimax Regret criterion when the payoff table contains expenses instead of revenues.

Answer: FALSE

Reference: Decision Theory

Difficulty: Moderate

Keywords: minimax regret, Laplace, payoff table

12) Maximax is a decision rule for the pessimist.

Answer: FALSE

Reference: Decision Theory

Difficulty: Moderate

Keywords: maximax, optimist, pessimist

13) By definition, the maximax and maximin criteria cannot result in the selection of a common alternative in decision making under uncertainty.

Answer: FALSE

Reference: Decision Theory

Difficulty: Moderate

Keywords: decision making, maximax, maximin

14) Making a decision under risk using the expected value criterion is the equivalent of using the Laplace decision rule under uncertainty.

Answer: TRUE

Reference: Decision Theory

Difficulty: Moderate

Keywords: Laplace decision rule, expected value

15) The square nodes in a decision tree represent the alternatives in a sequential decision situation.

Answer: FALSE

Reference: Decision Theory

Difficulty: Moderate

Keywords: node, decision tree, sequential decisions

16) Which one of the following statements about break-even analysis for evaluating products or services is true?

A) The break-even quantity will tend to increase as the variable cost per unit of production decreases.

B) As sales increase beyond the break-even quantity, total before-tax profits tend to decrease.

C) A restaurant's opening of downsized facilities with only drive-through service is an example of lowering fixed costs and the break-even quantity.

D) Increasing the unit selling price has the effect of increasing the break-even quantity.

Answer: C

Reference: Break-Even Analysis

Difficulty: Moderate

Keywords: break-even, fixed cost

17) Which one of the following statements about break-even analysis, as we applied it to evaluating products or services, is best?

A) Break-even analysis assumes that the cost function is linear and consists of fixed costs plus variable costs times volume.

B) The break-even quantity will increase when the change in variable cost per unit is identical to the change in unit price.

C) Increasing the price, while keeping the variable cost per unit constant, increases the break-even quantity.

D) Increasing the fixed costs tends to decrease the break-even quantity.

Answer: A

Reference: Break-Even Analysis

Difficulty: Moderate

Keywords: break-even quantity, fixed cost, variable cost

18) Which condition would result in invalidating an application of break-even analysis?

A) The variable cost to produce a unit is less than one percent of the fixed cost to run the plant.

B) The purchasing department both offers quantity discounts to customers and receives quantity discounts from suppliers.

C) The variable cost to produce a unit is within one percent of the sale price.

D) The labor to manufacture the item is free.

Answer: B

Reference: Break-Even Analysis

Difficulty: Moderate

Keywords: break-even quantity, volume, cost

19) Mantel Incorporated began producing its new line of dolls at its Connecticut plant in December of year 0. In year 1, it produced 30,000 dolls at a total cost of \$385,000. In year 2, its production increased to 80,000 dolls at a total cost of \$885,000. Assuming the cost structure was the same for both years, what must be the variable cost (c) and the fixed cost (F) per doll?

- A) F is less than \$80,000, and c is greater than \$7.
- B) F is greater than \$60,000, and c is less than \$5.
- C) F is less than \$100,000, and c is greater than \$9.
- D) F is greater than \$110,000, and c is less than \$6.

Answer: C

Reference: Break-Even Analysis

Difficulty: Moderate

Keywords: break-even quantity, variable cost, fixed cost

AACSB: Analytic skills

20) The break-even quantity for a certain kitchen appliance is 6000 units. The selling price is \$10 per unit, and the variable cost is \$4 per unit. What must be the fixed cost to break even at 6000 units?

- A) less than \$35,000
- B) between \$35,000 and \$40,000
- C) between \$40,001 and \$45,000
- D) above \$45,000

Answer: B

Reference: Break-Even Analysis

Difficulty: Moderate

Keywords: break-even quantity, fixed cost

AACSB: Analytic skills

21) A "Little Sis" restaurant has been opened as a prototype to test the concept of a smaller facility with a limited menu. Experience during the first two years was as follows:

Year	Annual Volume (customer visits)	Total Cost (\$) (fixed plus variable cost)
Year 1	40,000	600,000
Year 2	60,000	700,000

The average sale is \$10 per customer. Use the following partially completed graph to determine the break-even quantity graphically. Then refine your solution by solving it algebraically. (Show your work for credit.)

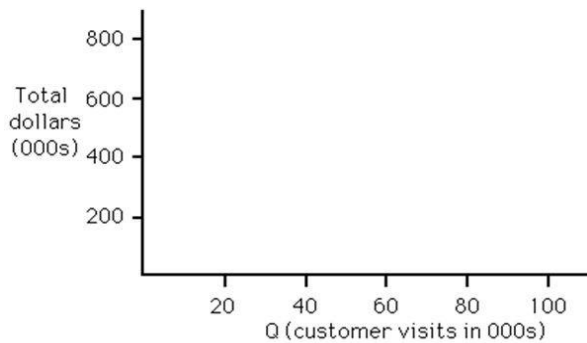

- A) The break-even quantity is fewer than or equal to 30,000 customer visits.
- B) The break-even quantity is more than 30,000 customer visits and fewer than or equal to 50,000 visits.
- C) The break-even quantity is more than 50,000 visits and fewer than or equal to 70,000 visits.
- D) The break-even quantity is more than 70,000 customer visits.

Answer: D

Reference: Break-Even Analysis

Difficulty: Hard

Keywords: break-even quantity

AACSB: Analytic skills

22) Minor Video has opened a new store renting videocassettes. Fixed costs are \$60,000, and the variable cost per unit is \$1.50. The average sale is \$5 per customer. Use the following axes to determine the break-even quantity graphically. Next, refine your solution by solving it algebraically. (Show your work for credit.)

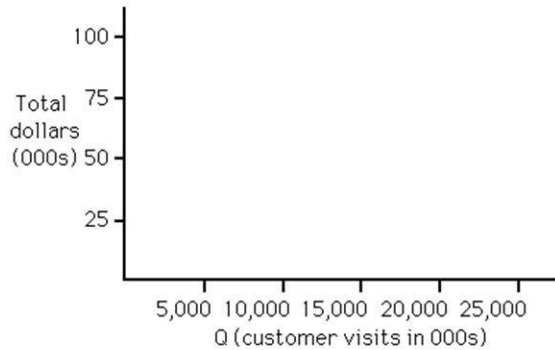

- A) The break-even quantity is fewer than or equal to 10,000 rentals.
- B) The break-even quantity is more than 10,000 rentals and fewer than or equal to 20,000 rentals.
- C) The break-even quantity is more than 20,000 rentals and fewer than or equal to 25,000 rentals.
- D) The break-even quantity is more than 25,000 rentals.

Answer: B

Reference: Break-Even Analysis

Difficulty: Moderate

Keywords: break-even quantity

AACSB: Analytic skills

23) A new product is being considered that will require \$45,000 in fixed costs per year. Variable costs per unit are estimated to be \$12.72. The firm wants to break even if 8000 units are produced and sold per year. What should be the price?

- A) less than \$16.00
- B) between \$16.00 and \$16.99
- C) between \$17.00 and \$17.99
- D) between \$18.00 and \$18.99

Answer: D

Reference: Break-Even Analysis

Difficulty: Moderate

Keywords: break-even quantity, price per unit

AACSB: Analytic skills

24) A software company that sells its software pre-installed in personal computers is considering making its own computers instead of purchasing them from the Mega-Chip Company. To assemble their own computers could cost \$1,000,000 in fixed costs and \$100 per unit in variable costs. The company currently buys PCs for \$1200, with no fixed costs. What is the break-even quantity?

- A) greater than or equal to 1800
- B) greater than 900 but fewer than 1800
- C) greater than 450 but fewer than 900
- D) less than 450

Answer: B

Reference: Break-Even Analysis

Difficulty: Hard

Keywords: break-even quantity

AACSB: Analytic skills

25) A new product will sell in the market for \$12. It costs \$7 (unit variable cost) to manufacture on a new lathe machine. If the break-even quantity is 10,000 units, what is the annual fixed cost involved in acquiring the machine and in paying other fixed costs?

- A) less than \$40,000
- B) greater than \$40,000 but less than or equal to \$55,000
- C) greater than \$55,000 but less than or equal to \$70,000
- D) greater than \$70,000

Answer: B

Reference: Break-Even Analysis

Difficulty: Moderate

Keywords: break-even quantity, fixed cost

AACSB: Analytic skills

26) A new product that will sell for \$75.00 has variable costs of \$38.00 per unit. Fixed costs of \$75,000 must be incurred every year to manufacture this product. What is the annual volume to break even?

- A) fewer than 1500 units.
- B) 1500 to 1749 units.
- C) 1750 to 1999 units.
- D) 2000 units or more.

Answer: D

Reference: Break-Even Analysis

Difficulty: Moderate

Keywords: break-even quantity

AACSB: Analytic skills

27) Commodore is debating whether to produce the printed circuit boards for a new line of video cameras or outsource their production to a company that specializes in this operation. Strictly from a cost standpoint, production of the circuit boards would definitely be outsourced if:

- A) the variable cost of producing the circuit boards is lower than the buy option.
- B) the production volumes are greater than Commodore's break-even quantity.
- C) the production volumes are less than Commodore's break-even quantity.
- D) the production volumes are the same for making and buying the circuit boards.

Answer: C

Reference: Break-Even Analysis

Difficulty: Easy

Keywords: break-even quantity

28) A poultry farmer is debating whether to acquire Rhode Island Reds or Buff Orpingtons to lay the eggs he wants to sell. The fixed costs for the Buffs would be \$7500 and the variable costs per egg would be a dime per egg. The Reds would have a fixed cost of \$6000 and a variable cost of fifteen cents. At what level of egg production would the poultry farmer be indifferent between Rhode Island Reds and Buff Orpingtons?

- A) 20,000 eggs
- B) 30,000 eggs
- C) 50,000 eggs
- D) 60,000 eggs

Answer: B

Reference: Break-Even Analysis

Difficulty: Moderate

Keywords: break-even quantity

AACSB: Analytic skills

29) Zipco is in serious negotiations to purchase a chunking machine that will enable them to perform their own chunking at \$1 per unit. They currently have their chunking outsourced at a cost of \$1.50 per unit and a fixed cost of \$45,000. Their marketing team feels that they can sustain an annual volume of 10,000 units. What is the maximum fixed cost that Zipco should be willing to bear in order to perform their own chunking?

- A) \$50,000
- B) \$45,000
- C) \$40,000
- D) \$35,000

Answer: A

Reference: Break-Even Analysis

Difficulty: Moderate

Keywords: break-even quantity, fixed cost

AACSB: Analytic skills

30) Demron is in serious negotiations to purchase a welding machine that will enable them to perform their own welding. They currently have their welding outsourced at a cost of \$1.50 per weld and a fixed cost of \$45,000. Their marketing team feels that they can sustain an annual sales volume sufficient to require 35,000 welds. If a fancy new welding rig costs \$13,500 what is the maximum variable cost per weld that Demron should be willing to pay in order to bring this process in-house?

- A) \$3.00 per weld
- B) \$2.40 per weld
- C) \$2.00 per weld
- D) \$1.45 per weld

Answer: B

Reference: Break-Even Analysis

Difficulty: Moderate

Keywords: break-even quantity, variable cost, make-or-buy quantity

AACSB: Analytic skills

Table A.1

Use the following to answer the questions below.

Luvmatics plans to produce a new product. Three different models are planned: the Regular, Large, and Jumbo. The fixed costs depend on which of two locations are used; in San Francisco the fixed costs would be \$2.5 million per year, but in Tuttle the fixed costs would be \$1.2 million. Sale prices and variable costs for the three models are shown in the table.

	Model		
	Regular	Large	Jumbo
Variable Cost	\$5/unit	\$7/unit	\$10/unit
Sale Price	\$25/unit	\$41/unit	\$68/unit

31) Use the information in Table A.1. How many units of the Regular size must be sold each year to break even if production is at the San Francisco plant?

- A) fewer than 30,000 units
- B) more than 30,000 units but fewer than 80,000 units
- C) more than 80,000 units but fewer than 130,000 units
- D) more than 130,000 units

Answer: C

Reference: Break-Even Analysis

Difficulty: Moderate

Keywords: break-even quantity

AACSB: Analytic skills

32) Use the information in Table A.1. If executives decide to produce at the San Francisco plant but are nervous about sales numbers, which model would provide the greatest profit at the lowest sales volumes?

- A) regular
- B) large
- C) jumbo
- D) It doesn't matter because the fixed costs are the same for the same site.

Answer: C

Reference: Break-Even Analysis

Difficulty: Moderate

Keywords: break-even quantity

AACSB: Analytic skills

33) Use the information in Table A.1. What is the difference in break-even points for the Large model between Tuttle and San Francisco?

- A) fewer than 25,000 units
- B) between 25,000 units and 40,000 units
- C) between 40,000 units and 55,000 units
- D) more than 55,000 units

Answer: B

Reference: Break-Even Analysis

Difficulty: Moderate

Keywords: break-even quantity

AACSB: Analytic skills

34) Use the information in Table A.1. How much does Luvmatics make for each Jumbo unit that is produced in Tuttle and sold at the listed price?

- A) \$68
- B) \$58
- C) \$34
- D) This cannot be determined without any information on the production volume.

Answer: B

Reference: Break-Even Analysis

Difficulty: Easy

Keywords: break-even quantity, slope

AACSB: Analytic skills

35) Use the information in Table A.1. What is the slope of the fixed-cost line for production in San Francisco?

- A) \$2,500,000
- B) \$25
- C) \$20
- D) 0

Answer: D

Reference: Break-Even Analysis

Difficulty: Easy

Keywords: break-even quantity, slope

AACSB: Analytic skills

36) Use the information in Table A.1. Assume the fixed costs and sales price in both locations are constants and the variable costs in San Francisco are as shown in the table. By how much would the variable cost in Tuttle have to rise to give both locations an identical break-even point for the Regular model?

- A) \$0.40
- B) \$5.40
- C) \$10.40
- D) \$15.40

Answer: C

Reference: Break-Even Analysis

Difficulty: Moderate

Keywords: break-even quantity, variable cost

AACSB: Analytic skills

Use the following to answer the questions below.

A company must decide if it will make or buy an item it needs. The company can make the item for \$10 per unit, but must invest \$15,000 in tooling to do so. An outside firm has quoted a total price of \$12 per unit to supply the quantity required (assume their fixed costs are included in the quoted price).

37) Refer to the instruction above. What is the break-even quantity in this situation?

- A) 6,500 units
- B) 7,000 units
- C) 7,250 units
- D) 7,500 units

Answer: D

Reference: Break-Even Analysis

Difficulty: Moderate

Keywords: break-even quantity, make-or-buy, fixed cost, variable cost

AACSB: Analytic skills

38) Refer to the instruction above. Which alternative should be selected if annual requirements are 5,000 units?

- A) Make
- B) Buy
- C) Either Make or Buy; costs are the same for either option at 5,000 units
- D) Can't be determined with information given

Answer: B

Reference: Break-Even Analysis

Difficulty: Moderate

Keywords: break-even quantity, break-even volume, make-or-buy, fixed cost, variable cost

AACSB: Analytic skills

39) Refer to the instruction above. What does the company save for the year by selecting this low-cost option (for annual requirements of 5,000 units)?

- A) \$15,000
- B) \$60,000
- C) \$65,000
- D) \$5,000

Answer: D

Reference: Break-Even Analysis

Difficulty: Moderate

Keywords: break-even quantity, make-or-buy, fixed cost, variable cost

AACSB: Analytic skills

Use the following to answer the questions below.

A company is considering two suppliers for the purchase of a part needed for manufacturing. Particulars are as follows:

SUPPLIER A:	Fixed Costs = \$9,000 / year	Variable Cost / Unit = \$2
SUPPLIER B:	Fixed Costs = \$3,000 / year	Variable Cost / Unit = \$5

40) Refer to the instruction above. What is the annual break-even quantity for choosing between the two suppliers?

- A) 1,000 units
- B) 2,000 units
- C) 6,000 units
- D) 12,000 units

Answer: B

Reference: Break-Even Analysis

Difficulty: Moderate

Keywords: break-even quantity, make-or-buy, fixed cost, variable cost

AACSB: Analytic skills

41) Refer to the instruction above. For an annual volume of 3,000 units, which supplier should be chosen?

- A) Supplier A
- B) Supplier B
- C) Either Supplier A or Supplier B, because costs are the same for either option at 3,000 units
- D) Can't be determined with information given

Answer: A

Reference: Break-Even Analysis

Difficulty: Moderate

Keywords: break-even point, break-even volume, make-or-buy, fixed cost, variable cost

AACSB: Analytic skills

42) Refer to the instruction above. What does the company save for the year by selecting this low-cost option (for annual requirements of 3,000 units)?

- A) \$1,000
- B) \$3,000
- C) \$6,000
- D) \$5,000

Answer: B

Reference: Break-Even Analysis

Difficulty: Moderate

Keywords: break-even point, make-or-buy, fixed cost, variable cost

AACSB: Analytic skills

Use the following information to answer the questions below.

You currently make a part for old equipment at a cost of \$20 / unit. The annual fixed cost for this equipment is \$50,000. You have found an outside supplier who will make the part for \$15 / unit if you will pay their annual fixed costs of \$200,000 / year (see table).

<u>ALTERNATIVE</u>	<u>FIXED COST</u>	<u>VARIABLE COST</u>
Buy	\$200,000 per year	\$15 per unit
Make	\$50,000 per year	\$20 per unit

43) Refer to the instruction above. What is the break even quantity between buying and making?

- A) 30,000 units per year
- B) 40,000 units per year
- C) 50,000 units per year
- D) 60,000 units per year

Answer: A

Reference: Break-Even Analysis

Difficulty: Moderate

Keywords: break-even quantity, make-or-buy, fixed cost, variable cost

AACSB: Analytic skills

44) Refers to the instruction above. What are total costs to buy an annual quantity of 40,000 units?

- A) \$400,000
- B) \$500,000
- C) \$800,000
- D) \$850,000

Answer: C

Reference: Break-Even Analysis

Difficulty: Moderate

Keywords: break-even quantity, break-even volume, make-or-buy, fixed cost, variable cost

AACSB: Analytic skills

45) Refer to the instruction above. What are total costs to make a quantity of 40,000 units per year?

- A) \$400,000
- B) \$450,000
- C) \$800,000
- D) \$850,000

Answer: D

Reference: Break-Even Analysis

Difficulty: Moderate

Keywords: break-even quantity, make-or-buy, total cost, fixed cost, variable cost

AACSB: Analytic skills

46) Refer to the instruction above. For what range of output would you prefer to buy?

- A) 0 - 30,000 units per year
- B) 30,000 or more units per year
- C) 40,000 or more units per year
- D) 0 - 40,000 units per year

Answer: B

Reference: Break-Even Analysis

Difficulty: Moderate

Keywords: break-even quantity, range of output, make-or-buy, fixed cost, variable cost

AACSB: Analytic skills

47) Refer to the instruction above. For what range of output would you prefer to make?

- A) 30,000 or more units per year
- B) 0 - 30,000 units per year
- C) 0 - 40,000 units per year
- D) 40,000 or more units per year

Answer: B

Reference: Break-Even Analysis

Difficulty: Moderate

Keywords: break-even quantity, range of output, make-or-buy, fixed cost, variable cost

AACSB: Analytic skills

48) Refer to the instruction above. What does the company save for the year by selecting the low-cost option (for annual requirements of 40,000 units)?

- A) \$150,000
- B) \$300,000
- C) \$50,000
- D) \$40,000

Answer: C

Reference: Break-Even Analysis

Difficulty: Moderate

Keywords: break-even quantity, make-or-buy, total cost, fixed cost, variable cost

AACSB: Analytic skills

Use the following to answer the questions below.

A proposal for implementing a new product line has an annual fixed cost of \$60,000, variable cost of \$35 per unit of output, and revenue (selling price) of \$55 per unit of output.

49) Refer to the instruction above. What is the break-even quantity?

- A) 2,000 units per year
- B) 3,000 units per year
- C) 6,000 units per year
- D) 20,000 units per year

Answer: B

Reference: Break-Even Analysis

Difficulty: Moderate

Keywords: break-even quantity, total cost, fixed cost, variable cost, selling price per unit

AACSB: Analytic skills

50) Refer to the instruction above. What volume of output will be necessary for an annual profit of \$60,000?

- A) 2,000 units
- B) 3,000 units
- C) 6,000 units
- D) 20,000 units

Answer: C

Reference: Break-Even Analysis

Difficulty: Moderate

Keywords: break-even quantity, volume of output, total cost, fixed cost, variable cost, profit

AACSB: Analytic skills

51) Refer to the instruction above. What selling price would be necessary to generate an annual profit of \$90,000, if expected volume is 6,000 units per year (assume fixed costs remain at \$60,000, and variable cost per unit at \$35)?

- A) \$30 / unit
- B) \$40 / unit
- C) \$50 / unit
- D) \$60 / unit

Answer: D

Reference: Break-Even Analysis

Difficulty: Moderate

Keywords: break-even quantity, total cost, fixed cost, variable cost, selling price per unit

AACSB: Analytic skills

52) A company is screening ideas for new services. Five alternative service ideas are being considered. Management identified four criteria and weighted them as follows: A = 30, B = 10, C = 20, and D = 40. They have also come up with scored values for the five alternatives and the four criteria as shown following. Management has decided that if an alternative has less than a total scored value of 600, it should automatically be rejected. Use the preference matrix technique to determine which idea should be accepted.

	Alternatives				
Criterion	1	2	3	4	5
A	8	5	3	7	5
B	7	3	6	6	4
C	2	4	5	3	3
D	4	5	2	3	8

- A) service #1 or #2
- B) service #3 or #4
- C) service #5
- D) none

Answer: D

Reference: Preference Matrix

Difficulty: Moderate

Keywords: preference matrix

AACSB: Analytic skills

53) The Forsite Company is screening three new product ideas. Resource constraints allow only one idea to be commercialized at the present time. The following estimates have been made for the five performance criteria that management feels are most important. If the five criteria are equally weighted, what are the best and worst alternatives?

Performance Criterion	Estimated Rating		
	Product		
	A	B	C
1. Demand uncertainty and project risk	0.3	0.9	0.2
2. Similarity to present products	0.7	0.8	0.6
3. Expected return on investment	1.0	0.4	0.8
4. Compatitbility with current manufacturing process	0.4	0.7	0.6
5. Competitive advantage	0.4	0.6	0.5

- A) A is best, and B is worst.
- B) B is best, and C is worst.
- C) B is best, and A is worst.
- D) C is best, and A is worst.

Answer: B

Reference: Preference Matrix

Difficulty: Moderate

Keywords: preference matrix

AACSB: Analytic skills

54) California Manufacturing, Inc. is now evaluating two new product ideas, and management has decided to apply the preference matrix method. The following table shows five criteria with different weights and individual scores of each product idea. If management has established a threshold of 800, which product(s) should be accepted for further development?

		Score	
		Product	
Performance Criterion	Weight	A	B
Market potential	40	10	8
Profitability	30	8	8
Operations compatibility	15	2	10
Investment requirements	10	4	6
Risk	5	6	8
	<u>100</u>		

- A) product A
- B) product B
- C) Both products A and B
- D) Neither product A nor B

Answer: B
 Reference: Preference Matrix
 Difficulty: Moderate
 Keywords: preference matrix
 AACSB: Analytic skills

55) Choosing the alternative that is the "best of the worst" using decision making under uncertainty would be:

- A) maximin.
- B) maximax.
- C) Laplace.
- D) minimax regret.

Answer: A
 Reference: Decision Theory
 Difficulty: Moderate
 Keywords: maximin decision

56) Choosing the alternative that is the best weighted payoff using decision making under uncertainty would be:

- A) maximin.
- B) maximax.
- C) Laplace.
- D) minimax regret.

Answer: C
 Reference: Decision Theory
 Difficulty: Moderate
 Keywords: Laplace, weighted payoff

57) Choosing the alternative that minimizes lost-opportunity costs using decision making under uncertainty would be:

- A) maximin.
- B) maximax.
- C) Laplace.
- D) minimax regret.

Answer: D

Reference: Decision Theory

Difficulty: Moderate

Keywords: opportunity cost, minimax regret

58) The decision rule in decision making under uncertainty that would be best for the manager who has high expectations would be:

- A) maximin.
- B) maximax.
- C) Laplace.
- D) minimax regret.

Answer: B

Reference: Decision Theory

Difficulty: Moderate

Keywords: maximax

59) The decision rule in decision making under uncertainty most appropriate for the pessimistic manager would be:

- A) maximin.
- B) maximax.
- C) Laplace.
- D) minimax regret.

Answer: A

Reference: Decision Theory

Difficulty: Moderate

Keywords: pessimist, maximin

60) The decision rule most appropriate for the realistic manager using decision making under uncertainty would be:

- A) maximin.
- B) maximax.
- C) Laplace.
- D) minimax regret.

Answer: C

Reference: Decision Theory

Difficulty: Moderate

Keywords: realist, Laplace

Table A.2

Use the following to answer the questions below.

A company that is introducing a new product has to choose between three different manufacturing methods, referred to as methods A, B, and C. Depending on the demand for the product, they have forecast different levels of revenue for the year (values are in thousands). The company has identified three possible states of nature for economic growth, and named them High, Medium, and Low.

	High	Medium	Low
Method A	\$80	\$61	\$38
Method B	\$22	\$46	\$100
Method C	\$9	\$14	\$52
Method D	\$44	\$55	\$24

61) Using the information in Table A.2, which alternative is best in accordance with a decision criterion of maximin?

- A) A
- B) B
- C) C
- D) D

Answer: A

Reference: Decision Theory

Difficulty: Moderate

Keywords: maximin, decision theory

AACSB: Analytic skills

62) Using the information in Table A.2, which alternative is best in accordance with a decision criterion of maximax?

- A) A
- B) B
- C) C
- D) D

Answer: B

Reference: Decision Theory

Difficulty: Moderate

Keywords: maximax, decision theory

AACSB: Analytic skills

63) Using the information in Table A.2, which alternative is best in accordance with a decision criterion of Laplace?

- A) A
- B) B
- C) C
- D) D

Answer: A

Reference: Decision Theory

Difficulty: Moderate

Keywords: Laplace, decision theory

AACSB: Analytic skills

64) Using the information in Table A.2, which alternative is best in accordance with a decision criterion of minimax regret?

- A) A
- B) B
- C) C
- D) D

Answer: B

Reference: Decision Theory

Difficulty: Moderate

Keywords: minimax regret

AACSB: Analytic skills

65) Using the information in Table A.2, which alternative is best if further study revealed that the probability of high growth is 0.2, the probability of medium growth is 0.5, and the probability of low growth is 0.3?

- A) A
- B) B
- C) C
- D) D

Answer: A

Reference: Decision Theory

Difficulty: Moderate

Keywords: decision theory, risk

AACSB: Analytic skills

Table A.3

Use the following to answer the questions below.

A company that is introducing a new product has to choose between four different manufacturing methods, referred to as methods A, B, C and D. Depending on the demand for the product, they have forecast different levels of expenses for the year (values are in thousands). The company has identified three possible states of nature for economic growth, and named them High, Medium, and Low.

	High	Medium	Low
Method A	\$450	\$670	\$780
Method B	\$950	\$320	\$200
Method C	\$375	\$575	\$775
Method D	\$800	\$400	\$300

66) Using the information in Table A.3, which alternative is best in accordance with an optimistic outlook?

- A) A
- B) B
- C) C
- D) D

Answer: B

Reference: Decision Theory

Difficulty: Moderate

Keywords: maximax, decision theory

AACSB: Analytic skills

67) Using the information in Table A.3, which alternative is best in accordance with a pessimistic outlook?

- A) A
- B) B
- C) C
- D) D

Answer: C

Reference: Decision Theory

Difficulty: Moderate

Keywords: maximin, decision theory

AACSB: Analytic skills

68) Using the information in Table A.3, which alternative is best in accordance with a decision criterion of Laplace?

- A) A
- B) B
- C) C
- D) D

Answer: B

Reference: Decision Theory

Difficulty: Moderate

Keywords: Laplace, decision theory

AACSB: Analytic skills

69) Using the information in Table A.3, which alternative is best in accordance with a decision criterion of minimax regret?

- A) A
- B) B
- C) C
- D) D

Answer: D

Reference: Decision Theory

Difficulty: Moderate

Keywords: minimax regret

AACSB: Analytic skills

70) Using the information in Table A.3, which alternative is best if further study revealed that the probability of high growth is 0.2, the probability of medium growth is 0.5, and the probability of low growth is 0.3?

- A) A
- B) B
- C) C
- D) D

Answer: B

Reference: Decision Theory

Difficulty: Moderate

Keywords: decision theory, risk

AACSB: Analytic skills

Table A.4

Use the following to answer the questions below.

In choosing between three new jobs, Joe MBA considers the potential payoffs over the next three years. The following table contains the payoffs, given the speed of promotion in each of the organizations. The probability of fast promotion is 0.6, and the probability of slow promotion is 0.4.

Alternative	Slow Promotion	Fast Promotion
A. High-flying consultant	(\$180,000)	\$600,000
B. Utility analyst	\$200,000	\$400,000
C. Research assistant	\$250,000	\$260,000

71) Use the information in Table A.4. Which alternative is best, given the matrix payoff?

- A) The A alternative would be chosen using the maximin decision rule.
- B) The B alternative would be chosen using the maximax decision rule.
- C) The C alternative would be chosen using the Laplace decision rule.
- D) The C alternative would be chosen using the maximin decision rule.

Answer: D

Reference: Decision Theory

Difficulty: Moderate

Keywords: maximin, payoff

AACSB: Analytic skills

72) Use the information in Table A.4 and the Laplace decision rule. The weighted payoff is:

- A) less than \$200,000 if the high-flying consultant job is selected.
- B) more than \$280,000 if the research assistant job is selected.
- C) more than \$280,000 if the utility analyst job is selected.
- D) highest for the research assistant position.

Answer: C

Reference: Decision Theory

Difficulty: Moderate

AACSB: Analytic skills

73) Use the information in Table A.4 and the minimax regret decision rule. The maximum regret is:

- A) less than \$300,000 if the high-flying consultant job is selected.
- B) less than \$300,000 if the utility analyst job is selected.
- C) less than \$300,000 if the research assistant job is selected.
- D) lowest for the research assistant job.

Answer: B

Reference: Decision Theory

Difficulty: Moderate

Keywords: minimax regret

AACSB: Analytic skills

74) Use the information in Table A.4 and the expected-value rule. Which statement is TRUE?

- A) The expected value of the consultant job is more than \$300,000.
- B) The expected value of the utility analyst job is more than \$300,000.
- C) The expected value of the research assistant job is less than \$250,000.
- D) The job with the highest expected value is the research assistant.

Answer: B

Reference: Decision Theory

Difficulty: Moderate

Keywords: expected value

AACSB: Analytic skills

75) When using decision tree analysis:

- A) the sum of the expected payoffs must always equal zero.
- B) round nodes represent decision points.
- C) there must be more square nodes than round nodes.
- D) probabilities for all branches leaving a chance node must sum to 1.0.

Answer: D

Reference: Decision Trees

Difficulty: Moderate

Keywords: decision tree, probability, nodes

AACSB: Analytic skills

76) In order for a decision tree to be a valuable decision tool, the decision-maker should be in a condition of:

- A) certainty.
- B) risk.
- C) uncertainty.
- D) equilibrium.

Answer: B

Reference: Decision Theory

Difficulty: Moderate

Keywords: decision tree, risk

AACSB: Analytic skills

77) An operations manager has developed this decision tree to evaluate the alternatives for a planned expansion. If the probability of high demand is 0.6, what is the best course of action?

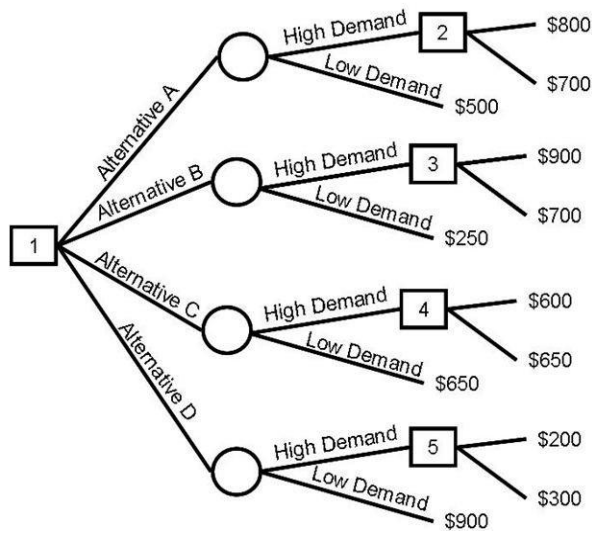

- A) Alternative A
- B) Alternative B
- C) Alternative C
- D) Alternative D

Answer: A

Reference: Decision Trees

Difficulty: Moderate

Keywords: decision tree, risk

AACSB: Analytic skills

78) A marketing director must decide among four alternatives for a new marketing campaign. She ascertains that the probability of high demand is 0.8 and the probability of low demand is 0.2. What is the best choice with the payoffs shown in the tree?

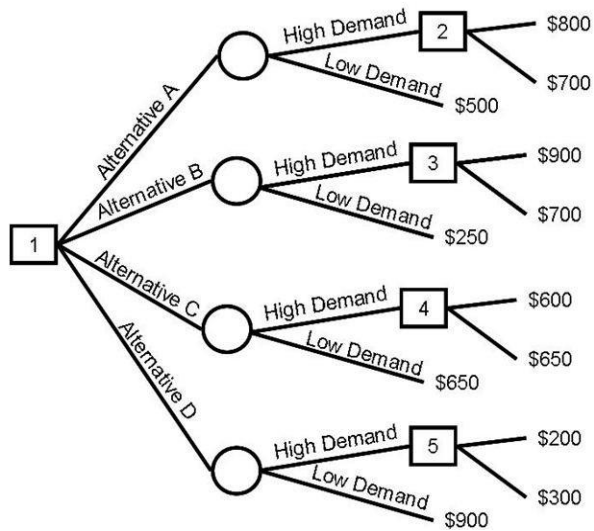

- A) Alternative A
- B) Alternative B
- C) Alternative C
- D) Alternative D

Answer: B

Reference: Decision Trees

Difficulty: Moderate

Keywords: decision tree, risk

AACSB: Analytic skills

79) A marketing director must decide among four alternatives for a new marketing campaign. She ascertains that the probability of high demand is 0.45 and the probability of low demand is 0.55. What is the best choice with the payoffs shown in the tree?

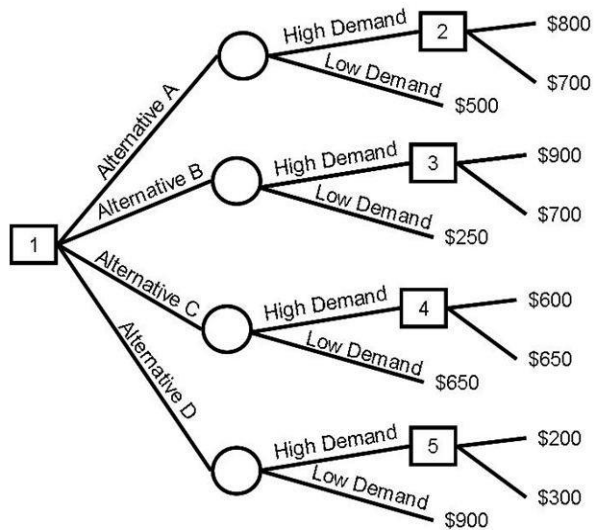

- A) Alternative A
- B) Alternative B
- C) Alternative C
- D) Alternative D

Answer: C

Reference: Decision Trees

Difficulty: Moderate

Keywords: decision tree, risk

AACSB: Analytic skills

80) George Burdell must decide among four alternatives for an oil exploration project. He estimates that the probability of high demand is 0.3 and the probability of low demand is 0.7. What is the best choice with the payoffs shown in the tree?

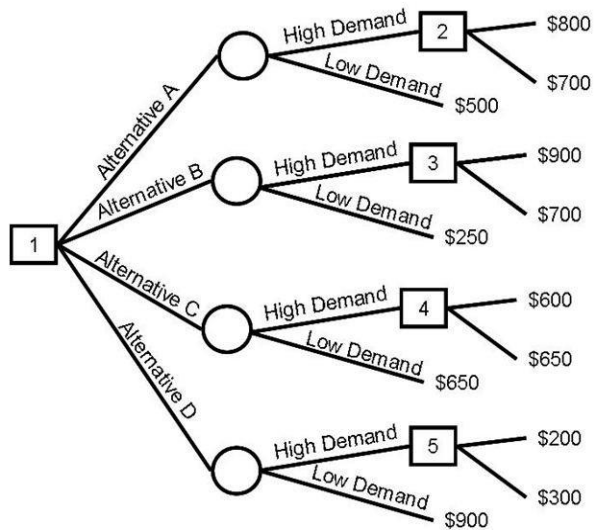

- A) Alternative A
- B) Alternative B
- C) Alternative C
- D) Alternative D

Answer: D

Reference: Decision Trees

Difficulty: Moderate

Keywords: decision tree, risk

AACSB: Analytic skills

81) Analyze the following decision tree. Determine the missing probabilities, and identify the alternative that maximizes the expected payoff.

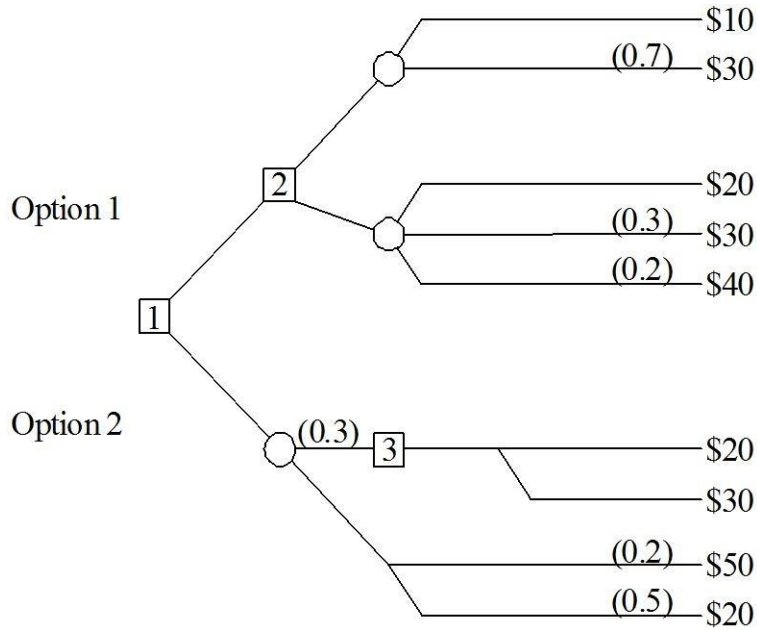

- A) Option 1, with an expected payoff of less than \$25
- B) Option 1, with an expected payoff of \$25 or more
- C) Option 2, with an expected payoff of less than \$25
- D) Option 2, with an expected payoff of \$25 or more

Answer: D

Reference: Decision Trees

Difficulty: Hard

Keywords: decision tree, risk

AACSB: Analytic skills

82) Analyze the following decision tree. After determining the missing probabilities, identify which alternative (Option 1 or Options 2) has the higher expected payoff. What is the expected payoff?

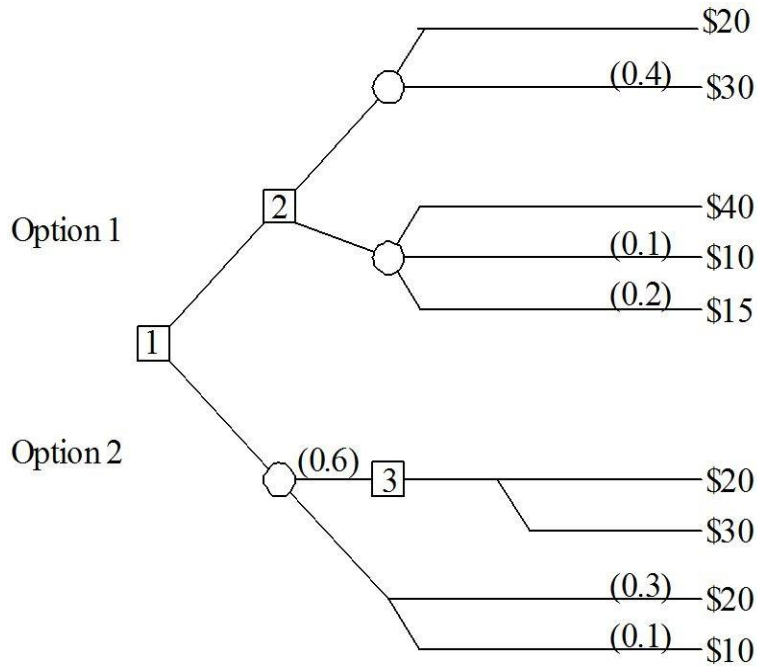

- A) Option 1, with an expected payoff of less than \$25
- B) Option 1, with an expected payoff of \$25 or more
- C) Option 2, with an expected payoff of less than \$25
- D) Option 2, with an expected payoff of \$25 or more

Answer: B

Reference: Decision Trees

Difficulty: Hard

Keywords: decision tree, risk

AACSB: Analytic skills

83) Analyze the following decision tree. After determining the missing probabilities, identify which alternative (Option 1 or Options 2) has the higher expected payoff. What is the expected payoff?

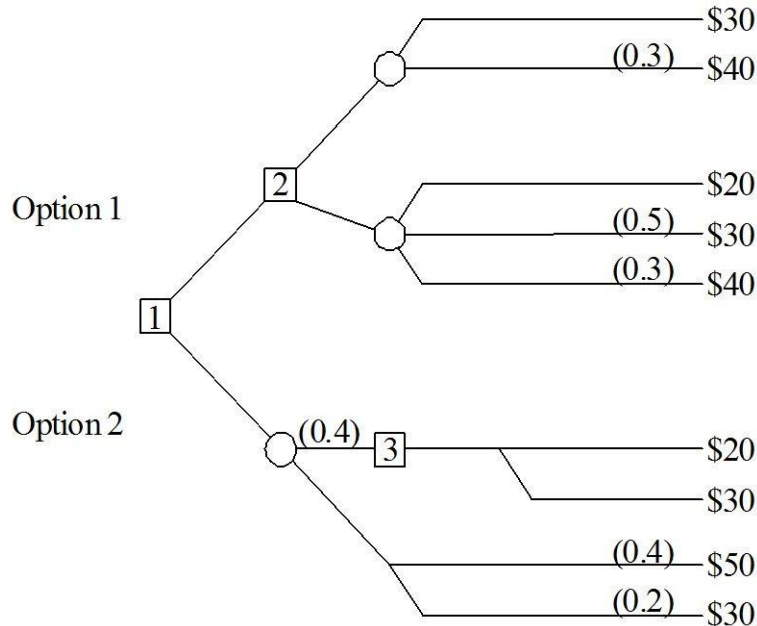

- A) Option 1, with an expected payoff of less than \$35
- B) Option 1, with an expected payoff of no less than \$35
- C) Option 2, with an expected payoff of less than \$35
- D) Option 2, with an expected payoff of more than \$35

Answer: D

Reference: Decision Trees

Difficulty: Hard

Keywords: decision tree, risk

AACSB: Analytic skills

84) The _____ is the volume at which total revenues equal total costs.

Answer: break-even quantity

Reference: Break-Even Analysis

Difficulty: Moderate

Keywords: break-even quantity

85) _____ is the portion of total cost that remains constant regardless of changes in levels of output.

Answer: Fixed cost

Reference: Break-Even Analysis

Difficulty: Moderate

Keywords: fixed cost

86) _____ is a technique for systematically changing parameters in a model to determine the effects of such changes.

Answer: Sensitivity analysis

Reference: Break-Even Analysis

Difficulty: Moderate

Keywords: sensitivity analysis

87) _____ is a general approach to decision making when the outcomes associated with alternatives are often in doubt.

Answer: Decision theory

Reference: Decision Theory

Difficulty: Moderate

Keywords: decision theory, alternatives

88) In decision theory, the different courses of action that a decision maker can choose are called _____.

Answer: alternatives

Reference: Decision Theory

Difficulty: Moderate

Keywords: alternatives, decision theory

89) A chance event that has an impact on the outcome of the choice but is not under the manager's control is called a(n) _____.

Answer: state of nature

Reference: Decision Theory

Difficulty: Moderate

Keywords: event, state of nature

90) A(n) _____ shows the amount of revenue for each alternative if each possible event occurs.

Answer: payoff table

Reference: Decision Theory

Difficulty: Moderate

Keywords: payoff table, event, alternatives

91) The decision rule _____ is also referred to as the pessimist's criterion.

Answer: maximin

Reference: Decision Theory

Difficulty: Moderate

Keywords: maximin, pessimist, decision rule

92) The decision rule _____ is also referred to as the optimist's criterion.

Answer: maximax

Reference: Decision Theory

Difficulty: Moderate

Keywords: maximax, optimist, decision rule

93) The decision rule _____ chooses the alternative that is the "best of the best."

Answer: maximax

Reference: Decision Theory

Difficulty: Moderate

Keywords: maximax, decision rule

94) An analyst that can't assign probabilities to the events must be engaged in decision-making under _____.

Answer: uncertainty

Reference: Decision Theory

Difficulty: Moderate

Keywords: uncertainty, events

95) The decision rule _____ chooses the alternative with the best weighted payoff.

Answer: Laplace

Reference: Decision Theory

Difficulty: Moderate

Keywords: Laplace, decision rule

96) A(n) _____ is the difference between a given payoff and the best payoff for a given state of nature.

Answer: regret

Reference: Decision Theory

Difficulty: Moderate

Keywords: minimax, decision, regret

97) If probabilities for events can be estimated, then the situation faced by the decision maker is called _____.

Answer: decision making under risk, risk

Reference: Decision Theory

Difficulty: Moderate

Keywords: decision making, risk

98) A(n) _____ is a schematic model of alternatives available to the decision maker, along with their possible consequences.

Answer: decision tree

Reference: Decision Trees

Difficulty: Moderate

Keywords: decision tree, alternatives

99) A(n) _____ is typically used to represent an event node in a decision tree.

Answer: circle

Reference: Decision Trees

Difficulty: Moderate

Keywords: decision tree, event node

100) The _____ nodes have probabilities associated with them in a decision tree.

Answer: event (or circle)

Reference: Decision Trees

Difficulty: Moderate

Keywords: decision tree, event node

101) Decision trees are typically used in the situation of decision making under _____.

Answer: risk

Reference: Decision Trees

Difficulty: Moderate

Keywords: decision tree, alternatives, risk, DMUR

102) What assumptions are made when using break-even analysis?

Answer: Break-even analysis is useful to evaluate new or existing products or services and to compare production methods; however, decision makers who use this model make assumptions. Typically, single values are provided for fixed and variable cost and for revenues. This results in wonderfully straight lines that do not reflect realities such as start-up costs, economies of scale, price breaks offered to volume purchasers, and diseconomies of scale.

Reference: Break-Even Analysis

Difficulty: Easy

Keywords: break-even analysis, fixed cost, variable cost

103) Why should a decision maker engage in sensitivity analysis?

Answer: Sensitivity analysis is a technique for systematically changing parameters in a model to determine the effects of such changes. Models are created with assumptions and the results given by the use of a model are only as good as the assumptions that were made in creating the model. For techniques such as the Laplace criterion, if the probability for one state of nature or payoff was estimated incorrectly, the result might suggest a choice far different from the choice made if a better estimate were used.

Reference: Decision Theory

Difficulty: Easy

Keywords: sensitivity analysis

104) The site selection team you formed last quarter meets with you in the conference room to present the results of their thoughtful analysis. They have collectively logged 200,000 frequent flyer miles while conducting their investigation. The conference room table sags under the weight of their massive report and all team members sport deep tans. As the leader drones on about their completely objective approach to the problem he projects a slide containing the following information about their location of choice.

Rio de Janeiro	Weight (A)	Score (B)	Weighted Score (A x B)
Infrastructure	20	8	160
Utility Costs	25	5	125
Labor Skill	25	6	150
Labor Cost	20	7	140
Political climate	10	4	40
	Final Weighted Score		615

What questions do you, a conscientious vice-president level executive, have for the team about this portion of their analysis?

Answer: The preference matrix provides a vehicle for converting a subjective decision into a decision that appears more objective. This analysis should be questioned regarding the choice of criteria, the weights assigned to the criteria, and the scores assigned to each alternative. How did the committee settle on infrastructure, utility cost, labor skill, labor cost, and political climate as the most important factors? How were weights and scores assigned? If this is the only site's results presented, then what was the margin of victory and what were the other sites? Comparing scores is also an issue; there is temptation to treat the scores as having greater significance than they actually carry.

Reference: Preference Matrix

Difficulty: Moderate

Keywords: preference matrix, criteria, weight

105) List and describe decision rules that are used for decision making under uncertainty.

Answer: The decision rules include maximin, maximax, Laplace, and minimax regret. Maximin chooses the "best of the worst" and is for the pessimist. Maximax chooses the "best of the best" and is for the optimist. Laplace chooses the best weighted payoff and is for the realist. Minimax regret chooses the best "worst regret."

Reference: Decision Theory

Difficulty: Moderate

Keywords: Laplace, minimax, maximax, minimax, regret

106) Provide an example of two or more events where you as a decision maker would truly be engaged in decision making under uncertainty. Why are you incapable of deciding which event is more likely than the other(s)?

Answer: Answers will vary

Reference: Decision Theory

Difficulty: Moderate

Keywords: uncertainty, events

107) Given a payoff table in a decision making under risk scenario, what value is derived from applying all four criteria presented in your book and selecting the alternative that is chosen the most times by the four criteria?

Answer: The decision rules include maximin, maximax, Laplace, and minimax regret. Maximin chooses the "best of the worst" and is for the pessimist. Maximax chooses the "best of the best" and is for the optimist. Laplace chooses the best weighted payoff and is for the realist. Minimax regret chooses the best "worst regret." Applying an overall winner to the four criteria might permit the decision maker to satisfy the appetite for risk of the greatest number of stakeholders. The mindsets that drive a decision maker towards one criterion or another are such that an average of these approaches most probably will hold no additional cachet for any single optimist or pessimist or centrist.

Reference: Decision Theory

Difficulty: Moderate

Keywords: Laplace, minimax, maximax, minimax, regret

108) Under what conditions can decision trees be useful?

Answer: Decision trees are useful when there is uncertainty and sequential decisions are involved.

Reference: Decision Trees

Difficulty: Easy

Keywords: decision tree, sequential decisions

109) A single factory produces two different products during each half of the year with equivalent fixed cost; from January through June they produce Product A and from July through December they produce Product B. Product A costs twice as much to produce and is sold at twice the price of Product B. Derive an expression relating the break-even quantity of Product A to that of Product B.

Answer:

$$Q_A = \frac{F_A}{p_A - c_A}$$

$$Q_B = \frac{F_B}{p_B - c_B}$$

$$F_A = F_B \text{ (same factory)}$$

$$p_A = 2p_B \text{ (A sells for twice as much as B)}$$

$$c_A = 2c_B \text{ (A costs twice as much as B)}$$

$$Q_A = \frac{F_B}{2p_B - 2c_B} = \frac{1}{2} \left(\frac{F_B}{p_B - c_B} \right) = \frac{1}{2} (Q_B)$$

The break-even point for Product A is half the quantity for Product B.

Reference: Break-Even Analysis

Difficulty: Hard

Keywords: break-even quantity, fixed cost, variable cost

AACSB: Analytic skills

110) A new minor league baseball team is coming to town and the owners have decided to build a new stadium, either small or large. The success of the team with regard to ticket sales will be either high or low with probabilities of 0.75 and 0.25, respectively. If demand for tickets is high, the large stadium would provide a payoff of approximately \$20 million. If ticket sales are low, the loss on the large stadium would be \$5 million. If a small stadium is constructed, and ticket sales are low, the payoff is \$500,000 after deducting the cost of construction. If ticket sales are high, the team can choose to build an upper deck, or to maintain the existing facility. Expanding the stadium in this scenario has a payoff of \$10 million, whereas maintaining the same number of seats has a payoff of only \$3 million.

- Draw a decision tree for this problem.
- What should management do to achieve the highest expected payoff?

Answer:

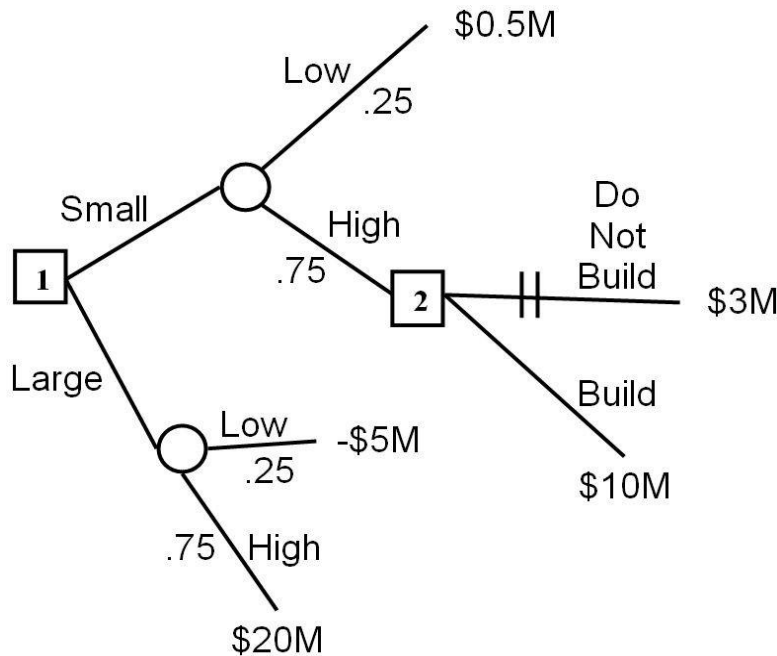

Small Stadium: $0.25(\$500,000) + 0.75(\$10,000,000) = \$7,625,000$

Large Stadium: $0.25(-\$5,000,000) + 0.75(\$20,000,000) = \$13,750,000$

Select the large stadium based on expected value.

Reference: Decision Trees

Difficulty: Moderate

Keywords: decision tree, risk

AACSB: Analytic skills

111) The Hill O'Beans Coffee Company operates a chain of coffee shops downtown and has decided to open a new store. The demand will be weak, fair, or strong; probabilities are 0.25, 0.30, and 0.45, respectively.

If the company installs a small booth that sells only coffee, the associated payoffs are -\$25,000; 25,000; and \$100,000 for weak, fair, and strong demand. If the company chooses an expanded facility that offers sandwiches and breakfast foods, it must build a kitchen and rent additional space. The payoffs for an expanded facility are -\$200,000, -\$25,000, and \$500,000.

- Draw a decision tree for this problem.
- What should management do to achieve the highest expected payoff?

Answer:

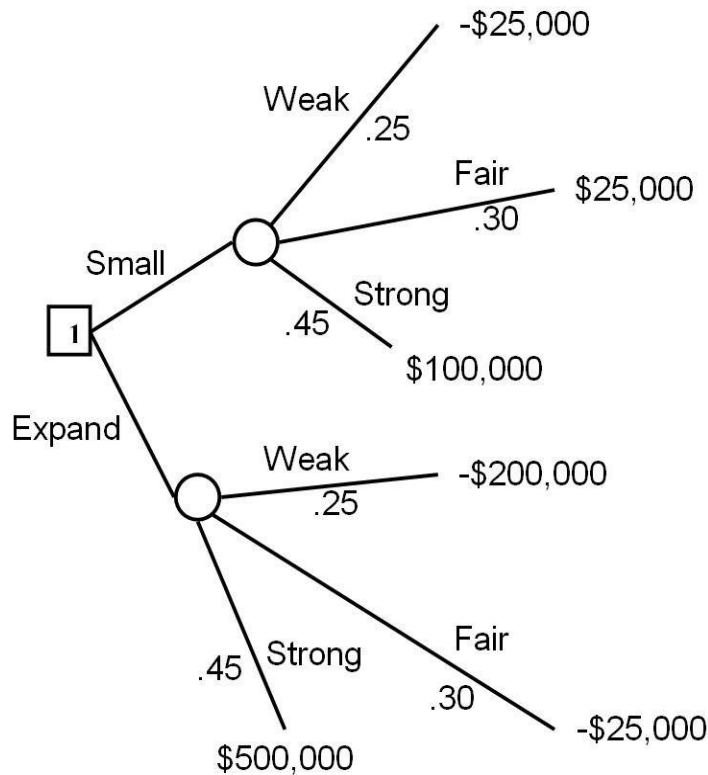

Small: $.25(<25,000>) + .30(25,000) + .45(100,000) = 46,250$

Expand: $.25(<200,000>) + .30(<25,000>) + .45(500,000) = 167,500$

Therefore, expand based on the expected value.

Reference: Decision Trees

Difficulty: Moderate

Keywords: decision tree, risk

AACSB: Analytic skills

112) Keith Monroe is deciding among four alternatives and fleshes out the decision tree shown below. He has developed excellent estimates of payoffs but admits he has no clue about the probabilities for the two states of nature. He wants to cover all of his bases, so he would like to calculate the probability of high demand for which each alternative is superior. Analyze this situation and make recommendations for him. He promises to cut you in for 30% of the profits if you can show him how to calculate the ranges.

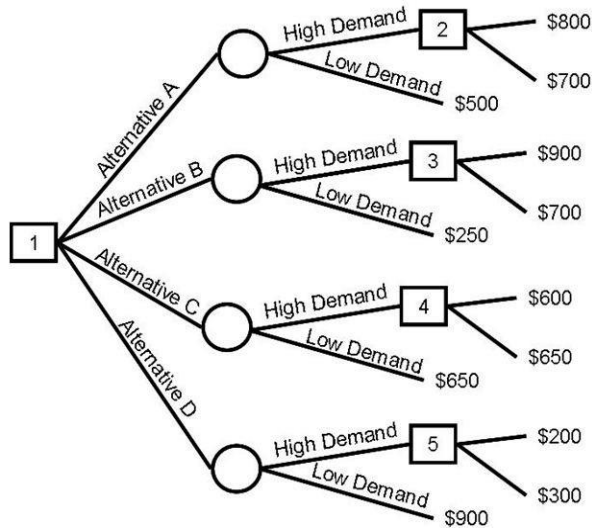

Answer: Approaches to this problem may vary. The value for each alternative is given by this set of equations:

$$\text{Alternative A: } 800p_{\text{HIGH}} + 500p_{\text{LOW}} = V_A$$

$$\text{Alternative B: } 900p_{\text{HIGH}} + 250p_{\text{LOW}} = V_B$$

$$\text{Alternative C: } 650p_{\text{HIGH}} + 650p_{\text{LOW}} = V_C$$

$$\text{Alternative D: } 300p_{\text{HIGH}} + 900p_{\text{LOW}} = V_D$$

$$p_{\text{LOW}} = 1 - p_{\text{HIGH}}$$

$$\text{Alternative A: } 800p_{\text{HIGH}} + 500(1 - p_{\text{HIGH}}) = V_A = 300p_{\text{HIGH}} + 500$$

$$\text{Alternative B: } 900p_{\text{HIGH}} + 250(1 - p_{\text{HIGH}}) = V_B = 650p_{\text{HIGH}} + 250$$

$$\text{Alternative C: } 650p_{\text{HIGH}} + 650(1 - p_{\text{HIGH}}) = V_C = 650$$

$$\text{Alternative D: } 300p_{\text{HIGH}} + 900(1 - p_{\text{HIGH}}) = V_D = -600p_{\text{HIGH}} + 900$$

The second set of equations create lines as displayed in the graph, which shows the expected monetary value of the four alternatives plotted against the probability of high demand as it ranges from 0 to 1.

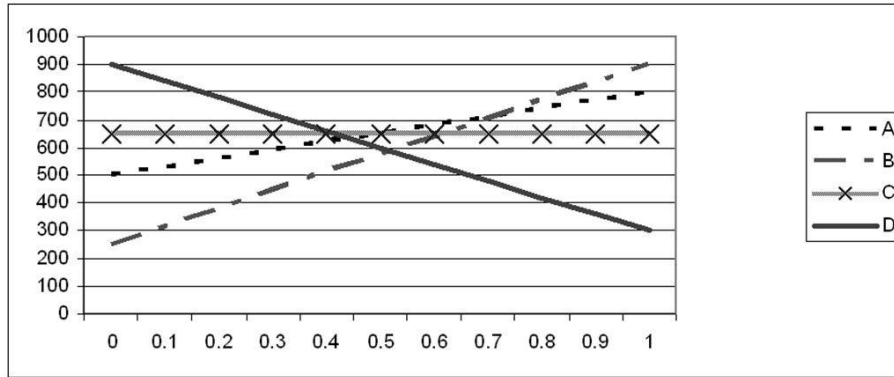

The graph shows that Alternative D is initially superior, giving way to Alternative C, which yields to Alternative A, which is supplanted by Alternative B as the probability of high demand increases from 0 to 1. These three intersections on the graph can be determined by setting up three sets of simultaneous equations.

D & C

$$V_D = -600p_{HIGH} + 900 = 650 = V_C$$

$$-600p_{HIGH} = -250$$

$$p_{HIGH} = .41\bar{6}$$

C & A

$$V_C = 650 = 300p_{HIGH} + 500 = V_A$$

$$150 = 300p_{HIGH}$$

$$p_{HIGH} = .5$$

A & B

$$V_A = 300p_{HIGH} + 500 = 650p_{HIGH} + 250 = V_B$$

$$250 = 350p_{HIGH}$$

$$p_{HIGH} = .714286$$

To summarize:

Range	Best Alternative
0.0 - 0.4167	D
0.4167 - 0.5	C
0.5 - 0.7143	A
0.7143 - 1.0	B

Reference: Decision Trees

Difficulty: Hard

Keywords: decision tree, risk

AACSB: Analytic skills

113) A company is screening ideas for new services. Four alternative service ideas are being considered. Management identified four criteria and weighted them as follows: A = 40, B = 30, C = 20, and D = 10. They have also come up with scored values for the five alternatives and the four criteria as shown following. Management has decided that if an alternative has less than a total scored value of 600, it should automatically be rejected. Use the preference matrix technique to determine which idea should be accepted.

Alternative Criteria	1	2	3	4
A	9	8	4	3
B	6	7	5	10
C	9	5	8	6
D	2	5	9	8

Answer:

Alternative 1

A
B
C
D

Weight (A)	Score (B)	Weighted Score (A x B)
40	9	360
30	6	180
20	9	180
10	2	20
Final Weighted Score		740

Alternative 2

A
B
C
D

Weight (A)	Score (B)	Weighted Score (A x B)
40	8	320
30	7	210
20	5	100
10	5	50
Final Weighted Score		680

Alternative 3

A
B
C
D

Weight (A)	Score (B)	Weighted Score (A x B)
40	4	160
30	5	150
20	8	160
10	9	90
Final Weighted Score		560

Alternative 4

A
B
C
D

Weight (A)	Score (B)	Weighted Score (A x B)
40	3	120
30	10	300
20	6	120
10	8	80
Final Weighted Score		620

Therefore, select Alternative 1, with a weighted score of 740.

Reference: Break-Even Analysis

Difficulty: Moderate

Keywords: break-even quantity, fixed cost, variable cost, total cost

AACSB: Analytic skills

114) A manufacturing firm is considering an entirely new product that will require additional capital equipment, training, and an addition to their existing facility that will cost \$50,000 per year. The projected retail price is \$45 per unit, and the variable cost of production is \$12.50. What is the break-even for this product? Solve using both the graphical and algebraic approaches.

Answer:

$$Q = \frac{F}{p - c} = \frac{\$50,000/\text{year}}{\$45/\text{unit} - \$12.50/\text{unit}} = 1538.46 \text{ units/year}$$

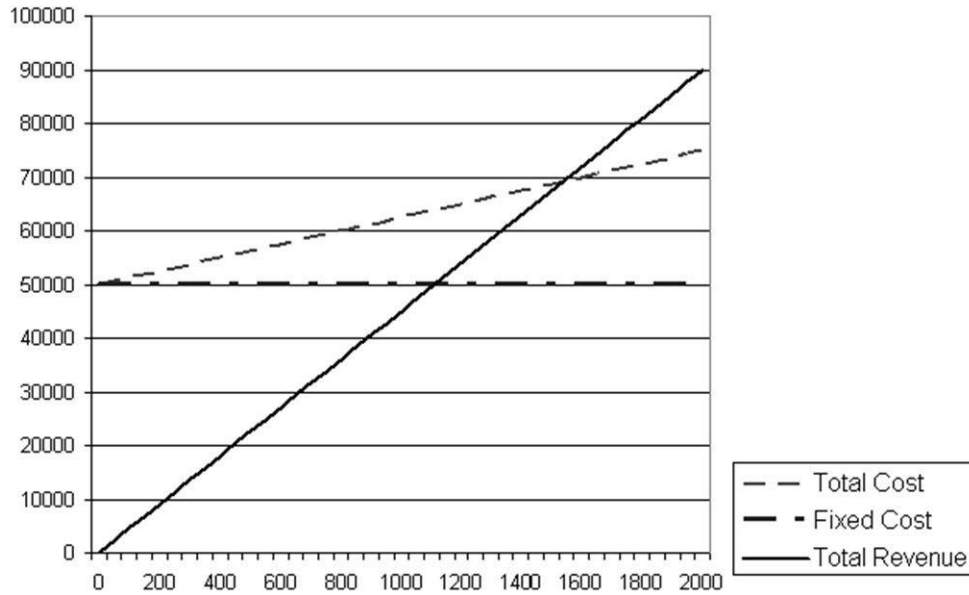

Reference: Break-Even Analysis

Difficulty: Moderate

Keywords: break-even quantity, fixed cost, variable cost, total cost

AACSB: Analytic skills

115) A manufacturing firm is considering whether to produce or outsource the production of a new product. If they produce the item themselves, they will incur a fixed cost of \$950,000 per year, but if they outsource overseas there will be a \$1.5 million cost per year. The advantage of outsourcing overseas is the variable cost of 95¢ per unit, which is a fraction of their \$43/unit cost in their own union shop. Regardless where these devices are made, they will sell for \$98 each. What is the break-even quantity for each alternative? Solve this problem graphically and algebraically.

Answer:

$$\text{Overseas: } \frac{F}{p - c} = \frac{\$1,500,000/\text{year}}{\$98/\text{unit} - \$0.95/\text{unit}} = 15,455.95 \text{ units}$$

$$\text{In-house: } \frac{F}{p - c} = \frac{\$950,000/\text{year}}{\$98/\text{unit} - \$43/\text{unit}} = 17,272.73 \text{ units}$$

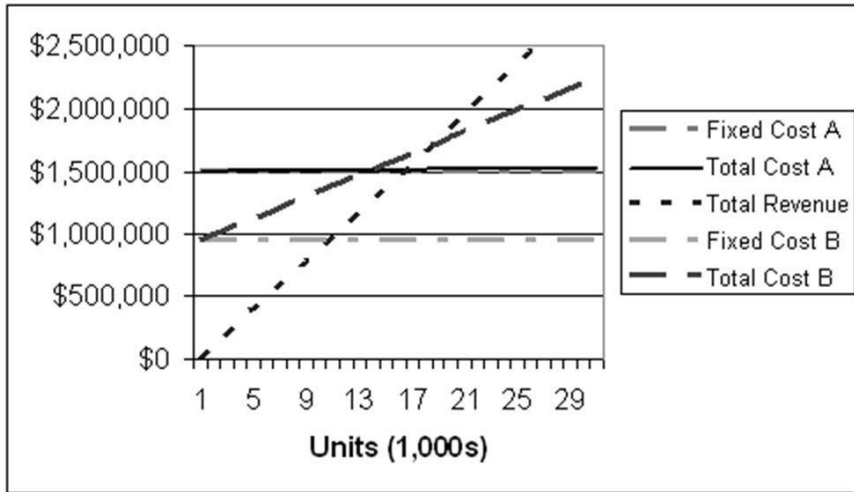

Reference: Break-Even Analysis

Difficulty: Moderate

Keywords: break-even quantity, fixed cost, variable cost, total cost

AACSB: Analytic skills

116) A company that is introducing a new product has to choose between four marketing plans, A through D. The marketing plans are forecasted to have varying payoffs, depending on the level of advertising. The probability of high demand is 0.6 and of low demand 0.4. Use the following decision rules to select the marketing plan: maximin, maximax, minimax regret, Laplace, and expected value.

Marketing Plan	Payoff (Dollars)	
	High Demand	Low Demand
A	100,000	25,000
B	50,000	45,000
C	75,000	35,000
D	125,000	10,000

Answer:

	1: High Demand	2: Low Demand	3: Event 3	4: Event 4	5: Event 5
Probabilities---->					
A	100,000	25,000			
B	50,000	45,000			
C	75,000	35,000			
D	125,000	10,000			

Use the dropdown list to select the decision rule >>> Maximin ▼

Selected decision rule indicates you should select: B

Payoff \$45,000

	1: High Demand	2: Low Demand	3: Event 3	4: Event 4	5: Event 5
Probabilities---->					
A	100,000	25,000			
B	50,000	45,000			
C	75,000	35,000			
D	125,000	10,000			

Use the dropdown list to select the decision rule >>> Maximax ▼

Selected decision rule indicates you should select: D

Payoff \$125,000

	1: High Demand	2: Low Demand	3: Event 3	4: Event 4	5: Event 5
Probabilities---->					
A	100,000	25,000			
B	50,000	45,000			
C	75,000	35,000			
D	125,000	10,000			

Use the dropdown list to select the decision rule >>> Minimax Regret

Selected decision rule indicates you should select: A

Regret \$25,000

	1: High Demand	2: Low Demand	3: Event 3	4: Event 4	5: Event 5
Probabilities---->					
A	100,000	25,000			
B	50,000	45,000			
C	75,000	35,000			
D	125,000	10,000			

Use the dropdown list to select the decision rule >>> Laplace

Selected decision rule indicates you should select: D

Weighted Payoff \$67,500

	1: High Demand	2: Low Demand	3: Event 3	4: Event 4	5: Event 5
Probabilities---->	0.6	0.4			
A	100,000	25,000			
B	50,000	45,000			
C	75,000	35,000			
D	125,000	10,000			

Use the dropdown list to select the decision rule >>> Expected Value

Selected decision rule indicates you should select: D

Expected Payoff \$79,000

Reference: Decision Theory

Difficulty: Moderate

Keywords: maximin, maximax, Laplace, minimax regret, expected value

AACSB: Analytic skills

117) A company that is introducing a new product has to choose between four different manufacturing methods, referred to as methods A, B, C and D. Depending on the demand for the product, they have forecast different levels of expenses for the year (values are in thousands). The company has identified three possible states of nature for economic growth, and named them High, Medium, and low. Which alternative is best in accordance with an optimistic outlook? Which alternative is best according to a pessimist?

	High	Medium	Low
Method A	\$450	\$670	\$780
Method B	\$950	\$320	\$200
Method C	\$375	\$575	\$775
Method D	\$800	\$400	\$300

Answer: The optimistic outlook is Method B; the pessimistic outlook is Method C; the equally likely perspective is Method B; the minimax regret choice is Method C

Reference: Decision Theory

Difficulty: Moderate

Keywords: maximax, decision theory

AACSB: Analytic skills

118) A company faces a fixed cost of \$568 and sells items at a 50% markup on their cost of \$12. What is their break-even point in both units and dollar sales?

Answer: The 50% markup means their revenue per unit is \$18 for a \$6 profit. Their break-even point is $568/6 = 94.67$ units or \$1704.06.

Reference: Decision Theory

Difficulty: Easy

Keywords: break-even

AACSB: Analytic skills

119) Pops has a cost function of $3x^2 - 25x + 34,374.74$ and a revenue function of $5x^2$. Using Excel (or algebra), determine a breakeven point. What is their fixed cost? What is their break-even point in both units and dollar sales?

Answer: The fixed cost must be \$34,374.74 since it is the argument in the cost function that does not vary with production volume. The breakeven point is 125 units, at which point the total revenue is \$78,124.38. The other root of the quadratic equation represents negative production and is not a valid answer regardless of the efficiency of their reverse logistics program.

$$3x^2 + 25x + 34,374.74 = 5x^2$$

$$2x^2 - 25x - 34,374.74 = 0$$

$$x = \frac{25 \pm \sqrt{(-25)^2 - 4 \times 2 \times (-34,374.74)}}{2 \times 2}$$

$$x_1 = -125; x_2 = 137.5$$

Reference: Decision Theory

Difficulty: Moderate

Keywords: break-even

AACSB: Analytic skills