

**SOLUTIONS MANUAL**

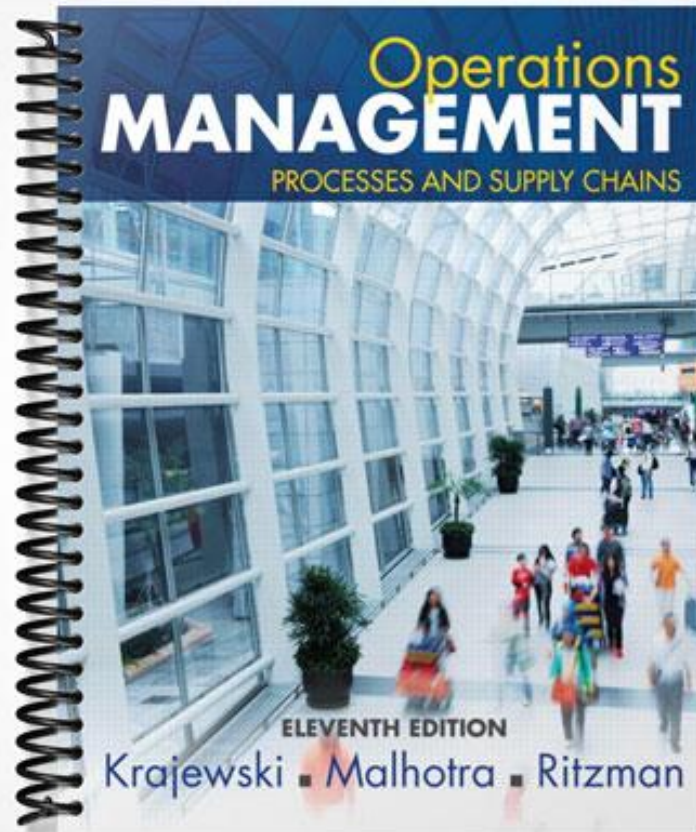

## Chapter

# 2 Process Strategy and Analysis

### DISCUSSION QUESTIONS

1. Many processes at manufacturing facilities involve customer contact. Internal customers would include those employees whose operation(s) are subsequent. Quality Control could be considered an internal customer as could design engineering or sales. Quality Control, design engineering, marketing, sales and other organizations represent the customer at various stages of any process. Customer contact can be very high, especially between production and engineering and production and quality control.
2. Some students may see this as a difference in competitive priorities. Others may see a difference in management styles. Ritz-Carlton empowers their employees and the local restaurant does not seem to empower. Ritz-Carlton believes that by having employees treat customers and other employees with respect, customer service is enhanced. A restaurant that does not allow employees to resolve a customer issue may not see enhanced customer service. The restaurant may believe that the to-go customer will be better satisfied with fast and accurate orders. The in-store customer gets the chips and salsa to utilize the time while waiting for an order to be prepared. The to-go customer has already placed that order and it is ready when the customer arrives at the pickup window.
3. eBay has considerable arrival and request variability, because its customers do not want service at the same time or at times necessarily convenient to the company. They have request variability, seeking to buy and sell an endless number of items. Their process strategy allows significant customer involvement. Their customers perform virtually all of the selling and buying processes. McDonald's instead offers a considerable variety of foods, but from a standard menu. Staffing varies, depending on the time of day. Customization is not encouraged, and the hours during which a store is open can be controlled. Its processes have virtually no customer involvement, other than placing the order, picking up condiments or napkins, and possibly disposing of plates and containers when exiting. eBay accommodates customer-introduced variability, whereas McDonald's reduces it.
4. Student answers will vary. One idea that they may come up with is the use of electronic files. The printing industry is undergoing a shift to pdf files. Medical imaging and electronic file sharing is on the immediate horizon. The trick would be to convince physicians that want to keep their pads and pencils, that their "blackberries" are their pads and pencils.

5. Selling financial services would involve considerable customer contact, and thus be a front office. Likely activities would be to work with the customer to understand customer needs, make customized presentation to the customer, and maintain a continuing relationship with the customer to react to changing customer needs. Producing monthly client fund balance reports involves little customer contact, and thus be a back office. Likely activities would be to obtain data electronically, run the report using a standardized process, forward the hard copies and electronic files to analysts, and repeat the process monthly with little variation.
6. The process of call center services is rated in the table below. The combined score is 5.6 if each is given a weight of 0.20. Arguments could be made to give more weight to a dimension such as contact intensity, although more would need to be known about the exact process. The process's alignment on the customer-contact matrix seems to fit a front office, with more jumbled work flows and process divergence. To be properly aligned, there should be considerable resource flexibility in terms of both the employees and their equipment.

<b>Dimension of Customer Contact</b>	<b>Explanation</b>	<b>Score</b>
<input type="checkbox"/> Physical presence	<input type="checkbox"/> The customer is present for such steps as working to understand customer needs and answering specific questions. Other steps such as researching product information do not involve as direct contact.	<b>1</b>
<input type="checkbox"/> What is processed	<input type="checkbox"/> The customer is the focus of what is being processed in certain steps, such as the specific product explanation. However, researching product information lies more in the category of information-based service rather than people-processing services.	<b>6</b>
<input type="checkbox"/> Contact intensity	<input type="checkbox"/> The customer is actively involved and there is high service customization process	<b>7</b>
<input type="checkbox"/> Personal attention	<input type="checkbox"/> There is considerable personal attention and confiding in working to understand customer needs and in maintaining a continuing relationship with the customer. .	<b>7</b>
<input type="checkbox"/> Method of delivery	<input type="checkbox"/> Much of the delivery is through phone-to-phone contact .	<b>7</b>

7. The answer can be debated. On one hand, relentless pressure to improve can create considerable benefits over time, and could well put a company at the top of the industry. On the other hand, small improvements do not lead to break-through solutions that might be what is needed to remain competitive, particularly in an industry marked by rapid change. However, radical change and process reengineering is strong medicine and not always needed or successful.
8. This question was inspired by a similar situation faced by Ontario Hydro-Electric. Today electricity is a commodity that competes on the basis of low-cost operations and reliability. If the environmental protection equipment is installed, HEC must either absorb the costs as a loss (immediate bankruptcy) or attempt to pass on the costs to customers and see further erosion of their market (eventual bankruptcy). HEC would probably decide to delay investment in environmental protection

equipment for as long as possible. Some discussion may focus on the issue of whether customers, as users of both electricity and the environment, are better served by competition (lower cost of electricity) or by regulated monopolies (better environment).

9. For background reading, see: Paul O’Neill, “Why the U.S. Healthcare System Is So Sick and What O.R. Can Do To Cure It.” *OR/MS Today* (December, 2007).
  - a. Although many ideas are possible, a typical response is some kind of computer order-entry system. Although we asked for blue sky ideas, these systems do cost a medium-sized hospital about \$10 million, They also solve only half of the problems, but the remaining half can become complicated and less tractable than the ones you started with.
  - b. Same set of ideas possible here as well.
  - c. Fill carts on a daily basis, more computerized information system, and so forth.
  - d. Ideas could include more nurses, or one of several ways to remind nurses when a drug is to be administered.
  - e. Many ideas are possible, ranging from mattresses on the floor to more nurse check-ins during the night.
  - f. Better sterilization procedures, better training on patient care, research on the causes of the infections, and more thorough house cleaning are just a few ideas. Students will come up with more.

## PROBLEMS

### Process Strategy Decisions

1. Dr. Gulakowicz  
 Fixed cost,  $F = \$150,000$   
 Revenue per patient,  $p = \$3,000$   
 Variable cost per unit,  $c = \$1000$   
 Break-even volume,  $Q = \frac{F}{p - c} = \frac{\$150,000}{\$3,000 - \$1000} = 75$  patients
  
2. Two manufacturing processes
  - a.  $F_1 + c_1Q = F_2 + c_2Q$   
 $\$50,000 + \$700Q = \$400,000 + \$200Q$   
 $(\$700 - \$200)Q = (\$400,000 - \$50,000)$   
 $Q = \frac{\$350,000}{\$500} = 700$  units
  - b. Choose the second process, because 800 exceeds the break-even volume.
  
3. Sebago Manufacturing

The point of indifference (at which the proposals yield the same annual cost) between:

Proposal One and Two:  $0.00 + 22x = 150,000 + 14x$

$X = 18,750$  components per year

Proposal Two and Three:  $150,000 + 14x = 450,000 + 12.50x$

$X = 200,000$  components per year

Proposal One and Three  $0.00 + 22x = 450,000 + 12.50x$

$X = 47,368.4$  components per year

Proposal one will provide the lowest annual cost if between 0 and 18,750 components are required annually, proposal two will provide the lowest annual cost if between 18,750 and 200,000 components are required annually, and Proposal three will provide the lowest annual cost if greater than 200,000 components are required annually.

## Documenting and Evaluating the Process

### 4. Custom Molds

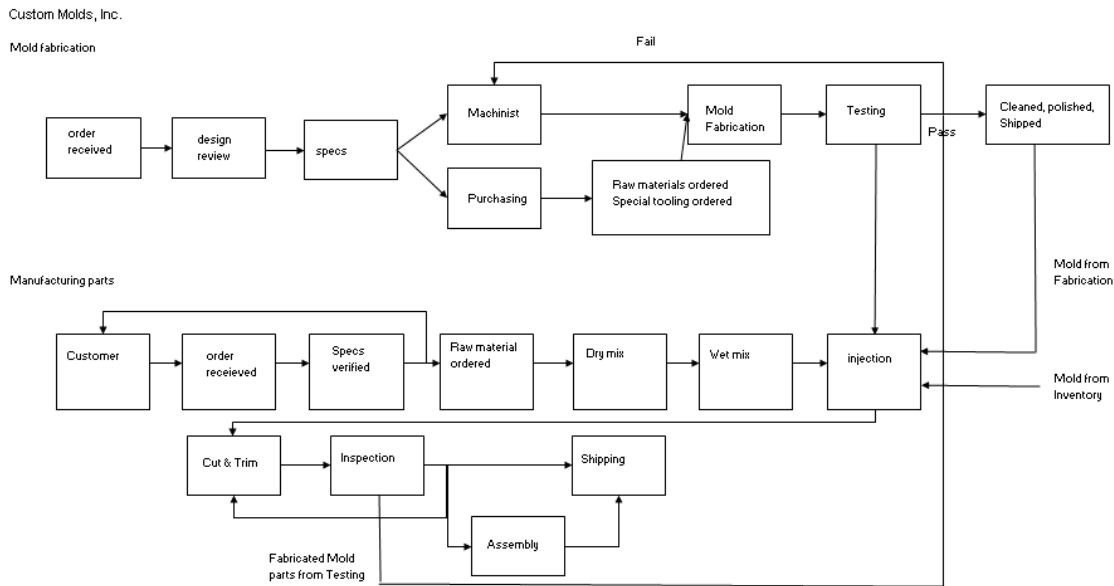

### 5. Process chart for Custom Molds with metrics

	A	B	C	D	E	F	G	H	I	J	K	L	M	N
1	<b>Process Chart for Custom Molds</b>													
2														
3	<b>Step</b>	<b>Cost (\$)</b>	<b>Time (min)</b>	<b>Time Delay (min)</b>	<b>Distance Moved (feet)</b>	<b>Scrap (%)</b>	<b>Rework (%)</b>	<b>Environmental waste (lbs)</b>	<b>Energy required (\$)</b>	<b>External customer contact (1-7)</b>	<b>Demand rate (units)</b>	<b>Process divergence (1-7)</b>	<b>Inventory (units)</b>	<b>Customer complaints (%)</b>
4	<b>Mold fabrication</b>													
5	1. Order received													
6	2. Design review													
7	3. Specs													
8	4. Machinist													
9	5. Purchasing													
10	6. Order materials and tooling													
11	7. Mold Fabrication													
12	8. Mold Testing													
13	9. Go to Step 10 or 17 as needed													
14	10. Clean, polish and ship													
15														
16	<b>Manufacturing parts</b>													
17	11. Customer order received													
18	12. Specs verified with customer													
19	13. Order materials													
20	14. Dry mix													
21	15. Wet mix													
22	16. Get mold from fabrication or inventory													
23	17. Injection													
24	18. Cut and trim													
25	19. Inspection													
26	20. Back to steps 4, 18, 21, or 22 as needed													
27	21. Assembly													
28	22. Shipping													
29	<b>TOTALS</b>													

### 6. ABC Insurance Company

ABC

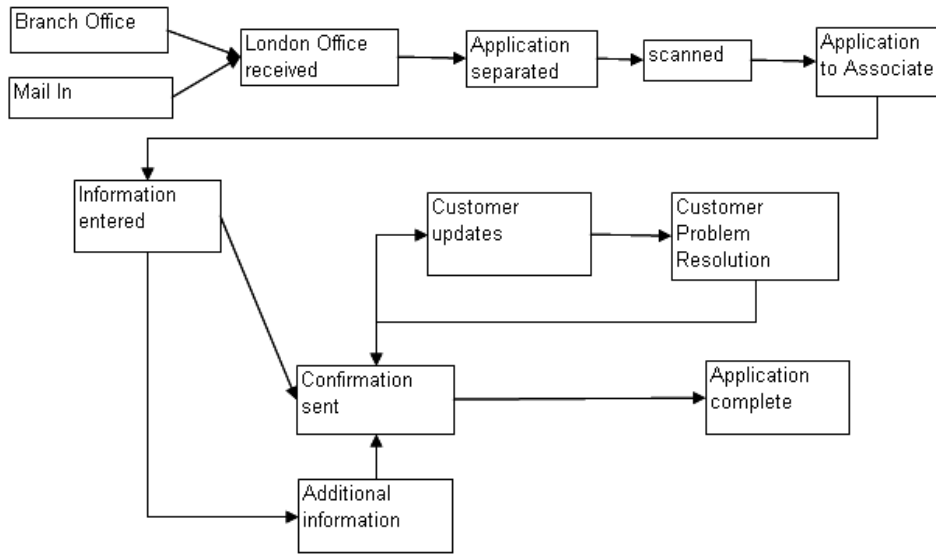

### 7. ABC Process Chart

	A	B	C	D	E	F	G	H	I	J	K	L	M	N	O	P
1	<b>Process Chart for ABC</b>															
2																
3	<b>Step</b>	<b>Cost (\$)</b>	<b>Process Time (min)</b>	<b>Time Delay (min)</b>	<b>Cumulative Elapsed Time (min)</b>	<b>Customer Error (%)</b>	<b>Associate Error (%)</b>	<b>Rework (%)</b>	<b>Environmental waste (lbs)</b>	<b>Energy required (\$)</b>	<b>External Customer Contact (1-7)</b>	<b>Applications per Week</b>	<b>Process Divergence (1-7)</b>	<b>Customer Satisfaction (1-7)</b>	<b>Number of applications in queue</b>	<b>Customer complaints (%)</b>
4	1. Branch office															
5	2. Mail in															
6	3. London office receives from Steps 1 or 2															
7	4. Application separated															
8	5. Scanned															
9	6. Application to associate															
10	7. Information entered															
11	8. Go to Steps 9 or 10 as needed															
12	9. Additional information															
13	10. Confirmation sent															
14	11. Go to Step 12 or 15 as needed															
15	12. Customer updates															
16	13. Customer problem resolution															
17	14. Go to Step 10															
18	15. Application complete															
19	<b>TOTALS</b>															

### 8. DEF Flowchart

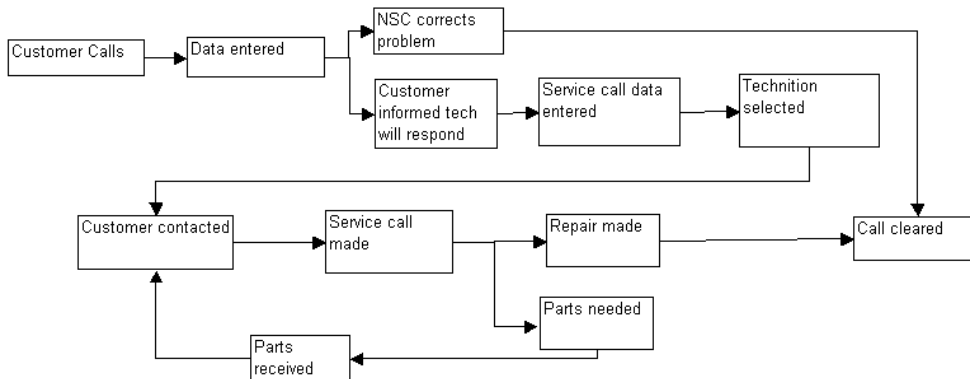

9. Big Bob's Service Blueprint  
 Service Blueprint for Big Bob's Burger Barn

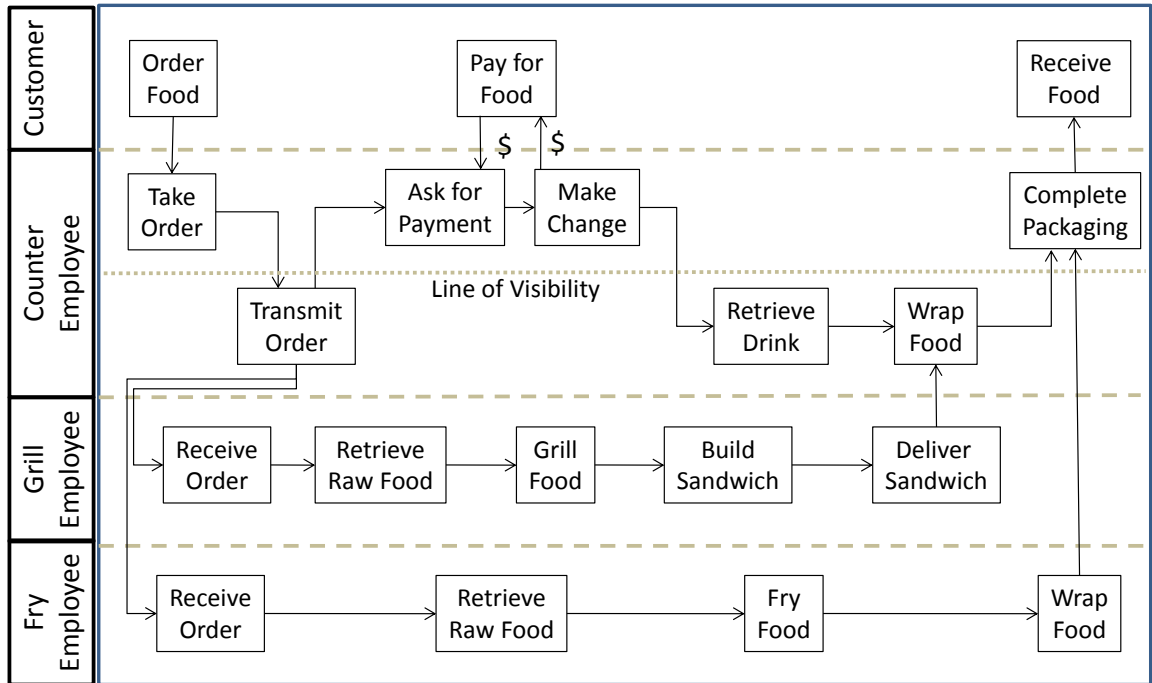

10. Referendum 13

Flowchart for yard sign assembly:

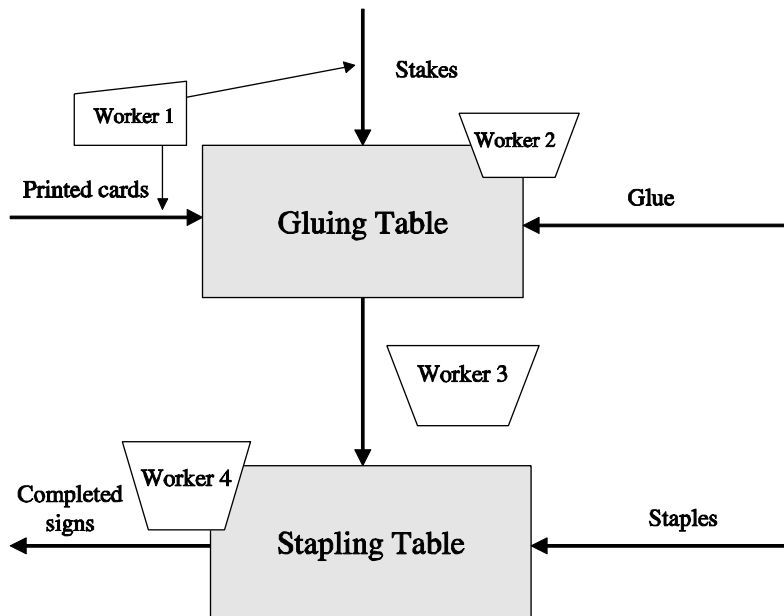



Human resource requirements:

One of many possible arrangements is to create several cells with four workers in each cell.

Worker 1 is a materials handler, bringing printed cards and stakes (say in stacks or bundles of 25) to the gluing table and taking completed signs (again in bundles of 25) to the shipping area.

Worker 2 glues printed cards to the stakes. Worker 2 is also responsible for keeping the area supplied with glue, staples, pizza, and soft drinks.

Worker 3 is also a materials handler, transferring glued signs in small quantities (a transfer batch) to the stapling table.

While worker 3 holds the material in place, Worker 4 staples the card to the stake to hold it while the glue dries. Worker 4 also inspects the staples, drives loose ones home with a hammer, and stacks completed signs in bundles of 25 for Worker 1 to take away.

Accounting for interruptions, material shortages, and chaos, each cell will complete about eight signs per minute, or about two signs per worker-minute. 10,000 signs would require about 5,000 worker-minutes, or 83.33 worker-hours. In order to accomplish this work within three hours (maximum attention span of college students)  $83.33/3 = 27.78$  or about 28 student volunteers are required to staff 7 cells.

Material requirements (for 7 cells of 4 workers each):

10,000	printed cards
10,000	stakes
32,000	staples (16 boxes of 2,000 each)
28	12-ounce bottles of wood glue
4	cases
10	pizzas

Equipment requirements:

14	tables
7	staple guns
7	hammers (to set staples)

Process chart (using *Process Chart Solver of OM Explorer*):

<b>Process:</b>	Yard sign assembly (25)	Summary			
<b>Subject:</b>	Volunteer				
<b>Beginning:</b>	Material to table	Activity	Number of Steps	Time (min)	Distance (ft)
<b>Ending:</b>	Completed signs removed	Operation ●	2	6.2	
	<input type="button" value="Insert Step"/>	Transport ➡	4	4.0	155
	<input type="button" value="Append Step"/>	Inspect ■	1	1.0	
	<input type="button" value="Remove Step"/>	Delay ◐	1	1.0	
		Store ▼	2	1.5	

Step No.	Time (min)	Distance (ft)	●	➡	■	◐	▼	Step Description
1	0.5	50		X				25 printed cards to gluing table
2	0.5	50		X				25 stakes to gluing table
3	3.2		X					Glue 25 cards to 25 stakes
4	2.5	5		X				Transfer individually to stapling
5	1.0					X		Hold in position for stapling
6	3.0		X					Insert three staples per sign
7	1.0				X			Inspect staples
8	1.0						X	Stack signs into bundles of 25
9	0.5	50		X				Carry signs to shipping area
10	0.5						X	Store signs until distributed

11. Mailing to the alumni of your college  
 a. A sample process chart for 2000 letters follows.

<b>Process:</b>	Alumni Mailing	Summary						
<b>Subject:</b>	Letters and envelopes							
<b>Beginning:</b>	Process letter	Activity	Number of Steps	Time (min)	Distance (ft)			
<b>Ending:</b>	Place stamp on envelope	Operation ●	5	0.57				
	Insert Step	Transport →						
	Append Step	Inspect ■						
	Remove Step	Delay ◐						
		Store ▼						
Step No.	Time (min)	Distance (ft)	●	→	■	◐	▼	Step Description
1	0.20		X					Process letter
2	0.12		X					Fold letter
3	0.10		X					Stuff into correct envelope
4	0.05		X					Seal envelope
5	0.10		X					Place stamp on envelope

- b. Total time for 2000 letters =  $[(0.57 \text{ min}) / 60 \text{ min per hour}] \times 2000 \text{ letters} = 19 \text{ hours}$ . The cost to process 2000 letters =  $(\$8/\text{hr})(19 \text{ hr}) = \$152$ .
- c. Changes that would reduce the time and cost of the process:
- A letterhead with “Dear Alumnus” will make step 1 (process letter) not necessary, saving 400 minutes and \$53.33 [ $\$8(400/60)$ ].
  - With mailing labels, step 1 involves matching the letters with labels rather than with addressed envelopes, but now we must stick the label to the envelope. We do everything we did before plus the extra step. The time would increase by 200 minutes and cost \$26.66 [ $\$8(200/60)$ ] more.
  - Prestamped envelopes will eliminate step 5 and save 200 minutes and \$26.67 [ $\$8(200/60)$ ].
  - If envelopes are to be stamped by a postage meter, it will take, 10 minutes [ $2000/200$ ]. This results in a savings of 190 minutes and \$25.33 [ $\$8(190/60)$ ].
  - Window envelopes eliminate the need to match envelopes to letters, resulting in a savings of \$53.33.
- d. Using the letter with “Dear Alumnus” may reduce the effectiveness of the project because it would be less personal. This concern goes also for the use of mailing labels.

- e. Although including a preaddressed envelope will increase time and cost of the process, alumni may be more likely to contribute if they have an envelope available to them.

12. Gasoline Stations

- a. The gas station in part (b) has a more efficient flow from the perspective of the customer because traffic moves in only one direction through the system.
- b. The gas station in part (a) creates the possibility for a random direction of flow, thereby causing occasional conflicts at the gas pumps.
- c. At the gas station in part (b) a customer could pay from the car. However, this practice could be a source of congestion at peak periods.

13. Just Like Home Restaurant

- a. The summary of the process chart should appear as follows:

Activity	Number of Steps	Time (min)	Distance (ft)
Operation ●	6	1.70	
Transport ➡	6	0.80	31
Inspect ■	1	0.25	
Delay ◐	1	0.50	
Store ▼	--	--	

- b. Each cycle of making a single-scoop ice cream cone takes  $1.70 + 0.80 + 0.25 + 0.50 = 3.25$  minutes. The total labor cost is  $(\$10/\text{hr})[(3.25 \text{ min}/\text{cone})/60 \text{ min}](10 \text{ cones}/\text{hr})(10 \text{ hr}/\text{day})(363 \text{ day}/\text{yr}) = \$19,662.50$ .
- c. To make this operation more efficient, we can eliminate delay and reduce traveling by having precleaned scoops available. The improved process chart follows.

<b>Process:</b>	Making single-scoop ccne	Summary						
<b>Subject:</b>	Server at counter							
<b>Beginning:</b>	Walk to cone storage area	Activity	Number of Steps	Time (min)	Distance (ft)			
<b>Ending:</b>	Give to server or customer	Operation ●	5	1.65				
		Transport ➡	4	0.45	15			
		Inspect ■	1	0.25				
		Delay ◐	--	--				
		Store ▼	--	--				
<input type="button" value="Insert Step"/> <input type="button" value="Append Step"/> <input type="button" value="Remove Step"/>								
Step No.	Time (min)	Distance (ft)	●	➡	■	◐	▼	Step Description
1	0.20	5.0		X				Walk to cone storage area
2	0.05		X					Remove empty cone
3	0.10	5.0		X				Walk to scoops storage area
4	0.05		X					Remove scoop
5	0.10	2.5		X				Walk to flavor ordered
6	0.75		X					Scoop ice cream from container
7	0.75		X					Place ice cream in cone
8	0.25				X			Check for stability
9	0.05	2.5		X				Walk to order placement area
10	0.05		X					Give server or customer the cone

The cycle time is reduced to 1.65 + 0.45 + 0.25, or 2.35 minutes. The total labor cost is (\$ 10/hr)[(2.35 min/cone)/60 min](10 cones/hr)(10 hr/day)(363 day/yr) = \$14,217.50.

Therefore, the annual labor saving is \$19,662.50 – \$14,217.50 = \$5,445.00.

14. Grading Homework Steps:

1. Check each paper to identify the author of the homework, then mark each paper with section number and graduate status.
2. Sort by section and graduate status.
3. Correct and grade papers.
4. Alphabetize by section.
5. Record grades.
6. Return homework to appropriate instructor.

15. DMV

The process chart is as follows.

<b>Process:</b>	Automobile license	Summary			
<b>Subject:</b>	Customer				
<b>Beginning:</b>	Customer arrives	Activity	Number of Steps	Time (min)	Distance (ft)
<b>Ending:</b>	Customer leaves	Operation ●	5	9	
		Transport ➡	6	0	265
		Inspect ■	1	0	
		Delay ◐	4	351	
		Store ▼	1	0	
	Insert Step				
	Append Step				
	Remove Step				

Step No.	Time (min)	Distance (ft)	●	➡	■	◐	▼	Step Description
1			X					Take a number
2		50		X				Walk to waiting area
3	240					X		Wait for service
4					X			Number is called and checked
5		60		X				Walk to clerk
6	4		X					Calculate/pay city sales taxes
7		80		X				Walk to property tax area
8			X					Take a number
9	100					X		Wait for service
10		25		X				Walk to clerk
11	2		X					Calculate/pay property taxes
12		50		X				Walk to license area
13	10					X		Wait for service
14	3		X					Calculate/pay license fee
15	1					X		Abuse license clerk
16				X				Walk to car in parking lot
17							X	Crash with bus, return to step 1

The tax assessment clerks' time is being wasted by an inefficient waiting line process. Whenever the customer arrival rate approaches the service rate, a waiting line will form. While the clerk is waiting for phantom customers, service rate declines, and waiting lines become even longer. More disgusted customers leave the waiting area (renege).

This process can be improved by arranging the waiting area to work like the "batter's circle and batter's box" in baseball. Customers who have renege would be replaced before the clerks' time is wasted. Service rates would increase and waiting lines would decrease.

Typical of many service situations, the customer's anger is misguided. It is directed at the last person in the process (the license clerk), who has done nothing wrong. The customer pays for this misguided anger. While taking the one minute to abuse the license clerk, a bus approaches. Blinded by rage, the taxpayer drives his new car into the path of the oncoming bus, and the car is totaled. Now the customer will have to start the process again!

Epilogue.

It is almost sad how little exaggeration was used in creating this problem. When this location of the DMV closed, the local news announcer referred to it as “the city’s most popular place to wait in line.” This DMV process has since been replaced by an automated one-stop, one-transaction process. Just today I visited the new DMV and completed the entire process in five minutes.

16. Oil Change

- a. Each oil changing cycle takes  $16.5 + 5.5 + 5.0 + 0.7 + 0.3 = 28$  minutes.  
 The total labor cost is  
 $(\$40/\text{hr})[(28 \text{ min}/\text{service})/(60 \text{ min}/\text{hr})](2 \text{ services}/\text{hr} \times 10 \text{ hrs}/\text{day} \times 300 \text{ days}/\text{yr})$   
 $= \$112,000$
- b.  $(\$40/\text{hr}) \times (2.7 \text{ minutes saved per service}/60 \text{ min}/\text{hr}) (2 \text{ services}/\text{hr} \times 10 \text{ hrs}/\text{day} \times 300 \text{ days}/\text{yr}) = \$10,800$  saved per year

17. Time Study of Assembling Peanut Valves

Average Time =  $[14(15)+12(20)+15(25)] / (14+12+15) = 20.12$  seconds  
 Normal Time =  $20.12 \times 0.95 = 19.11$  seconds  
 Standard Time =  $19.11 \times 1.20 = 22.93$  seconds

18. Time Study of Process

Element	Performance Rating	Obs 1	Obs 2	Obs 3	Obs 4	Obs 5	Average Time	Normal Time
Element 1	70	4	3	5	4	3	3.8	2.66
Element 2	110	8	10	9	11	10	9.6	10.56
Element 3	90	6	8	7	7	6	6.8	<u>6.12</u>

Total = 19.34

Standard Time =  $19.34 \times 1.20 = \mathbf{23.21 \text{ minutes}}$

19. Work Sampling on Idle Time

a. Idle Time =  $(17+18+14+16) / (44+56+48+60) \times 100 = 31.25$  percent.

Working Time =  $100 - 31.25 = 68.75$  percent.

b. Different root causes can be explored in an expanded work sampling study, with new categories replacing idle, such as: waiting for materials, waiting for instructions, equipment failures, breaks, or conversations with co-workers.

20. Bid on Swimming Pools

a. 2<sup>nd</sup> Pool Time =  $35 \times 0.85 = 29.75$  hours

b. 4<sup>th</sup> Pool Time =  $29.75 \times 0.85 = 25.29$  hours

21. Bid Using *OM Explorer*

Time for first unit	35
Unit number	5
Time for unit 5	24.02
Cumulative average time per unit	28.22

The 5<sup>th</sup> pool should take just over 24 hours, with the cumulative average time for all five pools being 28.2 hours. Total Time =  $(28.2)(5) = 141$  hours. The learning curve follows.

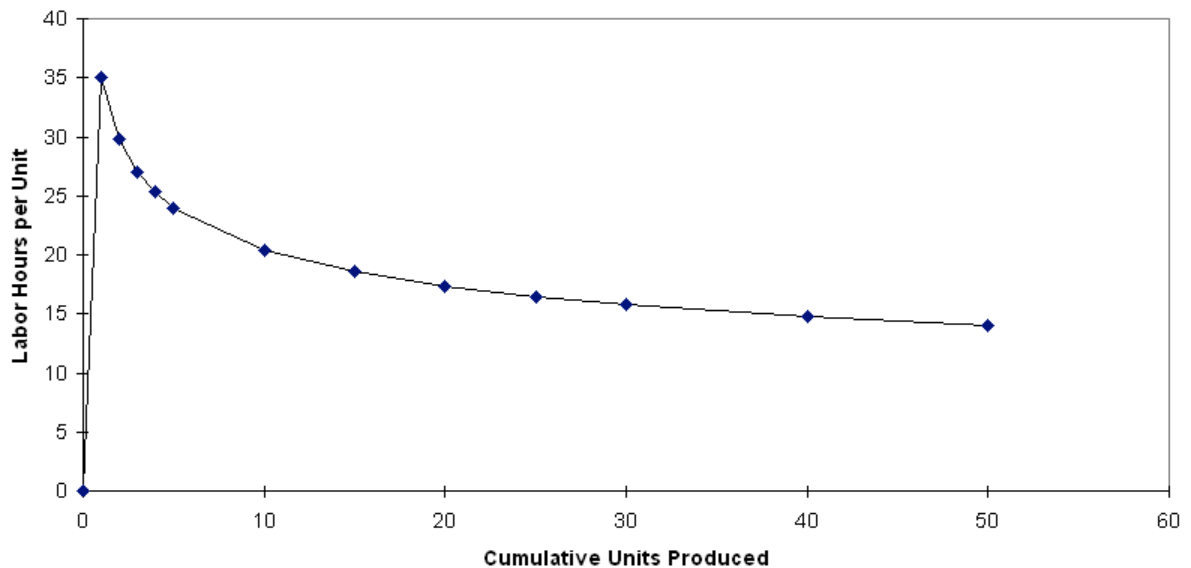



22. Rain Tite

a. Production time on the manual line

- 1st window = 30 minutes
- 2nd window =  $30 \times .90 = 27.00$  minutes
- 4th window =  $27 \times .90 = 24.30$  minutes
- 8th window =  $24.3 \times .90 = 21.87$  minutes
- 16th window =  $21.87 \times .90 = 19.68$  minutes

b. Production time on the semi-automated line

- 1st window = 45 minutes
- 2nd window =  $45 \times .75 = 33.75$  minutes
- 4th window =  $33.75 \times .75 = 25.31$  minutes
- 8th window =  $25.31 \times .75 = 18.98$  minutes
- 16th window =  $18.98 \times .75 = 14.24$  minutes

As displayed in the graph below, after 4 windows produced, the employee on the semi-automated line will be able to build a window more quickly than an employee on the manual line.

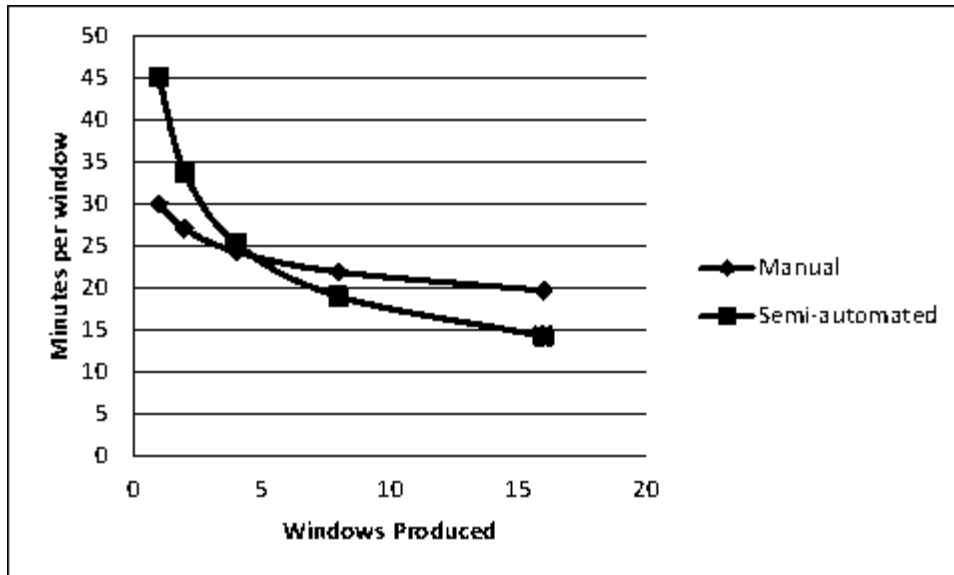

23. Perrotti's Pizza Pareto chart

- a. Although the frequency of partly eaten pizza is low, it is a serious quality problem because it is deliberate rather than accidental. It is likely to cause extreme loss of goodwill. A common root cause of many of these problems could be miscommunication between the customer and the order taker, between the order taker and production and between production and distribution. This chart was created using *the Bar, Pareto, and Line Charts Solver of OM Explorer*.

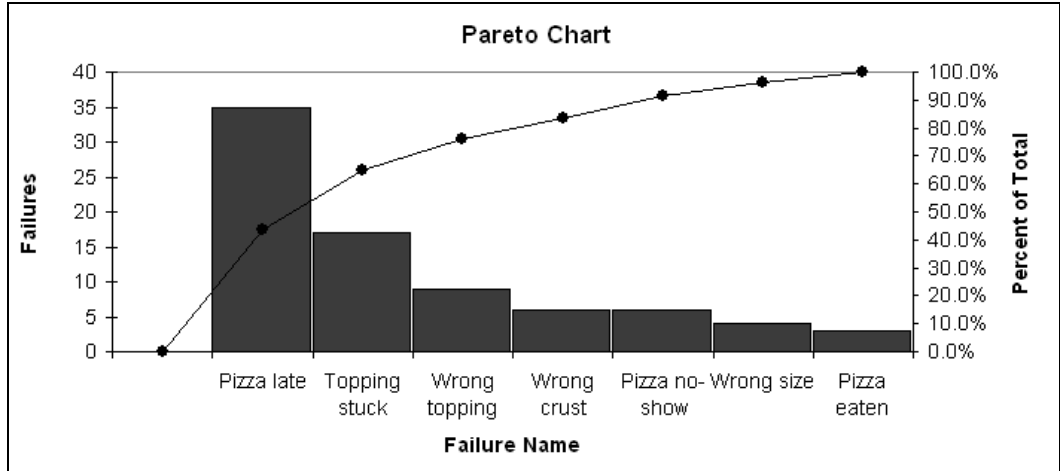

b. Cause-and-effect diagram

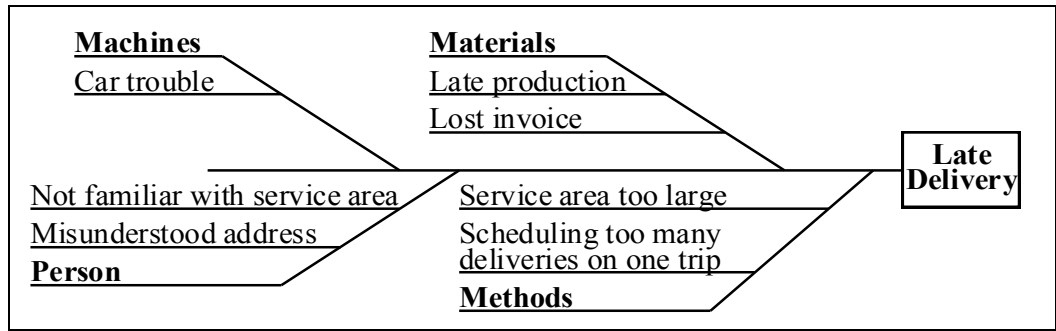

24. Smith, Schroeder, and Torn (short moves)

- a. The tally sheet given in the problem is essentially a horizontal bar chart. To create a Pareto diagram, the categories are arranged in order of decreasing frequency. This diagram was created using *the Bar, Pareto, and Line Charts Solver of OM Explorer*.

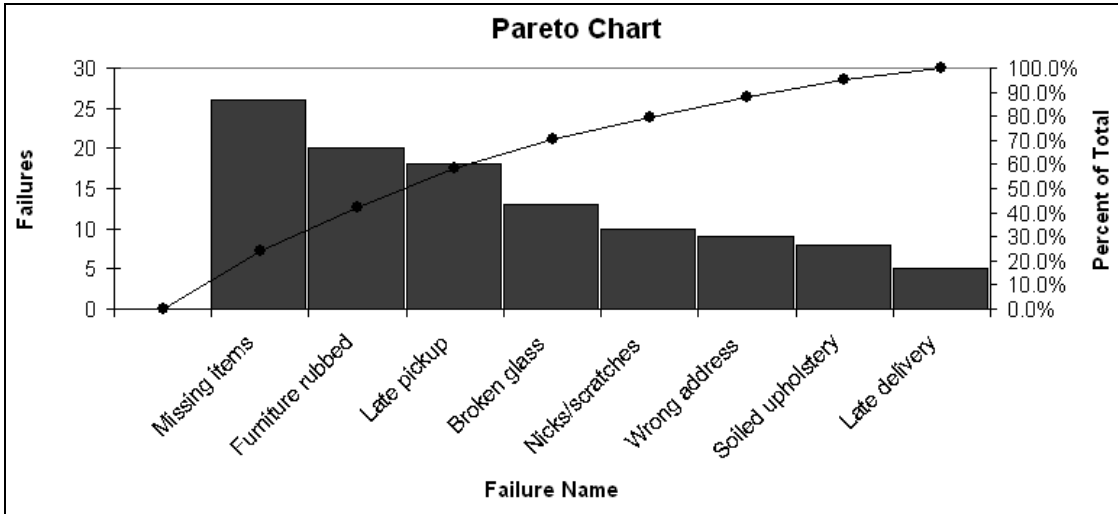

b. Cause-and-effect diagram

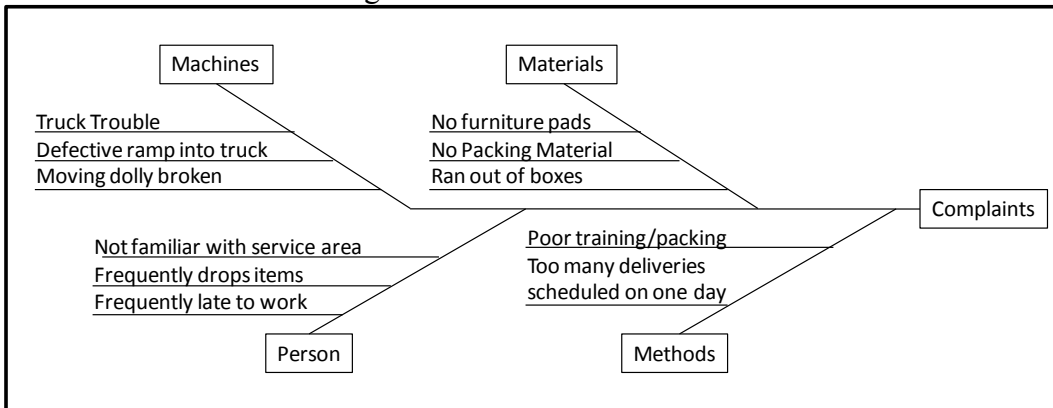

25. Golden Valley Bank

- a. Bar chart, from *the Bar, Pareto, and Line Charts Solver of OM Explorer*.

$$\text{average} = \frac{(8 \times 8) + (19 \times 11) + (28 \times 14) + (10 \times 17) + (25 \times 20) + (4 \times 23) + (10 \times 26)}{104}$$

$$= 16.2 \text{ hours}$$

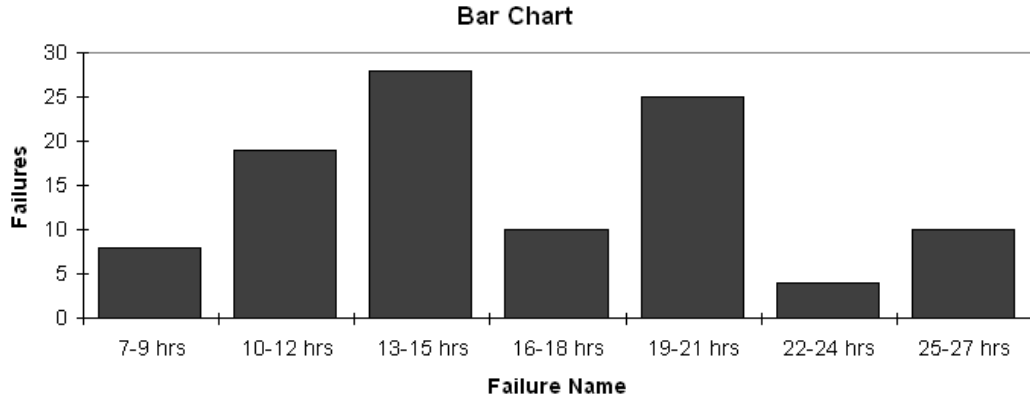

- b. Golden Valley’s average time is 16.2 hours or about two business days. However, 39 of 104 customers waited longer than 18 “business hours.” DeNeeffe should first investigate the 14 applications that required more than 22 hours to find causes of long delays.

26. East Woods Ford

- a. Bar chart, from *the Bar, Pareto, and Line Charts Solver of OM Explorer*.

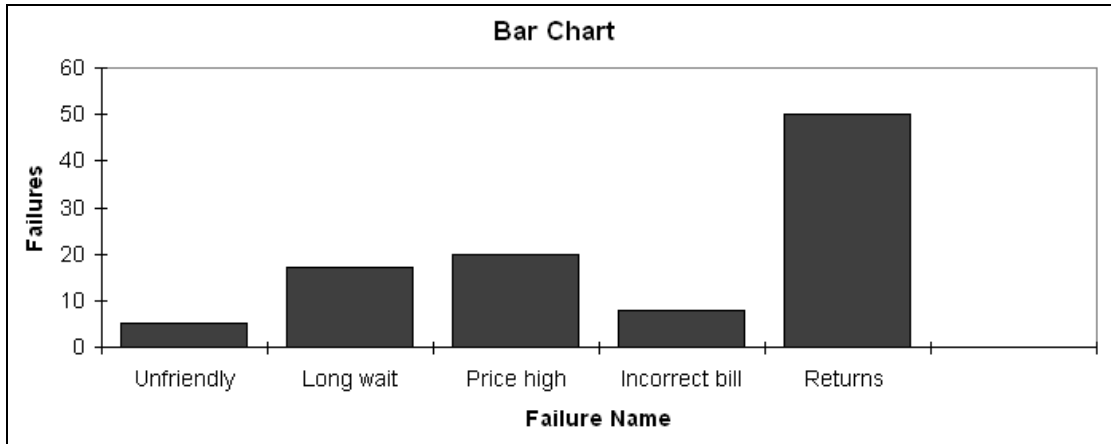

Pareto chart, from *the Bar, Pareto, and Line Charts Solver of OM Explorer*..

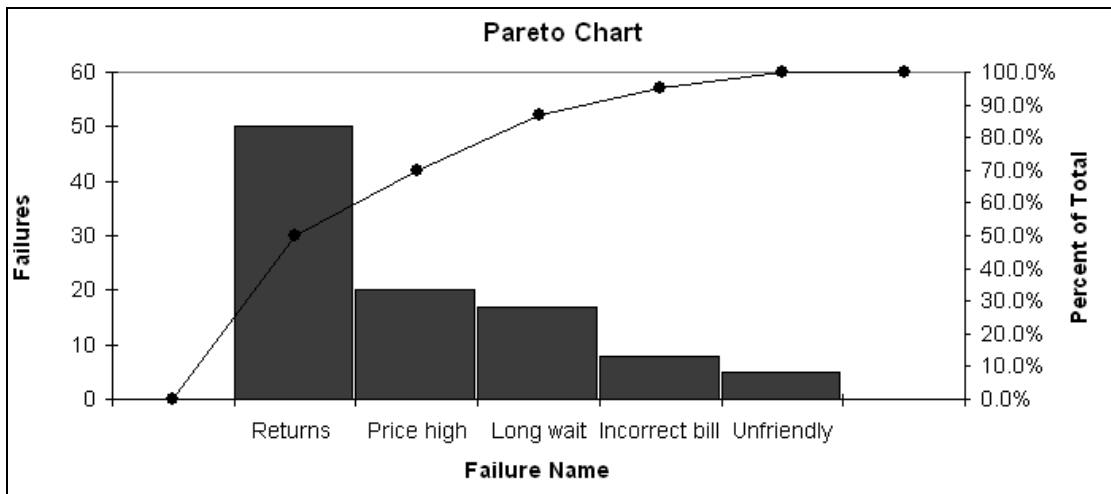

b. Cause-and-effect diagram drawn using PowerPoint.

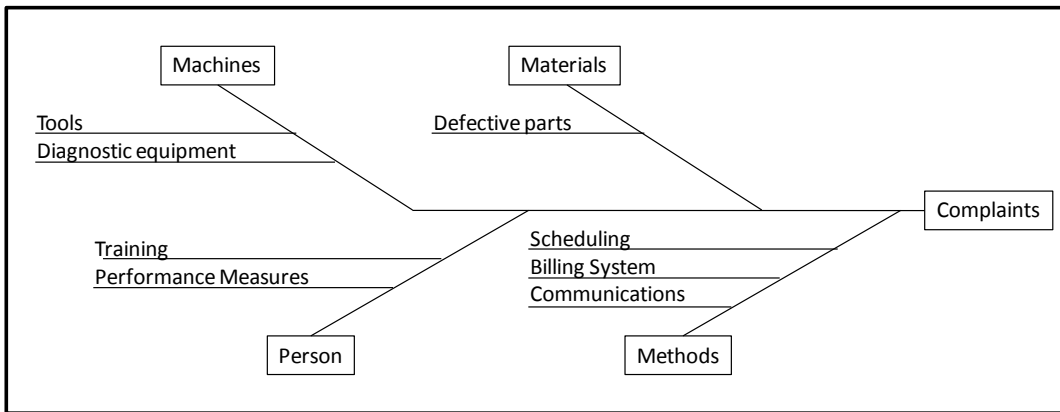

27. Oregon Fiber Board

- a. Scatter diagram (see following)
- b. As the production run size increases, the percent of failures decreases. Should schedule large runs when possible and determine what causes smaller runs to be problematic, e.g., changeover issues.

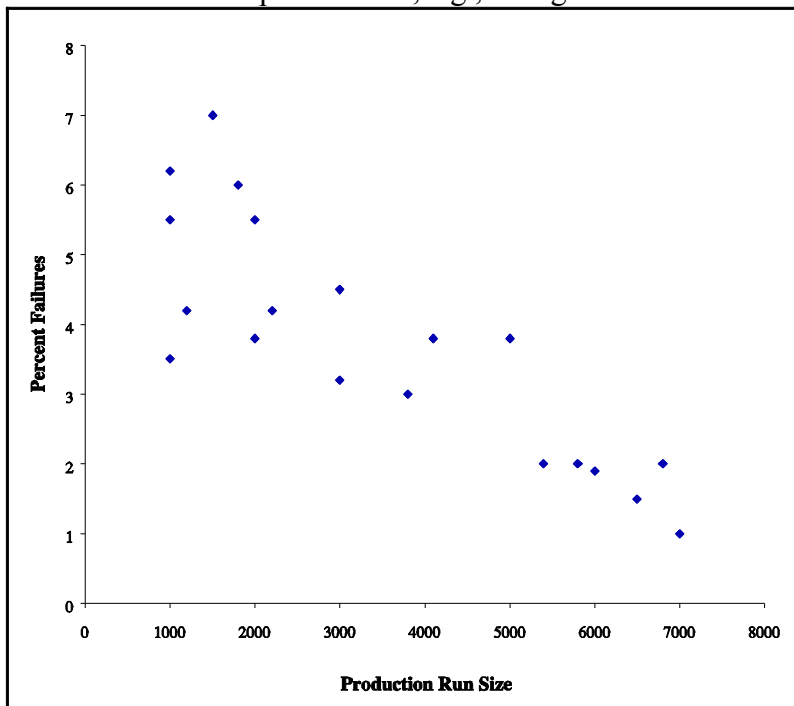

28. Grindwell, Inc.

- a. Scatter diagram

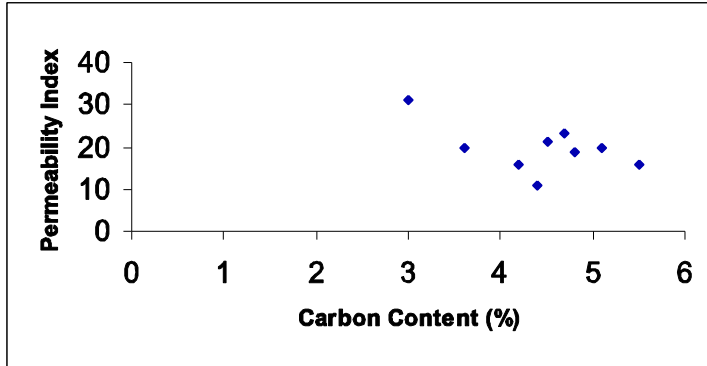

- b. Correlation coefficient  $\rho = -0.547$ . There is a negative relationship between permeability and carbon content, although it is not too strong.
- c. Carbon content must be increased to reduce permeability index.

29. Superfast Airlines. One of many possible cause-and-effect diagrams follows.

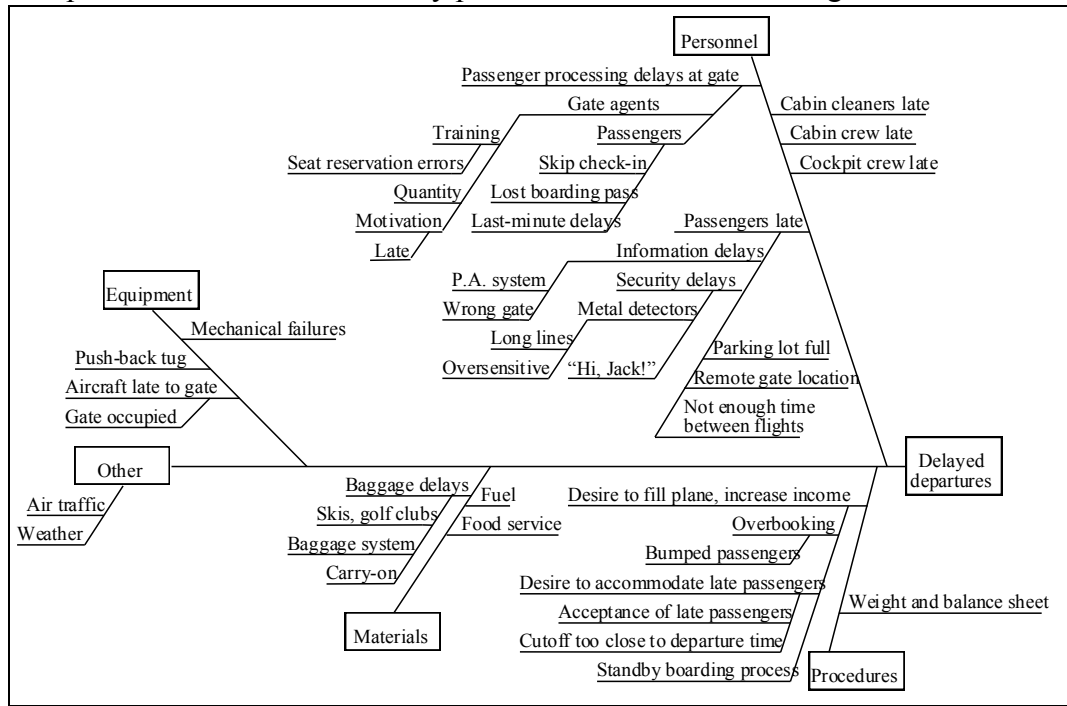

30. Plastomer, Inc.

Type of Failure	Amount of Scrap (lb)	Percent of Total Amount
1. Air bubbles	500	0.7%
2. Bubble breaks	19,650	29.3%
3. Carbon content	150	0.2%
4. Unevenness	3,810	5.7%
5. Gauge/Thickness	27,600	41.1%
6. Opacity	450	0.7%
7. Scratches	3,840	5.7%
8. Trim	500	0.7%
9 Wrinkles	10,650	15.9%
Totals	67,150	100.0%

The following Pareto chart was created using *the Bar, Pareto, and Line Charts Solver of OM Explorer*.

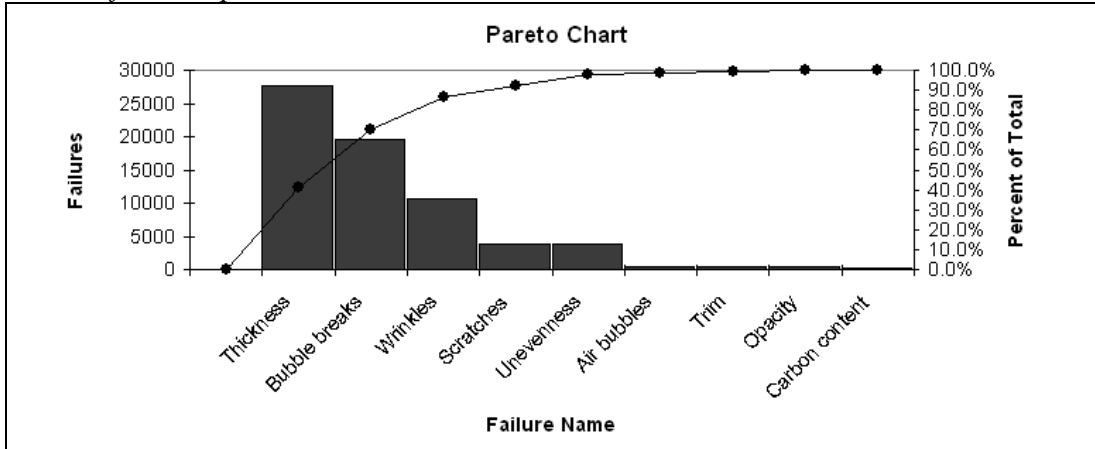

Management should attempt to improve the “thickness/gauge” problem first.

31. Shampoo bottling company

a. The tally of data into cells will be as follows.

Cell Number	Cell Boundaries	Tally	Frequency
1	12.65 up to 12.85		4
2	12.85 up to 13.05		8
3	13.05 up to 13.25		9
4	13.25 up to 13.45		9
5	13.45 up to 13.65		11
6	13.65 up to 13.85		12
7	13.85 up to 14.05		16
8	14.05 up to 14.25		11
9	14.25 up to 14.45		10
10	14.45 up to 14.65		8
11	14.65 up to 14.85		2

b. 4% of the bottles filled by the machine will be out of specification; 4% are below the lower limit, and none are above the upper limit. NOTE: If you turn the table 90 degrees counterclockwise, the tallies create a histogram.

32. Team exercise on shaving

a. One possible solution would look like this:

**Process:** Shaving  
**Subject:** Man  
**Beginning:** Remove tools  
**Ending:** Clear area

Summary

Activity	Number of Steps	Time (min)	Distance (ft)
Operation ●	4	6.20	
Transport ➡	4	0.50	20
Inspect ■	1	0.50	
Delay ◐	9	9.00	
Store ▼	--	0.00	

- Insert Step
- Append Step
- Remove Step

Step No.	Time (min)	Distance (ft)	●	➡	■	◐	▼	Step Description
1	0.10	5		X				Remove shaving bowl and soap from cabinet
2	0.10	5		X				Remove brush from cabinet
3	0.10					X		Turn warm water faucet on
4	3.00					X		Hold hand under faucet until water is warm
5	1.00					X		Create shaving lather with brush & warm water
6	1.00		X					Apply shaving lather to face
7	0.10					X		Plug sink
8	3.00					X		Turn faucet off when sink is half full
9	0.10	5		X				Remove razor from cabinet
10	0.50					X		Insert new razor blade
11	0.10		X					Draw blade across face
12	0.10					X		Rinse blade in sink
13	5.00		X					Repeat steps 11-12 until face clear of stubble
14	0.50				X			Inspect face
15	0.20					X		Thoroughly rinse razor
16	0.10		X					Dry face with towel
17	0.20	5		X				Return tools to cabinet
18	1.00					X		Unplug sink, drain completely, and clear area

Additional comments (students may have slightly different observations): After Step 2, he “walks back to sink”; Steps 3-4 and 7 & 8 are operations; The Delay step between 7 & 8 is “Wait for sink to half fill”; Between Steps 8 & 9 he “walks over to cabinet” to remove the razor (unless he gets it at Step 1 or 2) and he needs to “walk back to sink” to unplug and clean.



b. Some ideas generated from brainstorming the process:

- |  |  |
|--|--|
| 1. Leave bowl, soap, razor, and brush on the counter.            | 9. Use disposable razor or electric razor.                       |
| 2. Turn water on first.  | 10. Replace razor every other day.                               |
| 3. Buy new water heater so water warms faster.                   | 11. Grow a mustache, beard, or goatee to reduce shaving time.    |
| 4. Use shaving cream or gel.                                     | 12. Go to a barber.  |
| 5. Shave in the shower.  | 13. Let face air dry.  |
| 6. Plug sink before turning water on.                            | 14. Use cold water.  |
| 7. Run water while shaving instead of plugging and filling sink. | 15. Do not inspect the face but shave accurately the first time. |
| 8. Fill sink one-fourth full instead of half full.               | 16. Shave every other day.                                       |
|  | 17. Don't rinse blade each time.                                 |

33. Conner Company

a. Tally sheet

Type of Failure	Tally	Number of Rejected Boards
A. Poor electrolyte coverage		12
B. Lamination problems		6
C. Low copper plating		26
D. Plating separation		4
E. Etching problems		2
Total	50	50

b. Pareto chart, from OM Explorer.

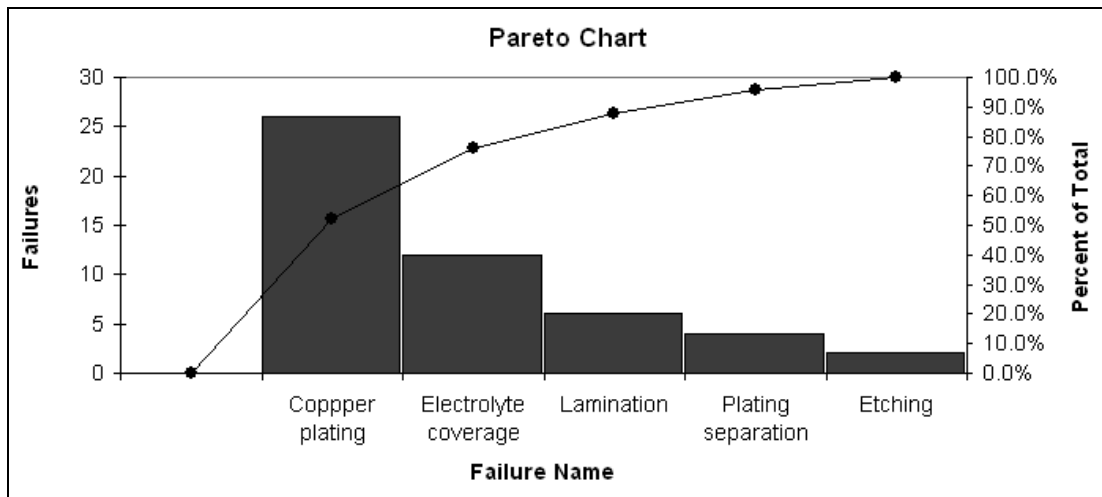

- c. Cause-and-effect diagram (Note: several alternative ideas are possible here.)

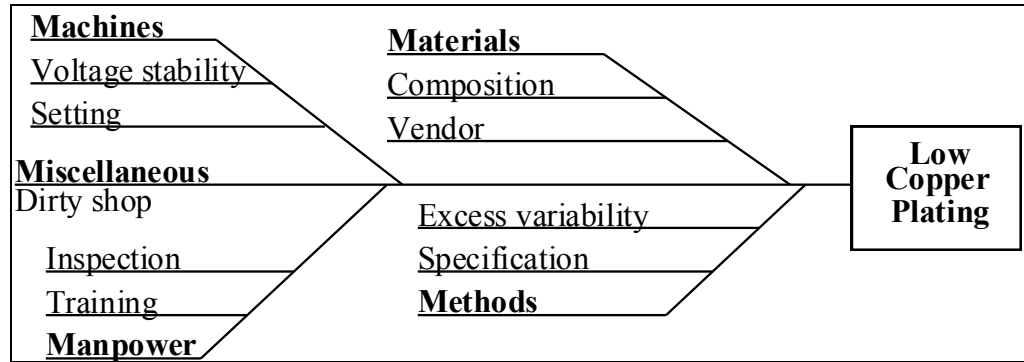

## CASE : CUSTOM MOLDS, INC. \*

### A. Synopsis

Custom Molds, Inc. is a small fabricator of custom-designed molds that are used in injection molding machines to make plastic parts. Its major customers are in the electronics industry where large volumes of plastic connectors are used. The company has recently noticed a shift in its market as the total demand for molds has declined, but the requests for molded parts have increased. In response to this shift, Custom Molds, Inc. has expanded its operations to include the manufacture of plastic parts. The case provides students with the opportunity to analyze the different processes associated with mold fabrication and parts production and to discuss the interaction between process management decisions and competitive priorities.

### B. Purpose

The purpose of this case is to focus the student on issues relating to process strategy and to discuss how decisions involving process structure, customer involvement, resource flexibility, and capital intensity interact with different competitive priorities. Students need to resolve what it will take to compete effectively in each of Custom Molds' markets and how best to configure its processes. One needs to consider specific issues:

1. There are two distinctly different processes taking place in the same facility. The students should diagram each process (see flowcharts in Chapter 4) and compare/contrast the strengths and weaknesses of each.

\* This case was prepared by Dr. Brooke Saladin, Wake Forest University, as a basis for classroom discussion.

2. The different processes serve different customer needs. Mold fabrication requires flexibility and quality where parts manufacturing competes on delivery and low cost. The margin for parts is much smaller.
3. Although the number of orders has remained relatively stable, the volume per order for **parts** has increased significantly over the last three years. This increase has caused bottlenecks in the shop and has led to late deliveries of parts.
4. The change in sales mix has created excess capacity in mold fabrication, and the owner has relegated one of the master machinists to the role of expeditor.

### C. Analysis

Students should begin their analysis by examining the market trend data in the two tables in the case. These data clearly show that although the number of orders received over the three-year period for molds has remained constant, the total number of molds fabricated has shown a declining trend: 722 in 2006, 684 in 2007, and 591 in 2008. With 13 master machinists employed, mold fabrication capacity can be estimated at

$$13 \text{ machinists} \times 250 \text{ days/year} \div 5 \text{ days/mold}$$

or 650 molds fabricated/year

Another way to look at the excess capacity question is that each master machinist working 250 days per year, averaging five days' processing time per mold fabricated, can produce 50 molds per year. At a current demand rate of 591, only 12 master machinists are required.

As an aside, note that the regular-time capacity of 650 molds per year was actually insufficient to handle the demand in 2006 and 2007. Presumably overtime was used in these earlier years to make up the shortfall, although not stated in the case. At this point the changing sales mix not only alleviated any earlier capacity shortage, but created enough excess capacity now that Tom Miller reassigned one of the master machinists to an expediting function.

Parts manufacturing, however, shows the opposite trend. The number of orders has actually declined a bit but the total of parts processed has risen drastically over three years: 47,200 in 2006, 67,150 in 2007, and 114,850 in 2008. Although data are not provided on the processing times of individual parts, we can see that the order sizes are getting much larger. This trend has most likely caused bottlenecks at the injection molding operation, because the operations both before and after the injection machine take only one or two days to complete. Therefore, the late deliveries that customers are complaining about are probably due to molds being delayed or orders waiting for the injection machines. Delays and time pressures may also be contributing to quality problems as operators hurry to process orders.

The analysis should then determine the process flow in diagrams of each step. This will enable students to see where time and resources are being consumed. These flows can be compared to the layout block plan in Figure 3.18 to get an idea of the material flows in the plant.

In the final phase of the analysis, students should discuss the strengths and weaknesses of each process and relate these to the different competitive priorities needed to compete in each market.

<b>Mold Fabrication</b>	<b>Parts Manufacturing</b>
Job process	Line process
High customer contact	Less-skilled labor
High-skilled labor	More capital intensive
Divergent processes	Less-divergent process

The mold fabrication market requires a great deal of flexibility in order to design and custom-make molds to meet customer requirements. Quality is also very important in meeting demanding specifications. Short delivery times are less critical, as the design phase, working closely with the customer, can be lengthy. Costs are also a secondary consideration, as the cost of the mold is typically a minor component of the customer's overall cost of manufacturing.

Custom Molds, Inc. has expanded into the manufacturing of plastic parts. Parts manufacturing is a higher-volume, cost-sensitive market. Parts are needed in a timely manner to keep customer production processes running. Volume flexibility becomes more important than product flexibility. So students should be able to see that the company has exposed itself to a different set of competitive priorities.

#### **D. Recommendations**

At this stage, early in an operations management course, specific recommendations will be difficult for students and should not be the primary focus. The instructor should look for general recommendations concerning: (1) capacity decisions and the allocation of production resources; (2) the possible orientation toward either molds fabrication or parts manufacturing; and (3) the physical separation and focusing of each distinct process. A sample student response to the discussion questions that follow will give (Exhibit TN.1) some idea of what to expect from a student in an introductory course in operations and supply chain management course.

#### **E. Teaching Strategy**

This case is designed to be used early in the course. A primary focus is to expose the students to the concept of flowcharting processes (covered more fully in Chapter 4) and using the flowcharts to analyze the strengths and weaknesses of the processes. A second focus is to show the students the impact that process choice decisions have on the ability of the company to compete on different competitive priorities.

For best results the instructor should assign this case as a homework assignment. Students should come to class prepared to share their process flow diagrams. The discussion then can pretty much follow the discussion questions at the end of the case.

First make sure the students realize the company faces capacity issues brought about by the expansion into parts manufacturing. Then move to the analysis of the flowcharts. As students begin to see the strengths and limitations of each process, you can then move on to a discussion of the interaction between market-required competitive priorities and differing process characteristics.

This case can easily take a full 50- or 75-five-minute class if students share their flowcharts and the instructor has the class as a group develop the two flowcharts on

the board. This, however, is a good exercise for students to be involved in, as they learn that flowcharts for even seemingly simple processes may be more difficult to develop than they thought.

**EXHIBIT TN.1****Custom Molds, Inc. Student Responses*****Question 1***

The Millers face a changing market environment for their two product lines—molds and plastic parts—a problem that they must address. The mold market is in the mature phase. Though the number of mold orders is constant, the average number of molds per orders is decreasing. This information may imply that customers are letting Custom Molds prototype the mold design, but they are then fabricating the molds in-house once they validate the design. The plastic parts market is in a growth phase, at least from the Millers' perspective. The plastic parts market shows a sizable increase in average order size. This market shift is causing the Millers' problems on the shop floor as the company shifts from mold production to plastic parts production.

***Question 2***

The market shift from molds to plastic parts impacts Custom Molds because of the different production process required for each product. Mold production is a job process environment with only a limited number of molds manufactured per order. This process requires highly trained and skilled workers to manufacture the molds. Plastic parts production is primarily a batch process, with characteristics of a line process, which produces small runs of similar products. Unlike mold production, the skill level of the labor is not as high. However, both products are made to order, so there are similarities between the two, especially in terms of production scheduling.

Quality, product design, and flexibility are important competitive priorities for the molds. Price and delivery are competitive factors but only as order qualifiers, not order winners. For the plastic parts, delivery and price are more important; quality and flexibility become order qualifiers. The importance of maintaining the delivery schedule has caused many of the problems with Custom Molds production.

Both production processes at Custom Molds have a great deal of slack time. For example, the company schedules two to four weeks for fabrication of molds although it takes only three to five days to make the mold. For molds, these delays are not a major factor. For plastic parts, production time for 500 parts is four days' mixing, molding, trimming, inspecting, packing, and shipping. With assembly, the parts require an additional three days. Generally the company waits one week for the compounds to arrive and one week lead time before producing the molds. This provides a tight schedule for the company to meet the three-week lead time for plastic parts order promising.

***Question 3***

Alternatives for the Millers are as follows:

1. They can shift their focus to plastic parts production. This will require increasing the space dedicated to plastic parts production or adding additional space. This will also require a move away from the expediting mentality. The use of skilled machinists to expedite parts is a waste of resources. It is likely that the delays are due to a combination of expedited orders that slow regular orders and limited capacity. This choice will require commitment to expand resources and maintain delivery reliability. In addition, the company will need to recognize the increased importance of price competition.
2. They can move back to the focus on molds. However, this requires moving against the apparent trend in the industry. This strategy will require Custom Molds to take business

away from competitors in order to grow the business. Price competition may become the primary factor in industry competition. However, it is unlikely they can profitably increase their business if they follow this strategy.

## CASE: JOSE'S AUTHENTIC MEXICAN RESTAURANT \*

### A. Synopsis

Jose's Authentic Mexican Restaurant is a small, independently owned local restaurant. Ivan, the waiter, has noticed a significant reduction in the size of tips, leading him to concerns about the quality of the food and service. The characteristics of the restaurant and the process that takes place in the restaurant are described following. Students are asked to think of the characteristics of this environment that define quality to the various players, identify the implied costs of quality, and apply some of the analysis tools provided in the text.

### B. Purpose

This case provides a scenario to which students can relate. Nearly every student has eaten at a small ethnic restaurant, and you can count on their collective experience to flesh out the unspoken issues presented in the case. There is sufficient description of the process to spark considerable discussion as to how the nature of the process (and the internal customer chain) interacts with the external customer's perception of quality. The students need to develop definitions and measures of quality from several perspectives and then think of how to integrate these different views. A discussion of the restaurant's management has been purposefully excluded from this case so that the students can freely devise the interventions that should be taken to improve quality at Jose's.

### C. Discussion

1. The first question, asking how quality is defined, is designed to get students to think of defining quality from the perspective of the various players. At a minimum, the students should be able to describe the external customers as the patrons (diners) and the internal customer chain as the cook and wait staff. Other expansions may be offered as well (hostess, management, busboys, other kitchen staff, suppliers, community, etc.). A partial list of factors is presented below. No doubt, your students will come up with many more characteristics that can be used to define quality.
  - A. To the external customers (the diners), quality is defined by their expectations. The case does not explicitly describe all of the following but much may be inferred by the students based on their experiences with restaurants. The customers can expect any or all of the following:
    1. Location and access (to be in a reasonably safe, aesthetically acceptable location, to be within walking distance, have adequate parking, be served by public or other transportation).
    2. Ambiance. The appearance of the facility should fit its place and purpose.
    3. Appropriate recognition on arrival (greeted by the hostess, apprised of any wait, seated in an acceptable location).
    4. Pleasant and attentive interaction with the wait staff (a greeting shortly after being seated, orders taken when *they* are ready, well-paced delivery of food

---

\* This case was prepared by Dr. Larry Meile, Boston College, as a basis for classroom discussion.

items, periodic checks for additional needs, the bill presented when *they* are ready). Of course, determining the specific desires of each party is a particular challenge that must be met by the waiter. Do they want to speedily complete the meal and be on their way? Or, do they prefer a leisurely paced repast? Is the party in the mood for some light banter from the waiter or do they prefer to be left alone? This may be the quality characteristic over which Ivan has the most control.

5. Good-tasting food served in an appealing fashion (taste, temperature, portion, presentation). This characteristic, if held constant, is probably most important for first-time patrons. Repeat patrons already know what they are in for.
  6. Conformance to regulatory agency guidelines. If the restaurant is open, it is assumed that it has been inspected and passed by the appropriate regulatory agencies.
  7. Value. The combination of all the preceding when price is factored in.
- B. To the cook, an internal customer, quality is largely related to the work environment.
1. The raw materials are available when needed, are fresh and tasty, have good appearance, are easy to prepare (perhaps even have some of the nasty tasks already completed—like prepeeled potatoes), and are consistent from purchase to purchase.
  2. The equipment is properly suited for the task, performs reliably (e.g., the oven is always at 350° when the dial is set to 350), is easy to use, and is laid out effectively.
  3. The environment is satisfactory; it is well lit and temperature controlled, coworkers and management offer respect, work load is reasonably level (ideally there is no mealtime rush to contend with), working hours are acceptable, wages and benefits are competitive, salary is paid on time.
- C. To Ivan (also an internal customer), quality also relates to the workplace environment.
1. The quality of the finished goods (the meals). The meal is the one described in the menu, it is of adequate portion, it is produced in a timely fashion, it tastes good, and it has a pleasant appearance.
  2. The serving equipment is appropriate, functional, and clean. The dishes, cups, glasses, tableware are clean and appropriate for the purpose. The tablecloth and seating area are clean and orderly. The waitstation has the appropriate equipment (coffeemaker, ice and water dispenser, etc.)
  3. The environment provides a place in which it is pleasant to work (many of the same issues as the cook, listed earlier).
- D. To the restaurant's management, quality is primarily related to the firm's image (in addition to the personal working environment issues faced by all employees).
1. The restaurant's reputation in the community: viewed as an asset to the community, a community supporter, a source of gainful employment, a nonpolluter, a good neighbor.
  2. The restaurant's image in the eye of the consumer (diner): all of the customer's quality issues mentioned previously are met.



3. The restaurant's image with governmental agencies: the health department finds little fault with its operation, fire codes are met, appropriate security measures have been taken, taxes are paid in full and on time.

Quality definitions can also be discussed by category:

- Customer-driven definitions of quality
  - Conformance to specifications—food (weight, appearance, congruent with menu description), preparation time, meeting health regulations.
  - Value—customers feel that the food, service, and ambiance are worth the price.
  - Fitness for use—customers leave feeling well fed. Dietary concerns are met (low fat, low sodium, etc. where appropriate)
  - Support (recovery from failure)—if something is not satisfactory, how is it rectified (issue recognized, apology offered, items quickly replaced, substitutes offered, bill adjusted, etc.)?
  - Psychological impressions—the feeling the diner gets based on the atmosphere of the restaurant, the interactions with the staff, and the characteristics of the food.
2. Question two asks the students to list some of the costs of poor quality. Although specific values cannot be placed on them, conceptual sources of costs can be identified. Note that these can be viewed from the restaurant's perspective and from Ivan's perspective, and by shifting the view, the interventions (and costs) change. A short list of possible actions and costs is provided following:

A. Prevention:

- Restaurant: Purchase better food stock (dollars). Reject and reorder sub par supplies (time)  
Set (and meet) food preparation standards (time)
- Ivan: Cull out poorly prepared meals; ask for replacements (time)

B. Appraisal:

- Restaurant: Inspect incoming food stock (time)  
Survey
- Ivan: Inspect meals prepared by the cook (time)

C. Internal failure:

- Restaurant: Replace (or rework) rejected meals (time, dollars)
- Ivan: Help the cook get an order out faster (time)

D. External failure:

- Restaurant: Unsatisfactory customer experience (dollars)
- Ivan: Poor-quality meal to be served to customer (dollars)

3. Four of the quality tools are appropriate for Question Three. Checklists are already done. Results of the customer satisfaction survey are shown in the case. From this list a histogram or bar chart of the customer complaints can be made (see Exhibit TN.1) and a Pareto chart ranking them in importance can be constructed (see Exhibit TN.2).

It may be useful to ask the students if the survey results include all Jose's customers. The concept of nonresponse bias can be brought forth. Maybe long-time satisfied customers figure if nothing is wrong, no reply is needed. Maybe disgusted customers are so put out that they don't even want to take the time to help rectify the situation. They will simply vote with their feet and not return. Also note that the data collected clusters the results from both first-time and returning customers. Point out to the students that a great deal of information may be lost by not reporting these results separately.

Also ask the students about what information was *not* captured when a negative response was given to any of the customer survey questions. If they were not seated promptly, how long did they wait? If the waiter was not satisfactory, what was lacking? If the food was not enjoyable, what was the problem? Finally, if the dining experience was not worth the cost, what needs to be changed?

A cause-and-effect (fishbone) diagram (see Exhibit TN.3) can be constructed from the results of the survey, the information given in the text of the case, and some assumptions about the behavior of the restaurant (as suggested by the students from their dining experiences).

#### **D. Recommendations**

Although no specific recommendations are called for, the students should be pressed to think of what Ivan can do to improve his situation. The concept of employee involvement (one of the elements of the TQM Wheel) can be discussed here. This case provides a reverse view of the material discussed in the chapter. The chapter talks of management's challenge in establishing appropriate cultural change (including awareness of the voice of the customer, advocating the concept of an internal customer chain, and quality at the source), promoting individual development, and creating effective awards and incentives. All of these issues can be viewed from Ivan's perspective and point out the frustrations experienced by employees if good quality management is not practiced.

#### **E. Teaching Suggestions**

It is effective to ask the students to read this case before the discussion of the material in the chapter. The case then can act as a common situation that can be used when lecturing on the various quality topics. As the topics addressed by the questions at the end of the case are covered by lecture, the students can be asked to respond to them as part of the classroom discussion.

If the case is used after the chapter material has been covered, it can be used as a cold-call case or it can be assigned for preparation before discussion in class. If prior preparation is done, it may be effective to have the students answer the questions by themselves and then meet as small groups to consolidate their ideas.

When discussing the costs of poor quality, it may be useful to provide a table for the students on the board or on an overhead transparency listing the four costs and providing two columns, one for the restaurant and one for Ivan as follows:

	<b>Restaurant</b>	<b>Ivan</b>
Prevention		
Appraisal		
Internal failure		
External failure		

*Possible points for discussion* (those points in italics are covered in the preceding discussion):

*Customer-driven definitions of quality*

*Conformance to specifications*

*Value*

*Fitness for use*

*Support (recovery from failure)*

*Psychological Impressions*

Quality as a competitive weapon

Employee involvement

Customer definition

External

Internal

Continuous improvement

Plan-do-act-check cycle

*Costs of poor quality*

*Prevention*

*Appraisal*

*Internal failure*

*External failure*

Improvement through TQM

Benchmarking (Not done within the case but the concept could be discussed.)

Product/service design

Reliability

*Tools for improving quality*

*Checklists (customer satisfaction survey)*

*Histograms/bar charts*

*Pareto charts*

*Cause-and-effect (fishbone) diagram*

**EXHIBIT TN.1** A Bar Chart of the Customer Complaints from the Customer Satisfaction Survey Shown in the Case

Were you seated promptly?	Yes	70	No	13
Was your waiter satisfactory?	Yes	73	No	10
Were you served in a reasonable time?	Yes	58	No	25
Was your food enjoyable?	Yes	72	No	11
Was your dining experience worth the cost?	Yes	67	No	16

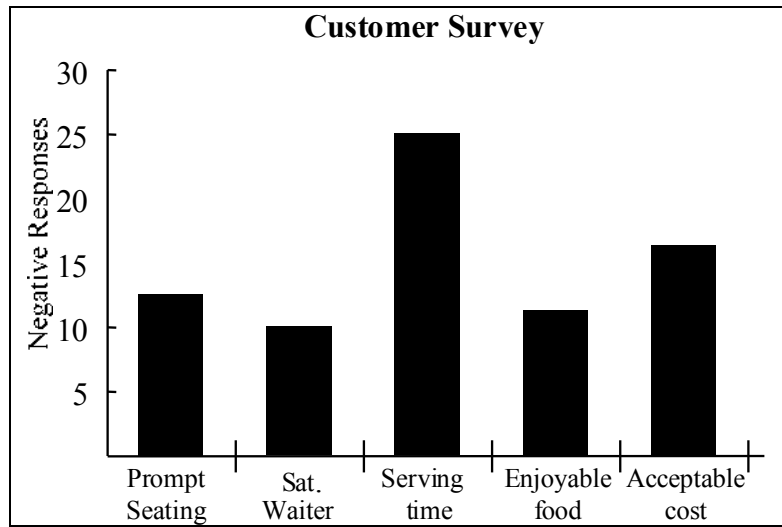

**EXHIBIT TN.2** A Pareto Chart Ranking Customer Complaints

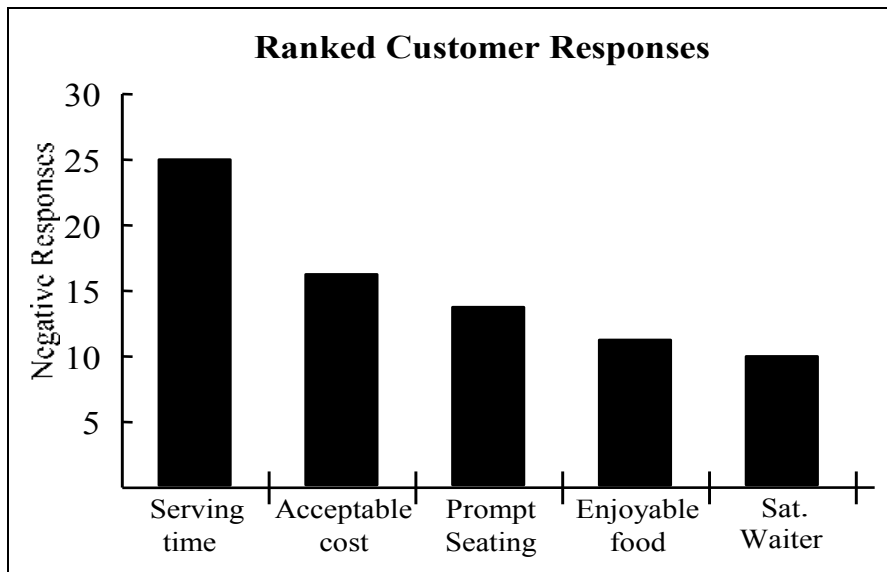

**EXHIBIT TN.3** A Possible Cause-and-Effect (Fishbone) Diagram

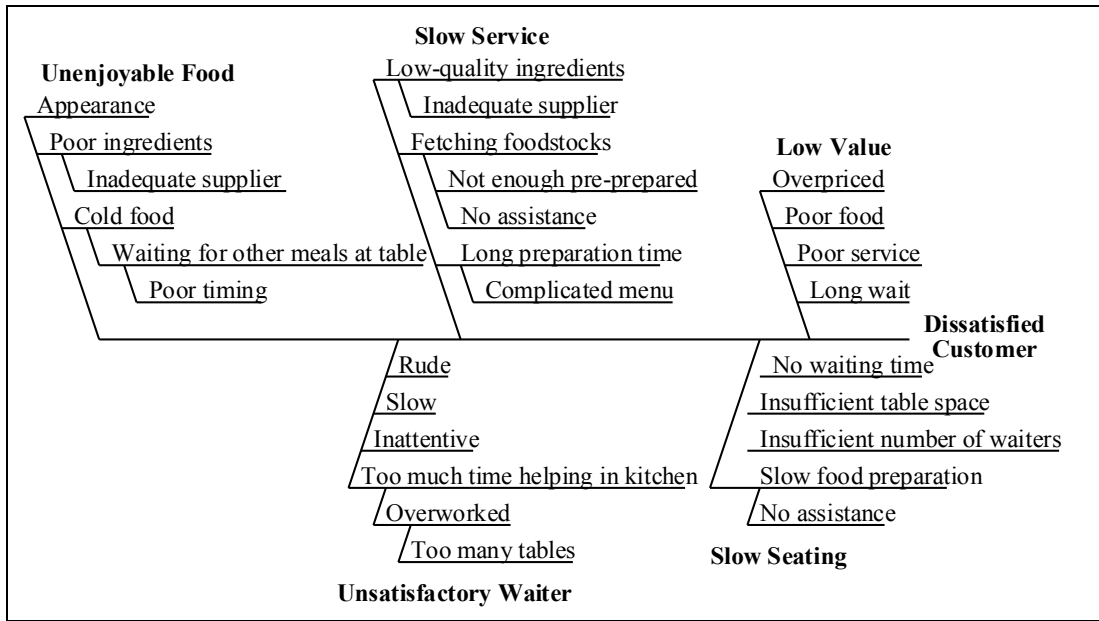

**Alternate survey:**

1 = Completely Satisfied; 5 = Extremely Dissatisfied

How satisfied were you with	Customer survey results (Number of replies to each response option)				
	1	2	3	4	5
Promptness of seating	129	63	19	14	9
Service of your waiter	134	56	31	0	14
Speed of service	110	45	40	9	31
Enjoyability of food	122	52	31	16	14
Price of dinner	129	71	19	2	14

## ADDITIONAL CASE IN myomlab

### CASE: THE FACILITIES MAINTENANCE PROBLEM AT MIDWEST UNIVERSITY \*

#### A. Synopsis

This case describes the problems facing a medium-sized university, Midwest University, as it tries to maintain 60 buildings on campus. The specific problem is slow response time in completing work-order requests. The facilities maintenance area is organized, structured, and scheduled around skilled craft areas. The issue facing Sean Allen, manager of the facilities area, is how to organize and manage his personnel to reduce this poor response time.

#### B. Purpose

The focus of this case is to highlight the importance that job design plays in the delivery of a quality service package. As it now stands, the facilities maintenance area at Midwest University is organized around craft functions, in much the same way most traditional organizations are organized around finance, marketing, and operations. The problem is that the processes necessary to provide a quality service require coordination and integration across the skilled crafts. This leads to the necessity of redesigning the way work is to be completed. The issues of job design brought out in the case include:

1. Movement from a vertical organizational structure to a multicraft team-oriented, horizontal organization
2. Use of enlargement, rotation, and enrichment as jobs are redesigned
3. Training requirements necessary to support the new job designs
4. Measuring the performance of the new organizational structure and providing appropriate recognition

#### C. Analysis

The analysis and class discussion should begin by focusing on the issue of why facilities maintenance is providing such poor response times to work-order requests. Students who have ever lived on campus will readily identify with this problem. Five- to ten-day lead times for work requests that, for the most part, take less than one hour do seem a little absurd. The analysis of the problem should focus on the key factors that contribute to this poor performance. Students should quickly be able to identify the following three factors:

1. The difficulty in prioritizing work-order requests across both crafts and buildings for scheduling purposes
2. The frequent need to involve more than one craft in order to complete the work-order request

---

\* This case was prepared by Dr. Brooke Saladin, Wake Forest University, as a basis for classroom discussion.

3. The geographical dispersion of 60 different buildings that need to be maintained  
As the problem-identification discussion continues, students may add other factors to these three. The instructor's job here is to bring the students to the realization that the top-down scheduling of work-order requests across crafts and 60 different buildings is a very complex and integrative process. Students should begin to realize that poor lead-time performance is actually a symptom of a much larger problem, that is, the conflicts that are present by having a "functional silo" orientation to job design when the performance of the job to meet customer requirements calls for a multidisciplinary team approach. The rest of the analysis should focus on the seven key elements of job design for horizontal organizations:
  1. *Organize around processes*: Ask students to identify the core processes that are critical to the success of the facilities maintenance area. Key processes identified should include:
    - ❑ Order receipt and processing
    - ❑ Work scheduling and dispatching
    - ❑ Physical maintenance and repair
  2. *Flatten the organizational hierarchy*: Supervision can be reduced by breaking down the "functional craft silos" and the inherent managerial redundancy created by each craft managing itself.
  3. *Teams manage the organization*: Teams can be organized around the core processes identified in point #1. Another factor to consider is the geographical dispersion of the buildings on campus. Teams could be organized not only as multicraft maintenance and repair groups but also around specific geographical areas of the campus. Teams could then receive, schedule, and repair their own work requests over a designated number of buildings. This would push responsibility through the teams and help alleviate the problem of travel across campus.
  4. *Customers drive performance*: By having teams assigned to specific buildings, relationships that would enhance the teams' knowledge of customer requirements could be developed. Specific measures of customer satisfaction would need to be developed.
  5. *Management rewards team per performance*: This structure naturally leads to cross-training opportunities for which team members could be rewarded. Other measures, such as number of work requests completed per time period, average time to complete a work request, and customer satisfaction index ranking, need to be established to evaluate the performance of the team as a whole.
  6. *Supplies and customer contact*: Geographical assignments will help foster customer contact. This decentralization may, however, remove the teams from maintenance and repair suppliers.

7. *Training programs for all employees:* Training should not only include the opportunity for cross-craft skill training but should also look at communication, team building, process improvement, problem solving, and administrative skills.

#### **D. Recommendations**

The instructor should focus the students on looking at the “big picture” in making recommendations with respect to job design. Students should address the issue of moving toward a horizontal organization and away from the traditional, vertically oriented craft silos. Their recommendations should encompass each of the seven key factors of job design.

As a side note, the manager of facilities maintenance actually created cross-functional craft teams and assigned these teams to specific areas of the campus. Individual teams were responsible for scheduling and completing work within their own assigned geographical area. The custodial staff was also integrated into the team, which helped in planning and completing routine maintenance. The teams were able to become familiar with both their “customers” and the individual needs of the buildings in their area. Response times have been drastically reduced, with 50% of the requests getting same-day service and 80% of the work-order requests getting next-day service. Large requests that exceed the resources of an individual team are still coordinated by the main office.

#### **E. Teaching Strategy**

This is a short cold-call case that is positioned to get students thinking about the impact job design has on an organization’s ability to satisfy customer needs. Students should draw not only from the material on teams in Chapter 5, “Quality and Performance”, but also from the concepts in Chapter 3, “Process Strategy”.

If you like using groups, this case can be effectively discussed by breaking the class into groups and giving them 15 to 20 minutes to brainstorm alternative approaches to reducing the response time to work-order requests. Then get them back together and go around to each group for a report on what they brainstormed, putting each group’s responses on the board. Compare and contrast the similarities and differences in each group’s approach.

The instructor should take the last 10 to 15 minutes to categorize the group’s responses on the board with respect to the major concepts of the chapter. Indicate which alternatives focus on each of the seven key factors of job design; which responses deal with enlargement, rotation, or enrichment; which focus on the development of standards, training needs, or incentive plans. By doing this summary, the instructor has the opportunity to tie the concepts of job design together into an integrated whole. You can conclude by describing briefly what actually happened as presented in the recommendation section.