

SOLUTIONS MANUAL

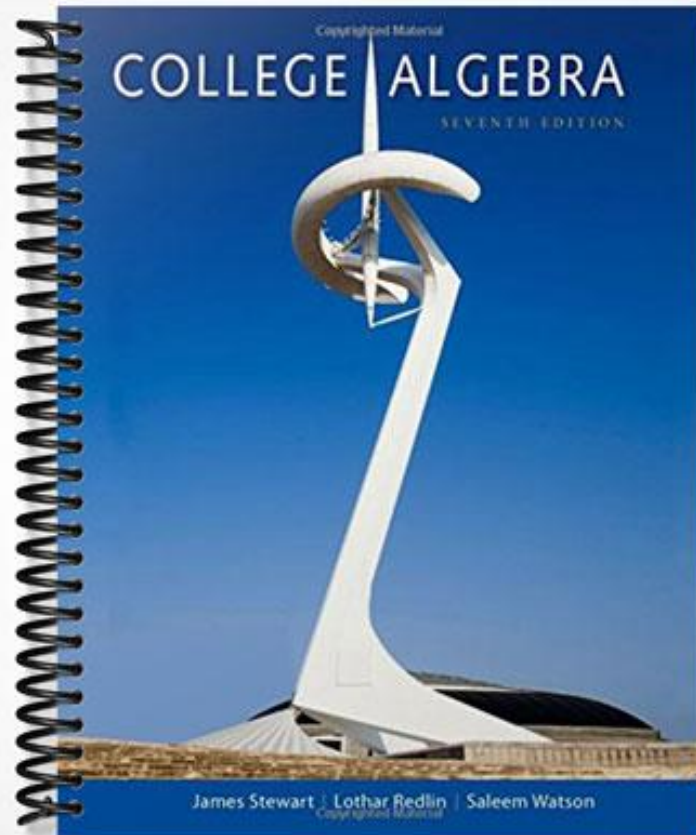

CONTENTS

■	PROLOGUE: Principles of Problem Solving	1
CHAPTER P	PREREQUISITES	3
P.1	Modeling the Real World with Algebra	3
P.2	Real Numbers	4
P.3	Integer Exponents and Scientific Notation	9
P.4	Rational Exponents and Radicals	14
P.5	Algebraic Expressions	18
P.6	Factoring	22
P.7	Rational Expressions	27
P.8	Solving Basic Equations	34
P.9	Modeling with Equations	39
	Chapter P Review	45
	Chapter P Test	51
■	FOCUS ON MODELING: Making the Best Decisions	54
CHAPTER 1	EQUATIONS AND GRAPHS	57
1.1	The Coordinate Plane	57
1.2	Graphs of Equations in Two Variables; Circles	65
1.3	Lines	79
1.4	Solving Quadratic Equations	90
1.5	Complex Numbers	98
1.6	Solving Other Types of Equations	101
1.7	Solving Inequalities	110
1.8	Solving Absolute Value Equations and Inequalities	129
1.9	Solving Equations and Inequalities Graphically	131
1.10	Modeling Variation	139
	Chapter 1 Review	143
	Chapter 1 Test	161

- **FOCUS ON MODELING:** Fitting Lines to Data 165

CHAPTER 2 **FUNCTIONS** **169**

- 2.1 Functions 169
- 2.2 Graphs of Functions 178
- 2.3 Getting Information from the Graph of a Function 190
- 2.4 Average Rate of Change of a Function 201
- 2.5 Linear Functions and Models 206
- 2.6 Transformations of Functions 212
- 2.7 Combining Functions 226
- 2.8 One-to-One Functions and Their Inverses 234
- Chapter 2 Review 243
- Chapter 2 Test 255
- **FOCUS ON MODELING:** Modeling with Functions 259

CHAPTER 3 **POLYNOMIAL AND RATIONAL FUNCTIONS** **267**

- 3.1 Quadratic Functions and Models 267
- 3.2 Polynomial Functions and Their Graphs 276
- 3.3 Dividing Polynomials 291
- 3.4 Real Zeros of Polynomials 301
- 3.5 Complex Zeros and the Fundamental Theorem of Algebra 334
- 3.6 Rational Functions 344
- Chapter 3 Review 377
- Chapter 3 Test 395
- **FOCUS ON MODELING:** Fitting Polynomial Curves to Data 398

CHAPTER 4 **EXPONENTIAL AND LOGARITHMIC FUNCTIONS** **401**

- 4.1 Exponential Functions 401
- 4.2 The Natural Exponential Function 409
- 4.3 Logarithmic Functions 414
- 4.4 Laws of Logarithms 422
- 4.5 Exponential and Logarithmic Equations 426

- 4.6 Modeling with Exponential Functions 433
- 4.7 Logarithmic Scales 438
- Chapter 4 Review 440
- Chapter 4 Test 448
- **FOCUS ON MODELING:** Fitting Exponential and Power Curves to Data 450

CHAPTER 5 **SYSTEMS OF EQUATIONS AND INEQUALITIES** **455**

- 5.1 Systems of Linear Equations in Two Variables 455
- 5.2 Systems of Linear Equations in Several Variables 462
- 5.3 Partial Fractions 470
- 5.4 Systems of Nonlinear Equations 481
- 5.5 Systems of Inequalities 488
- Chapter 5 Review 500
- Chapter 5 Test 508
- **FOCUS ON MODELING:** Linear Programming 511

CHAPTER 6 **MATRICES AND DETERMINANTS** **519**

- 6.1 Matrices and Systems of Linear Equations 519
- 6.2 The Algebra of Matrices 530
- 6.3 Inverses of Matrices and Matrix Equations 538
- 6.4 Determinants and Cramer's Rule 548
- Chapter 6 Review 562
- Chapter 6 Test 572
- **FOCUS ON MODELING:** Computer Graphics 575

CHAPTER 7 **CONIC SECTIONS** **579**

- 7.1 Parabolas 579
- 7.2 Ellipses 584
- 7.3 Hyperbolas 593
- 7.4 Shifted Conics 600
- Chapter 7 Review 612
- Chapter 7 Test 622
- **FOCUS ON MODELING:** Conics in Architecture 624

CHAPTER 8 SEQUENCES AND SERIES **627**

- 8.1** Sequences and Summation Notation 627
- 8.2** Arithmetic Sequences 632
- 8.3** Geometric Sequences 637
- 8.4** Mathematics of Finance 645
- 8.5** Mathematical Induction 649
- 8.6** The Binomial Theorem 658
- Chapter 8 Review 662
- Chapter 8 Test 669
- **FOCUS ON MODELING:** Modeling with Recursive Sequences 670

CHAPTER 9 PROBABILITY AND STATISTICS **673**

- 9.1** Counting 673
- 9.2** Probability 680
- 9.3** Binomial Probability 688
- 9.4** Expected Value 693
- Chapter 9 Review 695
- Chapter 9 Test 701
- **FOCUS ON MODELING:** The Monte Carlo Method 702

APPENDIXES **705**

- A** Calculations and Significant Figures 705
- B** Graphing with a Graphing Calculator 705

PROLOGUE: Principles of Problem Solving

- Let r be the rate of the descent. We use the formula $\text{time} = \frac{\text{distance}}{\text{rate}}$; the ascent takes $\frac{1}{15}$ h, the descent takes $\frac{1}{r}$ h, and the total trip should take $\frac{2}{30} = \frac{1}{15}$ h. Thus we have $\frac{1}{15} + \frac{1}{r} = \frac{1}{15} \Leftrightarrow \frac{1}{r} = 0$, which is impossible. So the car cannot go fast enough to average 30 mi/h for the 2-mile trip.
- Let us start with a given price P . After a discount of 40%, the price decreases to $0.6P$. After a discount of 20%, the price decreases to $0.8P$, and after another 20% discount, it becomes $0.8(0.8P) = 0.64P$. Since $0.6P < 0.64P$, a 40% discount is better.
- We continue the pattern. Three parallel cuts produce 10 pieces. Thus, each new cut produces an additional 3 pieces. Since the first cut produces 4 pieces, we get the formula $f(n) = 4 + 3(n - 1)$, $n \geq 1$. Since $f(142) = 4 + 3(141) = 427$, we see that 142 parallel cuts produce 427 pieces.
- By placing two amoebas into the vessel, we skip the first simple division which took 3 minutes. Thus when we place two amoebas into the vessel, it will take $60 - 3 = 57$ minutes for the vessel to be full of amoebas.
- The statement is false. Here is one particular counterexample:

	Player A	Player B
First half	1 hit in 99 at-bats: average = $\frac{1}{99}$	0 hit in 1 at-bat: average = $\frac{0}{1}$
Second half	1 hit in 1 at-bat: average = $\frac{1}{1}$	98 hits in 99 at-bats: average = $\frac{98}{99}$
Entire season	2 hits in 100 at-bats: average = $\frac{2}{100}$	99 hits in 100 at-bats: average = $\frac{99}{100}$

- Method 1:* After the exchanges, the volume of liquid in the pitcher and in the cup is the same as it was to begin with. Thus, any coffee in the pitcher of cream must be replacing an equal amount of cream that has ended up in the coffee cup.

Method 2: Alternatively, look at the drawing of the spoonful of coffee and cream mixture being returned to the pitcher of cream. Suppose it is possible to separate the cream and the coffee, as shown. Then you can see that the coffee going into the cream occupies the same volume as the cream that was left in the coffee.

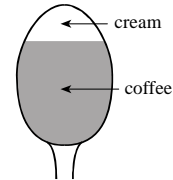

Method 3 (an algebraic approach): Suppose the cup of coffee has y spoonfuls of coffee. When one spoonful of cream is added to the coffee cup, the resulting mixture has the following ratios: $\frac{\text{cream}}{\text{mixture}} = \frac{1}{y + 1}$ and $\frac{\text{coffee}}{\text{mixture}} = \frac{y}{y + 1}$.

So, when we remove a spoonful of the mixture and put it into the pitcher of cream, we are really removing $\frac{1}{y + 1}$ of a spoonful of cream and $\frac{y}{y + 1}$ spoonful of coffee. Thus the amount of cream left in the mixture (cream in the coffee) is

$$1 - \frac{1}{y + 1} = \frac{y}{y + 1} \text{ of a spoonful. This is the same as the amount of coffee we added to the cream.}$$

- Let r be the radius of the earth in feet. Then the circumference (length of the ribbon) is $2\pi r$. When we increase the radius by 1 foot, the new radius is $r + 1$, so the new circumference is $2\pi(r + 1)$. Thus you need $2\pi(r + 1) - 2\pi r = 2\pi$ extra feet of ribbon.

8. The north pole is such a point. And there are others: Consider a point a_1 near the south pole such that the parallel passing through a_1 forms a circle C_1 with circumference exactly one mile. Any point P_1 exactly one mile north of the circle C_1 along a meridian is a point satisfying the conditions in the problem: starting at P_1 she walks one mile south to the point a_1 on the circle C_1 , then one mile east along C_1 returning to the point a_1 , then north for one mile to P_1 . That's not all. If a point a_2 (or a_3, a_4, a_5, \dots) is chosen near the south pole so that the parallel passing through it forms a circle C_2 (C_3, C_4, C_5, \dots) with a circumference of exactly $\frac{1}{2}$ mile ($\frac{1}{3}$ mi, $\frac{1}{4}$ mi, $\frac{1}{5}$ mi, \dots), then the point P_2 (P_3, P_4, P_5, \dots) one mile north of a_2 (a_3, a_4, a_5, \dots) along a meridian satisfies the conditions of the problem: she walks one mile south from P_2 (P_3, P_4, P_5, \dots) arriving at a_2 (a_3, a_4, a_5, \dots) along the circle C_2 (C_3, C_4, C_5, \dots), walks east along the circle for one mile thus traversing the circle twice (three times, four times, five times, \dots) returning to a_2 (a_3, a_4, a_5, \dots), and then walks north one mile to P_2 (P_3, P_4, P_5, \dots).

P PREREQUISITES

P.1 MODELING THE REAL WORLD WITH ALGEBRA

1. Using this model, we find that if $S = 12$, $L = 4S = 4(12) = 48$. Thus, 12 sheep have 48 legs.

2. If each gallon of gas costs \$3.50, then x gallons of gas costs \$3.5 x . Thus, $C = 3.5x$.

3. If $x = \$120$ and $T = 0.06x$, then $T = 0.06(120) = 7.2$. The sales tax is \$7.20.

4. If $x = 62,000$ and $T = 0.005x$, then $T = 0.005(62,000) = 310$. The wage tax is \$310.

5. If $v = 70$, $t = 3.5$, and $d = vt$, then $d = 70 \cdot 3.5 = 245$. The car has traveled 245 miles.

6. $V = \pi r^2 h = \pi (3^2)(5) = 45\pi \approx 141.4 \text{ in}^3$

7. (a) $M = \frac{N}{G} = \frac{240}{8} = 30$ miles/gallon

(b) $25 = \frac{175}{G} \Leftrightarrow G = \frac{175}{25} = 7$ gallons

9. (a) $V = 9.5S = 9.5(4 \text{ km}^3) = 38 \text{ km}^3$

(b) $19 \text{ km}^3 = 9.5S \Leftrightarrow S = 2 \text{ km}^3$

11. (a)

Depth (ft)	Pressure (lb/in ²)
0	$0.45(0) + 14.7 = 14.7$
10	$0.45(10) + 14.7 = 19.2$
20	$0.45(20) + 14.7 = 23.7$
30	$0.45(30) + 14.7 = 28.2$
40	$0.45(40) + 14.7 = 32.7$
50	$0.45(50) + 14.7 = 37.2$
60	$0.45(60) + 14.7 = 41.7$

12. (a)

Population	Water use (gal)
0	0
1000	$40(1000) = 40,000$
2000	$40(2000) = 80,000$
3000	$40(3000) = 120,000$
4000	$40(4000) = 160,000$
5000	$40(5000) = 200,000$

13. The number N of cents in q quarters is $N = 25q$.

14. The average A of two numbers, a and b , is $A = \frac{a+b}{2}$.

15. The cost C of purchasing x gallons of gas at \$3.50 a gallon is $C = 3.5x$.

16. The amount T of a 15% tip on a restaurant bill of x dollars is $T = 0.15x$.

17. The distance d in miles that a car travels in t hours at 60 mi/h is $d = 60t$.

8. (a) $T = 70 - 0.003h = 70 - 0.003(1500) = 65.5^\circ \text{ F}$

(b) $64 = 70 - 0.003h \Leftrightarrow 0.003h = 6 \Leftrightarrow h = 2000$ ft

10. (a) $P = 0.06s^3 = 0.06(12^3) = 103.7$ hp

(b) $7.5 = 0.06s^3 \Leftrightarrow s^3 = 125$ so $s = 5$ knots

(b) We know that $P = 30$ and we want to find d , so we solve the equation $30 = 14.7 + 0.45d \Leftrightarrow 15.3 = 0.45d \Leftrightarrow$

$d = \frac{15.3}{0.45} = 34.0$. Thus, if the pressure is 30 lb/in², the depth is 34 ft.

(b) We solve the equation $40x = 120,000 \Leftrightarrow$

$x = \frac{120,000}{40} = 3000$. Thus, the population is about 3000.

18. The speed r of a boat that travels d miles in 3 hours is $r = \frac{d}{3}$.
19. (a) $\$12 + 3(\$1) = \$12 + \$3 = \$15$
 (b) The cost C , in dollars, of a pizza with n toppings is $C = 12 + n$.
 (c) Using the model $C = 12 + n$ with $C = 16$, we get $16 = 12 + n \Leftrightarrow n = 4$. So the pizza has four toppings.
20. (a) $3(30) + 280(0.10) = 90 + 28 = \118
 (b) The cost is $\left(\frac{\text{daily}}{\text{rental}}\right) \times \left(\frac{\text{days}}{\text{rented}}\right) + \left(\frac{\text{cost}}{\text{per mile}}\right) \times \left(\frac{\text{miles}}{\text{driven}}\right)$, so $C = 30n + 0.1m$.
 (c) We have $C = 140$ and $n = 3$. Substituting, we get $140 = 30(3) + 0.1m \Leftrightarrow 140 = 90 + 0.1m \Leftrightarrow 50 = 0.1m \Leftrightarrow m = 500$. So the rental was driven 500 miles.
21. (a) (i) For an all-electric car, the energy cost of driving x miles is $C_e = 0.04x$.
 (ii) For an average gasoline powered car, the energy cost of driving x miles is $C_g = 0.12x$.
 (b) (i) The cost of driving 10,000 miles with an all-electric car is $C_e = 0.04(10,000) = \$400$.
 (ii) The cost of driving 10,000 miles with a gasoline powered car is $C_g = 0.12(10,000) = \$1200$.
22. (a) If the width is 20, then the length is 40, so the volume is $20 \cdot 20 \cdot 40 = 16,000 \text{ in}^3$.
 (b) In terms of width, $V = x \cdot x \cdot 2x = 2x^3$.
23. (a) The GPA is $\frac{4a + 3b + 2c + 1d + 0f}{a + b + c + d + f} = \frac{4a + 3b + 2c + d}{a + b + c + d + f}$.
 (b) Using $a = 2 \cdot 3 = 6$, $b = 4$, $c = 3 \cdot 3 = 9$, and $d = f = 0$ in the formula from part (a), we find the GPA to be $\frac{4 \cdot 6 + 3 \cdot 4 + 2 \cdot 9}{6 + 4 + 9} = \frac{54}{19} \approx 2.84$.

P.2 THE REAL NUMBERS

1. (a) The natural numbers are $\{1, 2, 3, \dots\}$.
 (b) The numbers $\{\dots, -3, -2, -1, 0\}$ are integers but not natural numbers.
 (c) Any irreducible fraction $\frac{p}{q}$ with $q \neq 1$ is rational but is not an integer. Examples: $\frac{3}{2}$, $-\frac{5}{12}$, $\frac{1729}{23}$.
 (d) Any number which cannot be expressed as a ratio $\frac{p}{q}$ of two integers is irrational. Examples are $\sqrt{2}$, $\sqrt{3}$, π , and e .
2. (a) $ab = ba$; Commutative Property of Multiplication
 (b) $a + (b + c) = (a + b) + c$; Associative Property of Addition
 (c) $a(b + c) = ab + ac$; Distributive Property
3. The set of numbers between but not including 2 and 7 can be written as (a) $\{x \mid 2 < x < 7\}$ in interval notation, or (b) $(2, 7)$ in interval notation.
4. The symbol $|x|$ stands for the *absolute value* of the number x . If x is not 0, then the sign of $|x|$ is always *positive*.
5. The distance between a and b on the real line is $d(a, b) = |b - a|$. So the distance between -5 and 2 is $|2 - (-5)| = 7$.
6. (a) Yes, the sum of two rational numbers is rational: $\frac{a}{b} + \frac{c}{d} = \frac{ad + bc}{bd}$.
 (b) No, the sum of two irrational numbers can be irrational ($\pi + \pi = 2\pi$) or rational ($-\pi + \pi = 0$).
7. (a) No: $a - b = -(b - a) \neq b - a$ in general.
 (b) No; by the Distributive Property, $-2(a - 5) = -2a + -2(-5) = -2a + 10 \neq -2a - 10$.
8. (a) Yes, absolute values (such as the distance between two different numbers) are always positive.
 (b) Yes, $|b - a| = |a - b|$.

9. (a) Natural number: 100
 (b) Integers: 0, 100, -8
 (c) Rational numbers: -1.5 , 0 , $\frac{5}{2}$, 2.71 , $3.1\bar{4}$, 100 , -8
 (d) Irrational numbers: $\sqrt{7}$, $-\pi$
11. Commutative Property of addition
13. Associative Property of addition
15. Distributive Property
17. Commutative Property of multiplication
19. $x + 3 = 3 + x$
21. $4(A + B) = 4A + 4B$
23. $3(x + y) = 3x + 3y$
25. $4(2m) = (4 \cdot 2)m = 8m$
27. $-\frac{5}{2}(2x - 4y) = -\frac{5}{2}(2x) + \frac{5}{2}(4y) = -5x + 10y$
29. (a) $\frac{3}{10} + \frac{4}{15} = \frac{9}{30} + \frac{8}{30} = \frac{17}{30}$
 (b) $\frac{1}{4} + \frac{1}{5} = \frac{5}{20} + \frac{4}{20} = \frac{9}{20}$
31. (a) $\frac{2}{3}\left(6 - \frac{3}{2}\right) = \frac{2}{3} \cdot 6 - \frac{2}{3} \cdot \frac{3}{2} = 4 - 1 = 3$
 (b) $\left(3 + \frac{1}{4}\right)\left(1 - \frac{4}{5}\right) = \left(\frac{12}{4} + \frac{1}{4}\right)\left(\frac{5}{5} - \frac{4}{5}\right) = \frac{13}{4} \cdot \frac{1}{5} = \frac{13}{20}$
33. (a) $2 \cdot 3 = 6$ and $2 \cdot \frac{7}{2} = 7$, so $3 < \frac{7}{2}$
 (b) $-6 > -7$
 (c) $3.5 = \frac{7}{2}$
35. (a) False
 (b) True
37. (a) True (b) False
39. (a) $x > 0$ (b) $t < 4$
 (c) $a \geq \pi$ (d) $-5 < x < \frac{1}{3}$
 (e) $|p - 3| \leq 5$
41. (a) $A \cup B = \{1, 2, 3, 4, 5, 6, 7, 8\}$
 (b) $A \cap B = \{2, 4, 6\}$
10. (a) Natural number: $\sqrt{16} (= 4)$
 (b) Integers: -500 , $\sqrt{16}$, $-\frac{20}{5} (= -4)$
 (c) Rational numbers: 1.3 , $1.3333\dots$, 5.34 , -500 , $1\frac{2}{3}$,
 $\sqrt{16}$, $\frac{246}{579}$, $-\frac{20}{5}$
 (d) Irrational number: $\sqrt{5}$
12. Commutative Property of multiplication
14. Distributive Property
16. Distributive Property
18. Distributive Property
20. $7(3x) = (7 \cdot 3)x$
22. $5x + 5y = 5(x + y)$
24. $(a - b)8 = 8a - 8b$
26. $\frac{4}{3}(-6y) = \left[\frac{4}{3}(-6)\right]y = -8y$
28. (3a) $(b + c - 2d) = 3ab + 3ac - 6ad$
30. (a) $\frac{2}{3} - \frac{3}{5} = \frac{10}{15} - \frac{9}{15} = \frac{1}{15}$
 (b) $1 + \frac{5}{8} - \frac{1}{6} = \frac{24}{24} + \frac{15}{24} - \frac{4}{24} = \frac{35}{24}$
32. (a) $\frac{2}{\frac{2}{3}} - \frac{\frac{3}{2}}{2} = 2 \cdot \frac{3}{2} - \frac{2}{3} \cdot \frac{1}{2} = 3 - \frac{1}{3} = \frac{9}{3} - \frac{1}{3} = \frac{8}{3}$
 (b) $\frac{\frac{2}{5} + \frac{1}{2}}{\frac{1}{10} + \frac{3}{15}} = \frac{\frac{2}{5} + \frac{1}{2}}{\frac{1}{10} + \frac{1}{5}} = \frac{\frac{2}{5} + \frac{1}{2}}{\frac{1}{10} + \frac{1}{5}} \cdot \frac{10}{10} = \frac{4+5}{1+2} = \frac{9}{3} = 3$
34. (a) $3 \cdot \frac{2}{3} = 2$ and $3 \cdot 0.67 = 2.01$, so $\frac{2}{3} < 0.67$
 (b) $\frac{2}{3} > -0.67$
 (c) $|0.67| = |-0.67|$
36. (a) False: $\sqrt{3} \approx 1.73205 < 1.7325$.
 (b) False
38. (a) True (b) True
40. (a) $y < 0$ (b) $z > 1$
 (c) $b \leq 8$ (d) $0 < w \leq 17$
 (e) $|y - \pi| \geq 2$
42. (a) $B \cup C = \{2, 4, 6, 7, 8, 9, 10\}$
 (b) $B \cap C = \{8\}$

43. (a) $A \cup C = \{1, 2, 3, 4, 5, 6, 7, 8, 9, 10\}$

(b) $A \cap C = \{7\}$

45. (a) $B \cup C = \{x \mid x \leq 5\}$

(b) $B \cap C = \{x \mid -1 < x < 4\}$

47. $(-3, 0) = \{x \mid -3 < x < 0\}$

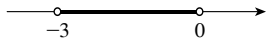

49. $[2, 8) = \{x \mid 2 \leq x < 8\}$

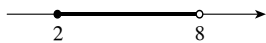

51. $[2, \infty) = \{x \mid x \geq 2\}$



53. $x \leq 1 \Leftrightarrow x \in (-\infty, 1]$



55. $-2 < x \leq 1 \Leftrightarrow x \in (-2, 1]$

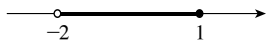

57. $x > -1 \Leftrightarrow x \in (-1, \infty)$



59. (a) $[-3, 5]$ (b) $(-3, 5]$

61. $(-2, 0) \cup (-1, 1) = (-2, 1)$



63. $[-4, 6] \cap [0, 8) = [0, 6]$



65. $(-\infty, -4) \cup (4, \infty)$

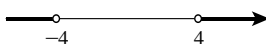

44. (a) $A \cup B \cup C = \{1, 2, 3, 4, 5, 6, 7, 8, 9, 10\}$

(b) $A \cap B \cap C = \emptyset$

46. (a) $A \cap C = \{x \mid -1 < x \leq 5\}$

(b) $A \cap B = \{x \mid -2 \leq x < 4\}$

48. $(2, 8] = \{x \mid 2 < x \leq 8\}$

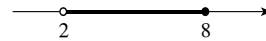

50. $\left[-6, -\frac{1}{2}\right] = \left\{x \mid -6 \leq x \leq -\frac{1}{2}\right\}$

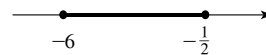

52. $(-\infty, 1) = \{x \mid x < 1\}$



54. $1 \leq x \leq 2 \Leftrightarrow x \in [1, 2]$



56. $x \geq -5 \Leftrightarrow x \in [-5, \infty)$

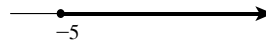

58. $-5 < x < 2 \Leftrightarrow x \in (-5, 2)$



60. (a) $[0, 2)$ (b) $(-2, 0]$

62. $(-2, 0) \cap (-1,) = (-1, 0)$



64. $[-4, 6] \cup [0, 8) = [-4, 8)$



66. $(-\infty, 6] \cap (2, 10) = (2, 6]$

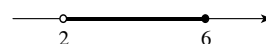

67. (a) $|100| = 100$

(b) $|-73| = 73$

69. (a) $||-6| - |-4|| = |6 - 4| = |2| = 2$

(b) $\left|\frac{-1}{|-1|}\right| = \frac{-1}{1} = -1$

71. (a) $|(-2) \cdot 6| = |-12| = 12$

(b) $\left|(-\frac{1}{3})(-15)\right| = |5| = 5$

73. $|(-2) - 3| = |-5| = 5$

75. (a) $|17 - 2| = 15$

(b) $|21 - (-3)| = |21 + 3| = |24| = 24$

(c) $\left|-\frac{3}{10} - \frac{11}{8}\right| = \left|-\frac{12}{40} - \frac{55}{40}\right| = \left|-\frac{67}{40}\right| = \frac{67}{40}$

77. (a) Let $x = 0.777\dots$. So $10x = 7.777\dots \Leftrightarrow x = 0.777\dots \Leftrightarrow 9x = 7$. Thus, $x = \frac{7}{9}$.

(b) Let $x = 0.2888\dots$. So $100x = 28.8888\dots \Leftrightarrow 10x = 2.8888\dots \Leftrightarrow 90x = 26$. Thus, $x = \frac{26}{90} = \frac{13}{45}$.

(c) Let $x = 0.575757\dots$. So $100x = 57.5757\dots \Leftrightarrow x = 0.5757\dots \Leftrightarrow 99x = 57$. Thus, $x = \frac{57}{99} = \frac{19}{33}$.

78. (a) Let $x = 5.2323\dots$. So $100x = 523.2323\dots \Leftrightarrow 1x = 5.2323\dots \Leftrightarrow 99x = 518$. Thus, $x = \frac{518}{99}$.

(b) Let $x = 1.3777\dots$. So $100x = 137.7777\dots \Leftrightarrow 10x = 13.7777\dots \Leftrightarrow 90x = 124$. Thus, $x = \frac{124}{90} = \frac{62}{45}$.

(c) Let $x = 2.13535\dots$. So $1000x = 2135.3535\dots \Leftrightarrow 10x = 21.3535\dots \Leftrightarrow 990x = 2114$. Thus, $x = \frac{2114}{990} = \frac{1057}{495}$.

79. $\pi > 3$, so $|\pi - 3| = \pi - 3$.

80. $\sqrt{2} > 1$, so $|1 - \sqrt{2}| = \sqrt{2} - 1$.

81. $a < b$, so $|a - b| = -(a - b) = b - a$.

82. $a + b + |a - b| = a + b + b - a = 2b$

83. (a) $-a$ is negative because a is positive.

(b) bc is positive because the product of two negative numbers is positive.

(c) $a - ba + (-b)$ is positive because it is the sum of two positive numbers.

(d) $ab + ac$ is negative: each summand is the product of a positive number and a negative number, and the sum of two negative numbers is negative.

84. (a) $-b$ is positive because b is negative.

(b) $a + bc$ is positive because it is the sum of two positive numbers.

(c) $c - a = c + (-a)$ is negative because c and $-a$ are both negative.

(d) ab^2 is positive because both a and b^2 are positive.

85. Distributive Property

86.

Day	T_O	T_G	$T_O - T_G$	$ T_O - T_G $
Sunday	68	77	-9	9
Monday	72	75	-3	3
Tuesday	74	74	0	0
Wednesday	80	75	5	5
Thursday	77	69	8	8
Friday	71	70	1	1
Saturday	70	71	-1	1

$T_O - T_G$ gives more information because it tells us which city had the higher temperature.

87. (a) When $L = 60$, $x = 8$, and $y = 6$, we have $L + 2(x + y) = 60 + 2(8 + 6) = 60 + 28 = 88$. Because $88 \leq 108$ the post office will accept this package.

When $L = 48$, $x = 24$, and $y = 24$, we have $L + 2(x + y) = 48 + 2(24 + 24) = 48 + 96 = 144$, and since $144 \not\leq 108$, the post office will *not* accept this package.

(b) If $x = y = 9$, then $L + 2(9 + 9) \leq 108 \Leftrightarrow L + 36 \leq 108 \Leftrightarrow L \leq 72$. So the length can be as long as 72 in. = 6 ft.

88. Let $x = \frac{m_1}{n_1}$ and $y = \frac{m_2}{n_2}$ be rational numbers. Then $x + y = \frac{m_1}{n_1} + \frac{m_2}{n_2} = \frac{m_1n_2 + m_2n_1}{n_1n_2}$,

$x - y = \frac{m_1}{n_1} - \frac{m_2}{n_2} = \frac{m_1n_2 - m_2n_1}{n_1n_2}$, and $x \cdot y = \frac{m_1}{n_1} \cdot \frac{m_2}{n_2} = \frac{m_1m_2}{n_1n_2}$. This shows that the sum, difference, and product of two rational numbers are again rational numbers. However the product of two irrational numbers is not necessarily irrational; for example, $\sqrt{2} \cdot \sqrt{2} = 2$, which is rational. Also, the sum of two irrational numbers is not necessarily irrational; for example, $\sqrt{2} + (-\sqrt{2}) = 0$ which is rational.

89. $\frac{1}{2} + \sqrt{2}$ is irrational. If it were rational, then by Exercise 6(a), the sum $(\frac{1}{2} + \sqrt{2}) + (-\frac{1}{2}) = \sqrt{2}$ would be rational, but this is not the case.

Similarly, $\frac{1}{2} \cdot \sqrt{2}$ is irrational.

(a) Following the hint, suppose that $r + t = q$, a rational number. Then by Exercise 6(a), the sum of the two rational numbers $r + t$ and $-r$ is rational. But $(r + t) + (-r) = t$, which we know to be irrational. This is a contradiction, and hence our original premise—that $r + t$ is rational—was false.

(b) r is rational, so $r = \frac{a}{b}$ for some integers a and b . Let us assume that $rt = q$, a rational number. Then by definition,

$q = \frac{c}{d}$ for some integers c and d . But then $rt = q \Leftrightarrow \frac{a}{b}t = \frac{c}{d}$, whence $t = \frac{bc}{ad}$, implying that t is rational. Once again we have arrived at a contradiction, and we conclude that the product of a rational number and an irrational number is irrational.

90.

x	1	2	10	100	1000
$\frac{1}{x}$	1	$\frac{1}{2}$	$\frac{1}{10}$	$\frac{1}{100}$	$\frac{1}{1000}$

As x gets large, the fraction $1/x$ gets small. Mathematically, we say that $1/x$ goes to zero.

x	1	0.5	0.1	0.01	0.001
$\frac{1}{x}$	1	$\frac{1}{0.5} = 2$	$\frac{1}{0.1} = 10$	$\frac{1}{0.01} = 100$	$\frac{1}{0.001} = 1000$

As x gets small, the fraction $1/x$ gets large. Mathematically, we say that $1/x$ goes to infinity.

91. (a) Construct the number $\sqrt{2}$ on the number line by transferring the length of the hypotenuse of a right triangle with legs of length 1 and 1.

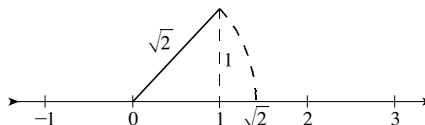

- (b) Construct a right triangle with legs of length 1 and 2. By the Pythagorean Theorem, the length of the hypotenuse is $\sqrt{1^2 + 2^2} = \sqrt{5}$. Then transfer the length of the hypotenuse to the number line.

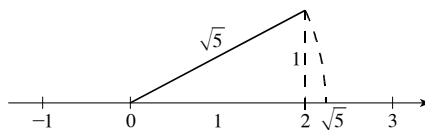

- (c) Construct a right triangle with legs of length $\sqrt{2}$ and 2 [construct $\sqrt{2}$ as in part (a)]. By the Pythagorean Theorem, the length of the hypotenuse is $\sqrt{(\sqrt{2})^2 + 2^2} = \sqrt{6}$. Then transfer the length of the hypotenuse to the number line.

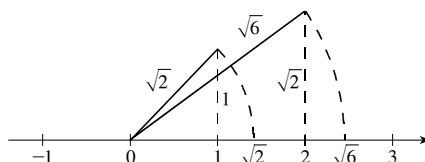

92. (a) Subtraction is not commutative. For example, $5 - 1 \neq 1 - 5$.
 (b) Division is not commutative. For example, $5 \div 1 \neq 1 \div 5$.
 (c) Putting on your socks and putting on your shoes are not commutative. If you put on your socks first, then your shoes, the result is not the same as if you proceed the other way around.
 (d) Putting on your hat and putting on your coat are commutative. They can be done in either order, with the same result.
 (e) Washing laundry and drying it are not commutative.
 (f) Answers will vary.
 (g) Answers will vary.

93. Answers will vary.

94. (a) If $x = 2$ and $y = 3$, then $|x + y| = |2 + 3| = |5| = 5$ and $|x| + |y| = |2| + |3| = 5$.
 If $x = -2$ and $y = -3$, then $|x + y| = |-5| = 5$ and $|x| + |y| = 5$.
 If $x = -2$ and $y = 3$, then $|x + y| = |-2 + 3| = 1$ and $|x| + |y| = 5$.
 In each case, $|x + y| \leq |x| + |y|$ and the Triangle Inequality is satisfied.

- (b) *Case 0:* If either x or y is 0, the result is equality, trivially.

$$\text{Case 1: If } x \text{ and } y \text{ have the same sign, then } |x + y| = \begin{cases} x + y & \text{if } x \text{ and } y \text{ are positive} \\ -(x + y) & \text{if } x \text{ and } y \text{ are negative} \end{cases} = |x| + |y|.$$

Case 2: If x and y have opposite signs, then suppose without loss of generality that $x < 0$ and $y > 0$. Then $|x + y| < |-x + y| = |x| + |y|$.

P.3 INTEGER EXPONENTS AND SCIENTIFIC NOTATION

- Using exponential notation we can write the product $5 \cdot 5 \cdot 5 \cdot 5 \cdot 5 \cdot 5$ as 5^6 .
- Yes, there is a difference: $(-5)^4 = (-5)(-5)(-5)(-5) = 625$, while $-5^4 = -(5 \cdot 5 \cdot 5 \cdot 5) = -625$.
- In the expression 3^4 , the number 3 is called the *base* and the number 4 is called the *exponent*.
- When we multiply two powers with the same base, we *add* the exponents. So $3^4 \cdot 3^5 = 3^9$.
- When we divide two powers with the same base, we *subtract* the exponents. So $\frac{3^5}{3^2} = 3^3$.
- When we raise a power to a new power, we *multiply* the exponents. So $(3^4)^2 = 3^8$.

$$7. \text{ (a) } 2^{-1} = \frac{1}{2} \quad \text{(b) } 2^{-3} = \frac{1}{8} \quad \text{(c) } \left(\frac{1}{2}\right)^{-1} = 2 \quad \text{(d) } \frac{1}{2^{-3}} = 2^3 = 8$$

8. Scientists express very large or very small numbers using *scientific* notation. In scientific notation, 8,300,000 is 8.3×10^6 and 0.0000327 is 3.27×10^{-5} .

$$9. \text{ (a) No, } \left(\frac{2}{3}\right)^{-2} = \left(\frac{3}{2}\right)^2 = \frac{9}{4}. \quad \text{(b) Yes, } (-5)^4 = 625 \text{ and } -5^4 = -(5^4) = -625.$$

$$10. \text{ (a) No, } (x^2)^3 = x^{2 \cdot 3} = x^6. \quad \text{(b) No, } (2x^4)^3 = 2^3 \cdot (x^4)^3 = 8x^{12}.$$

$$11. \text{ (a) } -2^6 = -64 \quad \text{(b) } (-2)^6 = 64 \quad \text{(c) } \left(\frac{1}{5}\right)^2 \cdot (-3)^3 = \frac{1^2(-3)^3}{5^2} = -\frac{27}{25}$$

$$12. \text{ (a) } (-5)^3 = -125 \quad \text{(b) } -5^3 = -125 \quad \text{(c) } (-5)^2 \cdot \left(\frac{2}{5}\right)^2 = \frac{(-5)^2(2)^2}{5^2} = 4$$

$$13. \text{ (a) } \left(\frac{5}{3}\right)^0 \cdot 2^{-1} = \frac{1}{2} \quad \text{(b) } \frac{2^{-3}}{3^0} = \frac{1}{2^3} = \frac{1}{8} \quad \text{(c) } \left(\frac{1}{4}\right)^{-2} = 4^2 = 16$$

$$14. \text{ (a) } -2^{-3} \cdot (-2)^0 = -\frac{1}{2^3} = -\frac{1}{8} \quad \text{(b) } -2^3 \cdot (-2)^0 = -2^3 = -8 \quad \text{(c) } \left(\frac{-2}{3}\right)^{-3} = \frac{3^3}{(-2)^3} = -\frac{27}{8}$$

$$15. \text{ (a) } 5^3 \cdot 5 = 5^4 = 625 \quad \text{(b) } 3^2 \cdot 3^0 = 3^2 = 9 \quad \text{(c) } (2^2)^3 = 2^6 = 64$$

$$16. \text{ (a) } 3^8 \cdot 3^5 = 3^{13} = 1,594,323 \quad \text{(b) } 6^0 \cdot 6 = 6 \quad \text{(c) } (5^4)^2 = 5^8 = 390,625$$

$$17. \text{ (a) } 5^4 \cdot 5^{-2} = 5^2 = 25 \quad \text{(b) } \frac{10^7}{10^4} = 10^3 = 1000 \quad \text{(c) } \frac{3^2}{3^4} = \frac{1}{3^2} = \frac{1}{9}$$

$$18. \text{ (a) } 3^{-3} \cdot 3^{-1} = 3^{-4} = \frac{1}{3^4} = \frac{1}{81} \quad \text{(b) } \frac{5^4}{5} = 5^3 = 125 \quad \text{(c) } \frac{7^2}{7^5} = \frac{1}{7^3} = \frac{1}{343}$$

$$19. \text{ (a) } x^2 x^3 = x^{2+3} = x^5 \quad \text{(b) } (-x^2)^3 = (-1)^3 x^{2 \cdot 3} = -x^6 \quad \text{(c) } t^{-3} t^5 = t^{-3+5} = t^2$$

$$20. \text{ (a) } y^5 \cdot y^2 = y^{5+2} = y^7 \quad \text{(b) } (8x)^2 = 8^2 x^2 = 64x^2 \quad \text{(c) } x^4 x^{-3} = x^{4-3} = x$$

$$21. \text{ (a) } x^{-5} \cdot x^3 = x^{-5+3} = x^{-2} = \frac{1}{x^2} \quad \text{(b) } w^{-2} w^{-4} w^5 = w^{-2-4+5} = w^{-1} = \frac{1}{w}$$

$$\text{(c) } \frac{y^{10} y^0}{y^7} = y^{10+0-7} = y^3$$

$$22. \text{ (a) } y^2 \cdot y^{-5} = y^{2-5} = y^{-3} = \frac{1}{y^3} \quad \text{(b) } z^5 z^{-3} z^{-4} = z^{5-3-4} = z^{-2} = \frac{1}{z^2} \quad \text{(c) } \frac{x^6}{x^{10}} = x^{6-10} = \frac{1}{x^4}$$

$$23. \text{ (a) } \frac{a^9 a^{-2}}{a} = a^{9-2-1} = a^6 \quad \text{(b) } (a^2 a^4)^3 = (a^{2+4})^3 = (a^6)^3 = a^{6 \cdot 3} = a^{18}$$

$$\text{(c) } (2x)^2 (5x^6) = 2^2 x^2 \cdot 5x^6 = 20x^{2+6} = 20x^8$$

$$24. \text{ (a) } \frac{z^2 z^4}{z^3 z^{-1}} = \frac{z^{2+4}}{z^{3-1}} = \frac{z^6}{z^2} = z^{6-2} = z^4 \quad \text{(b) } (2a^3 a^2)^4 = (2a^{3+2})^4 = (2a^5)^4 = 2^4 a^{5 \cdot 4} = 16a^{20}$$

$$\text{(c) } (-3z^2)^3 (2z^3) = (-3)^3 z^{2 \cdot 3} \cdot 2z^3 = -54z^{6+3} = -54z^9$$

$$25. \text{ (a) } (3x^2 y)(2x^3) = 3 \cdot 2x^{2+3} y = 6x^5 y$$

$$\text{(b) } (2a^2 b^{-1})(3a^{-2} b^2) = 2 \cdot 3a^{2-2} b^{-1+2} = 6b$$

- (c) $(4y^2)(x^4y)^2 = 4y^2x^4 \cdot 2y^2 = 4x^8y^{2+2} = 4x^8y^4$
26. (a) $(4x^3y^2)(7y^5) = 4 \cdot 7x^3y^{2+5} = 28x^3y^7$
- (b) $(9y^{-2}z^2)(3y^3z) = 9 \cdot 3y^{-2+3}z^{2+1} = 27yz^3$
- (c) $(8x^7y^2)\left(\frac{1}{2}x^3y\right)^{-2} = \frac{8x^7y^2}{\left(\frac{1}{2}x^3y\right)^2} = \frac{2^2 \cdot 8x^7y^2}{x^3 \cdot 2y^2} = \frac{32x^7y^2}{x^6y^2} = 32x^{7-6}y^{2-2} = 32x$
27. (a) $(2x^2y^3)^2(3y) = 2^2x^{2 \cdot 2}y^{3 \cdot 2} \cdot 3y = 12x^4y^7$
- (b) $\frac{x^2y^{-1}}{x^{-5}} = x^{2-(-5)}y^{-1} = x^7y^{-1} = \frac{x^7}{y}$
- (c) $\left(\frac{x^2y}{3}\right)^3 = \frac{x^{2 \cdot 3}y^3}{3^3} = \frac{x^6y^3}{27}$
28. (a) $(5x^{-4}y^3)(8x^3)^2 = 5x^{-4}y^3 \cdot 8^2x^{3 \cdot 2} = 5 \cdot 8^2x^{-4+6}y^3 = 320x^2y^3$
- (b) $\frac{y^{-2}z^{-3}}{y^{-1}} = \frac{y}{y^2z^3} = \frac{1}{yz^3}$
- (c) $\left(\frac{a^3b^{-2}}{b^3}\right)^2 = \frac{a^6b^{-4}}{b^6} = \frac{a^6}{b^{10}}$
29. (a) $(x^3y^3)^{-1} = \frac{1}{x^3y^3}$
- (b) $(a^2b^{-2})^{-3}(a^3)^{-2} = a^{2(-3)}b^{-2(-3)}a^{3(-2)} = a^{-6}b^6a^{-6} = \frac{b^6}{a^{12}}$
- (c) $\left(\frac{x^2}{y^{-2}}\right)^{-2}\left(\frac{2y^{-3}}{x^2}\right)^3 = x^{2(-2)}y^{-(-2)(-2)} \cdot 2^3y^{-3(3)}x^{-2(3)} = x^{-4}y^{-4} \cdot 8y^{-9}x^{-6} = 8x^{-4-6}y^{-4-9} = \frac{8}{x^{10}y^{13}}$
30. (a) $(x^{-2}y^4)^{-3} = \left(\frac{y^4}{x^2}\right)^{-3} = \left(\frac{x^2}{y^4}\right)^3 = \frac{x^6}{y^{12}}$
- (b) $(y^2)^{-1}(2x^{-3}y^4)^{-3} = y^{-2}2^{-3}x^{-3(-3)}y^{4(-3)} = \frac{x^9}{8y^{14}}$
- (c) $\left(\frac{2a^{-1}}{b^{-2}}\right)^{-3}\left(\frac{b^{-1}}{2a^2}\right)^2 = 2^{-3}a^{-1(-3)}b^{-(-2)(-3)}b^{-1(2)}2^{-2}a^{-2(2)} = \frac{1}{32ab^8}$
31. (a) $\frac{3x^{-2}y^5}{9x^{-3}y^2} = \frac{xy^3}{3}$
- (b) $\left(\frac{2x^3y^{-1}}{y^2}\right)^{-2} = \left(\frac{2x^3}{y^3}\right)^{-2} = \frac{y^{3 \cdot 2}}{2^2x^{3 \cdot 2}} = \frac{y^6}{4x^6}$
- (c) $\left(\frac{y^{-1}}{x^{-2}}\right)^{-1}\left(\frac{3x^{-3}}{y^2}\right)^{-2} = y^{-1(-1)}x^{-(-2)(-1)}3^{-2}x^{-3(-2)}y^{-2(-2)} = \frac{x^4y^5}{9}$
32. (a) $\frac{\frac{1}{2}a^{-3}b^{-4}}{2a^{-5}b^{-1}} = \frac{1}{2} \cdot 2^{-1}a^{-3-(-5)}b^{-4-(-1)} = \frac{1}{4}a^2b^{-3} = \frac{a^2}{4b^3}$

$$(b) \left(\frac{x^2y}{5x^4}\right)^{-2} = \left(\frac{5x^4}{x^2y}\right)^2 = \left(\frac{5x^2}{y}\right)^2 = \frac{25x^4}{y^2}$$

$$(c) \left(\frac{2y^{-1}z}{z^2}\right)^{-1} \left(\frac{y}{3z^2}\right)^2 = \left(\frac{z}{2y}\right)^{-1} \left(\frac{y^2}{9z^4}\right) = \frac{y^3}{18z^3}$$

$$33. (a) \left(\frac{3a}{b^3}\right)^{-1} = 3^{-1}a^{-1}b^{-3(-1)} = \frac{b^3}{3a}$$

$$(b) \left(\frac{q^{-1}r^{-1}s^{-2}}{r^{-5}sq^{-8}}\right)^{-1} = \frac{r^{-5}sq^{-8}}{q^{-1}r^{-1}s^{-2}} = q^{-8-(-1)}r^{-5-(-1)}s^{1-(-2)} = \frac{s^3}{q^7r^4}$$

$$34. (a) \left(\frac{s^2t^{-4}}{5s^{-1}t}\right)^{-2} = s^{2(-2)-(-1)(-2)}t^{-4(-2)-1(-2)}5^{-(-2)} = \frac{25t^{10}}{s^6}$$

$$(b) \left(\frac{xy^{-2}z^{-3}}{x^2y^3z^{-4}}\right)^{-3} = x^{-3-2(-3)}y^{-2(-3)-3(-3)}z^{-3(-3)-(-4)(-3)} = \frac{x^3y^{15}}{z^3}$$

$$35. (a) 69,300,000 = 6.93 \times 10^7$$

$$(b) 7,200,000,000,000 = 7.2 \times 10^{12}$$

$$(c) 0.000028536 = 2.8536 \times 10^{-5}$$

$$(d) 0.0001213 = 1.213 \times 10^{-4}$$

$$36. (a) 129,540,000 = 1.2954 \times 10^8$$

$$(b) 7,259,000,000 = 7.259 \times 10^9$$

$$(c) 0.0000000014 = 1.4 \times 10^{-9}$$

$$(d) 0.0007029 = 7.029 \times 10^{-4}$$

$$37. (a) 3.19 \times 10^5 = 319,000$$

$$(b) 2.721 \times 10^8 = 272,100,000$$

$$(c) 2.670 \times 10^{-8} = 0.00000002670$$

$$(d) 9.999 \times 10^{-9} = 0.000000009999$$

$$38. (a) 7.1 \times 10^{14} = 710,000,000,000,000$$

$$(b) 6 \times 10^{12} = 6,000,000,000,000$$

$$(c) 8.55 \times 10^{-3} = 0.00855$$

$$(d) 6.257 \times 10^{-10} = 0.0000000006257$$

$$39. (a) 5,900,000,000,000 \text{ mi} = 5.9 \times 10^{12} \text{ mi}$$

$$(b) 0.00000000000004 \text{ cm} = 4 \times 10^{-13} \text{ cm}$$

$$(c) 33 \text{ billion billion molecules} = 33 \times 10^9 \times 10^9 = 3.3 \times 10^{19} \text{ molecules}$$

$$40. (a) 93,000,000 \text{ mi} = 9.3 \times 10^7 \text{ mi}$$

$$(b) 0.000000000000000000000053 \text{ g} = 5.3 \times 10^{-23} \text{ g}$$

$$(c) 5,970,000,000,000,000,000,000,000 \text{ kg} = 5.97 \times 10^{24} \text{ kg}$$

$$41. (7.2 \times 10^{-9})(1.806 \times 10^{-12}) = 7.2 \times 1.806 \times 10^{-9} \times 10^{-12} \approx 13.0 \times 10^{-21} = 1.3 \times 10^{-20}$$

$$42. (1.062 \times 10^{24})(8.61 \times 10^{19}) = 1.062 \times 8.61 \times 10^{24} \times 10^{19} \approx 9.14 \times 10^{43}$$

$$43. \frac{1.295643 \times 10^9}{(3.610 \times 10^{-17})(2.511 \times 10^6)} = \frac{1.295643}{3.610 \times 2.511} \times 10^{9+17-6} \approx 0.1429 \times 10^{19} = 1.429 \times 10^{19}$$

$$44. \frac{(73.1)(1.6341 \times 10^{28})}{0.0000000019} = \frac{(7.31 \times 10)(1.6341 \times 10^{28})}{1.9 \times 10^{-9}} = \frac{7.31 \times 1.6341}{1.9} \times 10^{1+28-(-9)} \approx 6.3 \times 10^{38}$$

$$45. \frac{(0.0000162)(0.01582)}{(594621000)(0.0058)} = \frac{(1.62 \times 10^{-5})(1.582 \times 10^{-2})}{(5.94621 \times 10^8)(5.8 \times 10^{-3})} = \frac{1.62 \times 1.582}{5.94621 \times 5.8} \times 10^{-5-2-8+3} = 0.074 \times 10^{-12} \\ = 7.4 \times 10^{-14}$$

$$46. \frac{(3.542 \times 10^{-6})^9}{(5.05 \times 10^4)^{12}} = \frac{(3.542)^9 \times 10^{-54}}{(5.05)^{12} \times 10^{48}} = \frac{87747.96}{275103767.10} \times 10^{-54-48} \approx 3.19 \times 10^{-4} \times 10^{-102} \approx 3.19 \times 10^{-106}$$

47. $|10^{50} - 10^{10}| < 10^{50}$, whereas $|10^{101} - 10^{100}| = 10^{100} |10 - 1| = 9 \times 10^{100} > 10^{50}$. So 10^{10} is closer to 10^{50} than 10^{100} is to 10^{101} .

48. (a) b^5 is negative since a negative number raised to an odd power is negative.

(b) b^{10} is positive since a negative number raised to an even power is positive.

(c) ab^2c^3 we have (positive) (negative)² (negative)³ = (positive) (positive) (negative) which is negative.

(d) Since $b - a$ is negative, $(b - a)^3 = (\text{negative})^3$ which is negative.

(e) Since $b - a$ is negative, $(b - a)^4 = (\text{negative})^4$ which is positive.

(f) $\frac{a^3c^3}{b^6c^6} = \frac{(\text{positive})^3(\text{negative})^3}{(\text{negative})^6(\text{negative})^6} = \frac{(\text{positive})(\text{negative})}{(\text{positive})(\text{positive})} = \frac{\text{negative}}{\text{positive}}$ which is negative.

49. Since one light year is 5.9×10^{12} miles, Centauri is about $4.3 \times 5.9 \times 10^{12} \approx 2.54 \times 10^{13}$ miles away or 25,400,000,000,000 miles away.

$$50. 9.3 \times 10^7 \text{ mi} = 186,000 \frac{\text{mi}}{\text{s}} \times t \text{ s} \Leftrightarrow t = \frac{9.3 \times 10^7}{186,000} \text{ s} = 500 \text{ s} = 8\frac{1}{3} \text{ min.}$$

$$51. \text{Volume} = (\text{average depth}) (\text{area}) = (3.7 \times 10^3 \text{ m}) (3.6 \times 10^{14} \text{ m}^2) \left(\frac{10^3 \text{ liters}}{\text{m}^3} \right) \approx 1.33 \times 10^{21} \text{ liters}$$

$$52. \text{Each person's share is equal to } \frac{\text{national debt}}{\text{population}} = \frac{1.674 \times 10^{13}}{3.164 \times 10^8} \approx \$52,900.$$

53. The number of molecules is equal to

$$(\text{volume}) \cdot \left(\frac{\text{liters}}{\text{m}^3} \right) \cdot \left(\frac{\text{molecules}}{22.4 \text{ liters}} \right) = (5 \cdot 10 \cdot 3) \cdot (10^3) \cdot \left(\frac{6.02 \times 10^{23}}{22.4} \right) \approx 4.03 \times 10^{27}$$

54. (a)

Person	Weight	Height	BMI = $703 \frac{W}{H^2}$	Result
Brian	295 lb	5 ft 10 in. = 70 in.	42.32	obese
Linda	105 lb	5 ft 6 in. = 66 in.	16.95	underweight
Larry	220 lb	6 ft 4 in. = 76 in.	26.78	overweight
Helen	110 lb	5 ft 2 in. = 62 in.	20.12	normal

(b) Answers will vary.

55.

Year	Total interest
1	\$152.08
2	308.79
3	470.26
4	636.64
5	808.08

56. Since $10^6 = 10^3 \cdot 10^3$ it would take 1000 days ≈ 2.74 years to spend the million dollars.

Since $10^9 = 10^3 \cdot 10^6$ it would take $10^6 = 1,000,000$ days ≈ 2739.72 years to spend the billion dollars.

57. (a) $\frac{18^5}{9^5} = \left(\frac{18}{9}\right)^5 = 2^5 = 32$

(b) $20^6 \cdot (0.5)^6 = (20 \cdot 0.5)^6 = 10^6 = 1,000,000$

58. (a) We wish to prove that $\frac{a^m}{a^n} = a^{m-n}$ for positive integers $m > n$. By definition,

$$a^k = \underbrace{a \cdot a \cdots a}_{k \text{ factors}}. \text{ Thus, } \frac{a^m}{a^n} = \frac{\overbrace{a \cdot a \cdots a}^{m \text{ factors}}}{\underbrace{a \cdot a \cdots a}_{n \text{ factors}}}. \text{ Because } m > n, m - n > 0, \text{ so we can write}$$

$$\frac{a^m}{a^n} = \frac{\overbrace{a \cdot a \cdots a}^{n \text{ factors}} \cdot \overbrace{a \cdot a \cdots a}^{m-n \text{ factors}}}{\underbrace{a \cdot a \cdots a}_{n \text{ factors}}} = \frac{\overbrace{a \cdot a \cdots a}^{m-n \text{ factors}}}{1} = a^{m-n}.$$

(b) We wish to prove that $\left(\frac{a}{b}\right)^n = \frac{a^n}{b^n}$ for positive integers $m > n$. By definition,

$$\left(\frac{a}{b}\right)^n = \underbrace{\frac{a}{b} \cdot \frac{a}{b} \cdots \frac{a}{b}}_{n \text{ factors}} = \frac{\overbrace{a \cdot a \cdots a}^{n \text{ factors}}}{\underbrace{b \cdot b \cdots b}_{n \text{ factors}}} = \frac{a^n}{b^n}.$$

59. (a) We wish to prove that $\left(\frac{a}{b}\right)^{-n} = \frac{b^n}{a^n}$. By definition, and using the result from Exercise 58(b),

$$\left(\frac{a}{b}\right)^{-n} = \frac{1}{\left(\frac{a}{b}\right)^n} = \frac{1}{\frac{a^n}{b^n}} = \frac{b^n}{a^n}.$$

(b) We wish to prove that $\frac{a^{-n}}{b^{-m}} = \frac{b^m}{a^n}$. By definition, $\frac{a^{-n}}{b^{-m}} = \frac{\frac{1}{a^n}}{\frac{1}{b^m}} = \frac{1}{a^n} \cdot \frac{b^m}{1} = \frac{b^m}{a^n}$.

P.4 RATIONAL EXPONENTS AND RADICALS

1. Using exponential notation we can write $\sqrt[3]{5}$ as $5^{1/3}$.

2. Using radicals we can write $5^{1/2}$ as $\sqrt{5}$.

3. No. $\sqrt{5^2} = (5^2)^{1/2} = 5^{2(1/2)} = 5$ and $(\sqrt{5})^2 = (5^{1/2})^2 = 5^{(1/2)2} = 5$.

4. $(4^{1/2})^3 = 2^3 = 8$; $(4^3)^{1/2} = 64^{1/2} = 8$

5. Because the denominator is of the form \sqrt{a} , we multiply numerator and denominator by \sqrt{a} : $\frac{1}{\sqrt{3}} = \frac{1}{\sqrt{3}} \cdot \frac{\sqrt{3}}{\sqrt{3}} = \frac{\sqrt{3}}{3}$.

6. $5^{1/3} \cdot 5^{2/3} = 5^1 = 5$

7. No. If a is negative, then $\sqrt{4a^2} = -2a$.

8. No. For example, if $a = -2$, then $\sqrt{a^2 + 4} = \sqrt{8} = 2\sqrt{2}$, but $a + 2 = 0$.

9. $\frac{1}{\sqrt{3}} = 3^{-1/2}$

10. $\sqrt[3]{7^2} = 7^{2/3}$

11. $4^{2/3} = \sqrt[3]{4^2} = \sqrt[3]{16}$

12. $10^{-3/2} = (10^{3/2})^{-1} = (\sqrt{10^3})^{-1} = \frac{1}{\sqrt{10^3}}$

13. $\sqrt[5]{5^3} = 5^{3/5}$

14. $2^{-1.5} = 2^{-3/2} = \frac{1}{\sqrt{2^3}} = \frac{1}{\sqrt{8}}$

15. $a^{2/5} = \sqrt[5]{a^2}$

17. $\sqrt[3]{y^4} = y^{4/3}$

19. (a) $\sqrt{16} = \sqrt{4^2} = 4$

(b) $\sqrt[4]{16} = \sqrt[4]{2^4} = 2$

(c) $\sqrt[4]{\frac{1}{16}} = \sqrt[4]{\left(\frac{1}{2}\right)^4} = \frac{1}{2}$

21. (a) $3\sqrt[3]{16} = 3\sqrt[3]{2 \cdot 2^3} = 6\sqrt[3]{2}$

(b) $\frac{\sqrt{18}}{\sqrt{81}} = \sqrt{\frac{18}{81}} = \sqrt{\frac{2}{9}} = \frac{\sqrt{2}}{3}$

(c) $\sqrt{\frac{27}{4}} = \sqrt{\frac{3 \cdot 3^2}{2^2}} = \frac{3\sqrt{3}}{2}$

23. (a) $\sqrt{7}\sqrt{28} = \sqrt{7 \cdot 28} = \sqrt{196} = 14$

(b) $\frac{\sqrt{48}}{\sqrt{3}} = \sqrt{\frac{48}{3}} = \sqrt{16} = 4$

(c) $\sqrt[4]{24}\sqrt[4]{54} = \sqrt[4]{24 \cdot 54} = \sqrt[4]{1296} = 6$

25. (a) $\frac{\sqrt{216}}{\sqrt{6}} = \sqrt{\frac{216}{6}} = \sqrt{36} = 6$

(b) $\sqrt[3]{2}\sqrt[3]{32} = \sqrt[3]{64} = 4$

(c) $\sqrt[4]{\frac{1}{4}}\sqrt[4]{\frac{1}{64}} = \sqrt[4]{\frac{1}{256}} = \frac{1}{\sqrt[4]{256}} = \frac{1}{4}$

27. $\sqrt[4]{x^4} = |x|$

29. $\sqrt[5]{32y^6} = \sqrt[5]{2^5y^6} = 2\sqrt[5]{y^6} = 2y\sqrt[5]{y}$

31. $\sqrt[4]{16x^8} = \sqrt[4]{2^4x^8} = 2x^2$

33. $\sqrt[3]{x^3y} = (x^3)^{1/3}y^{1/3} = x\sqrt[3]{y}$

35. $\sqrt{36r^2t^4} = \sqrt{(6rt^2)^2} = 6|r|t^2$

37. $\sqrt[3]{\sqrt{64x^6}} = (8|x^3|)^{1/3} = 2|x|$

39. $\sqrt{32} + \sqrt{18} = \sqrt{16 \cdot 2} + \sqrt{9 \cdot 2} = \sqrt{4^2 \cdot 2} + \sqrt{3^2 \cdot 2} = 4\sqrt{2} + 3\sqrt{2} = 7\sqrt{2}$

40. $\sqrt{75} + \sqrt{48} = \sqrt{25 \cdot 3} + \sqrt{16 \cdot 3} = \sqrt{5^2 \cdot 3} + \sqrt{4^2 \cdot 3} = 5\sqrt{3} + 4\sqrt{3} = 9\sqrt{3}$

41. $\sqrt{125} - \sqrt{45} = \sqrt{25 \cdot 5} - \sqrt{9 \cdot 5} = \sqrt{5^2 \cdot 5} - \sqrt{3^2 \cdot 5} = 5\sqrt{5} - 3\sqrt{5} = 2\sqrt{5}$

42. $\sqrt[3]{54} - \sqrt[3]{16} = \sqrt[3]{2 \cdot 3^3} - \sqrt[3]{2^3 \cdot 2} = 3\sqrt[3]{2} - 2\sqrt[3]{2} = \sqrt[3]{2}$

43. $\sqrt{9a^3} - \sqrt{a} = \sqrt{3^2a^2 \cdot a} - \sqrt{a} = 3a\sqrt{a} - \sqrt{a} = (3a - 1)\sqrt{a}$

44. $\sqrt{16x} + \sqrt{x^5} = \sqrt{4^2x} + \sqrt{(x^2)^2x} = 4\sqrt{x} + x^2\sqrt{x} = (x^2 + 4)\sqrt{x}$

45. $\sqrt[3]{x^4} + \sqrt[3]{8x} = \sqrt[3]{x^3x} + \sqrt[3]{2^3x} = x\sqrt[3]{x} + 2\sqrt[3]{x} = (x + 2)\sqrt[3]{x}$

46. $\sqrt[3]{2y^4} - \sqrt[3]{2y} = \sqrt[3]{2y \cdot y^3} - \sqrt[3]{2y} = \sqrt[3]{2y}\sqrt[3]{y^3} - \sqrt[3]{2y} = (y - 1)\sqrt[3]{2y}$

16. $\frac{1}{\sqrt{x^5}} = \frac{1}{x^{5/2}} = x^{-5/2}$

18. $y^{-5/3} = \frac{1}{y^{5/3}} = \frac{1}{\sqrt[3]{y^5}}$

20. (a) $\sqrt{64} = \sqrt{8^2} = 8$

(b) $\sqrt[3]{-64} = \sqrt[3]{(-4)^3} = -4$

(c) $\sqrt[5]{-32} = \sqrt[5]{(-2)^5} = -2$

22. (a) $2\sqrt[3]{81} = 2\sqrt[3]{3 \cdot 3^3} = 6\sqrt[3]{3}$

(b) $\frac{\sqrt{12}}{\sqrt{25}} = \frac{\sqrt{3 \cdot 2^2}}{5} = \frac{2\sqrt{3}}{5}$

(c) $\sqrt{\frac{18}{49}} = \sqrt{\frac{2 \cdot 3^2}{7^2}} = \frac{3\sqrt{2}}{7}$

24. (a) $\sqrt{12}\sqrt{24} = \sqrt{12 \cdot 24} = \sqrt{288} = \sqrt{2 \cdot 12^2} = 12\sqrt{2}$

(b) $\frac{\sqrt{54}}{\sqrt{6}} = \sqrt{\frac{54}{6}} = \sqrt{9} = 3$

(c) $\sqrt[3]{15}\sqrt[3]{75} = \sqrt[3]{15 \cdot 75} = \sqrt[3]{1125} = \sqrt[3]{125 \cdot 9} = 5\sqrt[3]{9}$

26. (a) $\sqrt[5]{\frac{1}{8}}\sqrt[5]{\frac{1}{4}} = \sqrt[5]{\frac{1}{32}} = \frac{1}{2}$

(b) $\sqrt[6]{\frac{1}{2}}\sqrt[6]{128} = \sqrt[6]{64} = 2$

(c) $\frac{\sqrt[3]{4}}{\sqrt[3]{108}} = \sqrt[3]{\frac{4}{108}} = \sqrt[3]{\frac{1}{27}} = \frac{1}{\sqrt[3]{27}} = \frac{1}{3}$

28. $\sqrt[5]{x^{10}} = (x^{10})^{1/5} = x^2$

30. $\sqrt[3]{8a^5} = \sqrt[3]{2^3a^3a^2} = 2a\sqrt[3]{a^2}$

32. $\sqrt[3]{x^3y^6} = (x^3y^6)^{1/3} = xy^2$

34. $\sqrt{x^4y^4} = (x^4y^4)^{1/2} = x^2y^2$

36. $\sqrt[4]{48a^7b^4} = \sqrt[4]{2^4a^4b^4 \cdot 3a^3} = 2|ab|\sqrt[4]{3a^3}$

38. $\sqrt[4]{x^4y^2z^2} = \sqrt[4]{x^4}\sqrt[4]{y^2z^2} = |x|\sqrt[4]{y^2z^2}$

$$47. \sqrt{81x^2 + 81} = \sqrt{81(x^2 + 1)} = \sqrt{81}\sqrt{x^2 + 1} = 9\sqrt{x^2 + 1}$$

$$48. \sqrt{36x^2 + 36y^2} = \sqrt{36(x^2 + y^2)} = \sqrt{36}\sqrt{x^2 + y^2} = 6\sqrt{x^2 + y^2}$$

$$49. \text{(a)} 16^{1/4} = 2$$

$$\text{(b)} -125^{1/3} = -5$$

$$\text{(c)} 9^{-1/2} = \frac{1}{9^{1/2}} = \frac{1}{3}$$

$$50. \text{(a)} 27^{1/3} = 3$$

$$\text{(b)} (-8)^{1/3} = -2$$

$$\text{(c)} -\left(\frac{1}{8}\right)^{1/3} = -\frac{1}{2}$$

$$51. \text{(a)} 32^{2/5} = \left(32^{1/5}\right)^2 = 2^2 = 4$$

$$\text{(b)} \left(\frac{4}{9}\right)^{-1/2} = \left(\frac{9}{4}\right)^{1/2} = \frac{3}{2}$$

$$\text{(c)} \left(\frac{16}{81}\right)^{3/4} = \left(\frac{2}{3}\right)^3 = \frac{8}{27}$$

$$52. \text{(a)} 125^{2/3} = 5^2 = 25$$

$$\text{(b)} \left(\frac{25}{64}\right)^{3/2} = \left(\frac{5}{8}\right)^3 = \frac{125}{512}$$

$$\text{(c)} 27^{-4/3} = 3^{-4} = \frac{1}{81}$$

$$53. \text{(a)} 5^{2/3} \cdot 5^{1/3} = 5^{2/3+1/3} = 5^1 = 5$$

$$\text{(b)} \frac{3^{3/5}}{32^{5/5}} = 3^{3/5-2/5} = \sqrt[5]{3}$$

$$\text{(c)} \left(\sqrt[3]{4}\right)^3 = 4^{(1/3)3} = 4$$

$$54. \text{(a)} 3^{2/7} \cdot 3^{12/7} = 3^{2/7+12/7} = 3^2 = 9$$

$$\text{(b)} \frac{7^{2/3}}{7^{5/3}} = 7^{2/3-5/3} = \frac{1}{7}$$

$$\text{(c)} \left(\sqrt[5]{6}\right)^{-10} = 6^{(1/5)(-10)} = \frac{1}{36}$$

$$55. \text{When } x = 3, y = 4, z = -1 \text{ we have } \sqrt{x^2 + y^2} = \sqrt{3^2 + 4^2} = \sqrt{9 + 16} = \sqrt{25} = 5.$$

$$56. \text{When } x = 3, y = 4, z = -1 \text{ we have } \sqrt[4]{x^3 + 14y + 2z} = \sqrt[4]{3^3 + 14(4) + 2(-1)} = \sqrt[4]{27 + 56 - 2} = \sqrt[4]{81} = \sqrt[4]{3^4} = 3.$$

$$57. \text{When } x = 3, y = 4, z = -1 \text{ we have}$$

$$\begin{aligned} (9x)^{2/3} + (2y)^{2/3} + z^{2/3} &= (9 \cdot 3)^{2/3} + (2 \cdot 4)^{2/3} + (-1)^{2/3} = (3^3)^{2/3} + (2^3)^{2/3} + (1)^{1/3} \\ &= 3^2 + 2^2 + 1 = 9 + 4 + 1 = 14. \end{aligned}$$

$$58. \text{When } x = 3, y = 4, z = -1 \text{ we have } (xy)^{2z} = (3 \cdot 4)^{2 \cdot (-1)} = 12^{-2} = \frac{1}{144}.$$

$$59. \text{(a)} x^{3/4}x^{5/4} = x^{3/4+5/4} = x^2$$

$$\text{(b)} y^{2/3}y^{4/3} = y^{2/3+4/3} = y^2$$

$$60. \text{(a)} r^{1/6}r^{5/6} = r^{1/6+5/6} = r$$

$$\text{(b)} a^{3/5}a^{3/10} = a^{3/5+3/10} = a^{9/10}$$

$$61. \text{(a)} \frac{w^{4/3}w^{2/3}}{w^{1/3}} = w^{4/3+2/3-1/3} = w^{5/3}$$

$$\text{(b)} \frac{a^{5/4} \left(2a^{3/4}\right)^3}{a^{1/4}} = 2^3 a^{(5/2)+(3/4)3-1/4} = 8a^{13/4}$$

$$62. \text{(a)} \frac{x^{3/4}x^{7/4}}{x^{5/4}} = x^{3/4+7/4-5/4} = x^{5/4}$$

$$\text{(b)} \frac{\left(2y^{4/3}\right)^2 y^{-2/3}}{y^{7/3}} = 4y^{8/3-2/3-7/3} = 4y^{-1/3} = \frac{4}{\sqrt[3]{y}}$$

$$63. \text{(a)} \left(8a^6b^{3/2}\right)^{2/3} = 8^{2/3}a^{6(2/3)}b^{(3/2)(2/3)} = 4a^4b$$

$$\text{(b)} (4a^6b^8)^{3/2} = 4^{3/2}a^{6(3/2)}b^{8(3/2)} = 8a^9b^{12}$$

$$64. \text{(a)} \left(64a^6b^3\right)^{2/3} = 64^{2/3}a^{6(2/3)}b^{3(2/3)} = 16a^4b^2$$

$$\text{(b)} \left(16w^8z^{3/2}\right)^{3/4} = 16^{3/4}w^{8(3/4)}z^{(3/2)(3/4)} = 8w^6z^{9/8}$$

$$65. \text{(a)} \left(8y^3\right)^{-2/3} = 8^{-2/3}y^{3(-2/3)} = \frac{1}{4y^2}$$

$$\text{(b)} \left(u^4v^6\right)^{-1/3} = u^{4(-1/3)}v^{6(-1/3)} = \frac{1}{u^{4/3}v^2}$$

$$66. \text{(a)} \left(x^{-5}y^{1/3}\right)^{-3/5} = x^{-5(-3/5)}y^{(1/3)(-3/5)} = \frac{x^3}{y^{1/5}}$$

$$\text{(b)} \left(4r^8t^{-1/2}\right)^{1/2} \left(32t^{-5/4}\right)^{-1/5} = 4^{1/2}r^{8(1/2)}t^{(-1/2)(1/2)} (32)^{-1/5} t^{(-5/4)(-1/5)} = 2r^4t^{-1/4} \left(\frac{1}{2}\right)t^{1/4} = r^4t^0 = r^4$$

$$67. \text{(a)} \left(\frac{x^{-2/3}}{y^{1/2}}\right) \left(\frac{x^{-2}}{y^{-3}}\right)^{1/6} = x^{-2/3+(-2)(1/6)}y^{-1/2-(-3)(1/6)} = \frac{1}{x}$$

- (b) $\left(\frac{x^{1/2}y^2}{2y^{1/4}}\right)^4 \left(\frac{4x^{-2}y^{-4}}{y^2}\right)^{1/2} = x^{(1/2)(4)}y^{2(4)}2^{-1(4)}y^{(-1/4)(4)}4^{1/2}x^{-2(1/2)}y^{-4(1/2)}y^{-2(1/2)}$
 $= x^2y^82^{-4}y^{-1}2x^{-1}y^{-2}y^{-1} = 2^{-4+1}x^{2-1}y^{8-1-2-1} = \frac{xy^4}{8}$
68. (a) $\left(\frac{x^8y^{-4}}{16y^{4/3}}\right)^{-1/4} = 16^{-(-1/4)}x^{8(-1/4)}y^{-4(-1/4)-4/3(-1/4)} = \frac{2y^{4/3}}{x^2}$
 (b) $\left(\frac{-8y^{3/4}}{y^3z^6}\right)^{-1/3} = (-8)^{-1/3}y^{3/4(-1/3)-3(-1/3)}z^{-6(-1/3)} = \frac{-y^{3/4}z^2}{2}$
69. $\sqrt{x^3} = x^{3/2}$
 70. $\sqrt{x^5} = x^{5/2}$
71. $\sqrt[9]{x^5} = x^{5/9}$
 72. $\frac{1}{\sqrt[5]{x^3}} = \frac{1}{x^{3/5}} = x^{-3/5}$
73. $\left(\sqrt[6]{y^5}\right)\left(\sqrt[3]{y^2}\right) = y^{5/6} \cdot y^{2/3} = y^{5/6+2/3} = y^{3/2}$
 74. $\sqrt[4]{b^3}\sqrt{b} = b^{3/4+1/2} = b^{5/4}$
75. $(5\sqrt[3]{x})(2\sqrt[4]{x}) = 5 \cdot 2x^{1/3+1/4} = 10x^{7/12}$
 76. $(2\sqrt{a})\left(\sqrt[3]{a^2}\right) = 2a^{1/2+2/3} = 2a^{7/6}$
77. $\frac{\sqrt[4]{x^7}}{\sqrt[4]{x^3}} = \sqrt[4]{x^4} = x$
 78. $\frac{\sqrt[3]{8x^2}}{\sqrt{x}} = 2x^{2/3} \cdot x^{-1/2} = 2x^{1/6} = 2\sqrt[6]{x}$
79. $\sqrt{\frac{16u^3v}{uv^5}} = \sqrt{\frac{16u^2}{v^4}} = \frac{4u}{v^2}$
 80. $\sqrt[3]{\frac{54x^2y^4}{2x^5y}} = \sqrt[3]{\frac{27y^3}{x^3}} = \frac{3y}{x}$
81. $\frac{\sqrt{xy}}{\sqrt[4]{16xy}} = 16^{-1/4}x^{1/2-1/4}y^{1/2-1/4} = \frac{x^{1/4}y^{1/4}}{2}$
 82. $\frac{\sqrt{a^3b}}{\sqrt[4]{a^3b^2}} = a^{3/2-3/4}b^{1/2-2/4} = a^{3/4}b^{1/4}$
83. $\sqrt[3]{y\sqrt{y}} = \left(y^{1+1/2}\right)^{1/3} = y^{(3/2)(1/3)} = y^{1/2}$
 84. $\sqrt{s\sqrt{s^3}} = \left(s^{1+3/2}\right)^{1/2} = s^{5/4}$
85. (a) $\frac{1}{\sqrt{6}} = \frac{1}{\sqrt{6}} \cdot \frac{\sqrt{6}}{\sqrt{6}} = \frac{\sqrt{6}}{6}$
 (b) $\sqrt{\frac{3}{2}} = \frac{\sqrt{3}}{\sqrt{2}} \cdot \frac{\sqrt{2}}{\sqrt{2}} = \frac{\sqrt{6}}{2}$
 (c) $\frac{9}{\sqrt[4]{2}} = \frac{9}{2^{1/4}} \cdot \frac{2^{3/4}}{2^{3/4}} = \frac{9\sqrt[4]{8}}{2}$
86. (a) $\frac{12}{\sqrt{3}} = \frac{12}{\sqrt{3}} \cdot \frac{\sqrt{3}}{\sqrt{3}} = \frac{12\sqrt{3}}{3} = 4\sqrt{3}$
 (b) $\sqrt{\frac{12}{5}} = \frac{\sqrt{12}}{\sqrt{5}} \cdot \frac{\sqrt{5}}{\sqrt{5}} = \frac{\sqrt{60}}{5} = \frac{2\sqrt{15}}{5}$
 (c) $\frac{8}{\sqrt[3]{5^2}} = \frac{8}{5^{2/3}} \cdot \frac{5^{1/3}}{5^{1/3}} = \frac{8\sqrt[3]{5}}{5}$
87. (a) $\frac{1}{\sqrt{5x}} = \frac{1}{\sqrt{5x}} \cdot \frac{\sqrt{5x}}{\sqrt{5x}} = \frac{\sqrt{5x}}{5x}$
 (b) $\sqrt{\frac{x}{5}} = \frac{\sqrt{x}}{\sqrt{5}} \cdot \frac{\sqrt{5}}{\sqrt{5}} = \frac{\sqrt{5x}}{5}$
 (c) $\sqrt[5]{\frac{1}{x^3}} = \frac{1}{x^{3/5}} \cdot \frac{x^{2/5}}{x^{2/5}} = \frac{x^{2/5}}{x}$
88. (a) $\sqrt{\frac{s}{3t}} = \frac{\sqrt{s}}{\sqrt{3t}} \cdot \frac{\sqrt{3t}}{\sqrt{3t}} = \frac{\sqrt{3st}}{3t}$
 (b) $\frac{a}{\sqrt[6]{b^2}} = \frac{a}{b^{1/3}} \cdot \frac{b^{2/3}}{b^{2/3}} = \frac{ab^{2/3}}{b}$
 (c) $\frac{1}{c^{3/5}} = \frac{1}{c^{3/5}} \cdot \frac{c^{2/5}}{c^{2/5}} = \frac{c^{2/5}}{c}$
89. (a) $\frac{1}{\sqrt[3]{x}} = \frac{1}{\sqrt[3]{x}} \cdot \frac{\sqrt[3]{x^2}}{\sqrt[3]{x^2}} = \frac{\sqrt[3]{x^2}}{x}$
 (b) $\frac{1}{\sqrt[6]{x^5}} = \frac{1}{\sqrt[6]{x^5}} \cdot \frac{\sqrt[6]{x}}{\sqrt[6]{x}} = \frac{\sqrt[6]{x}}{x}$
 (c) $\frac{1}{\sqrt[7]{x^3}} = \frac{1}{\sqrt[7]{x^3}} \cdot \frac{\sqrt[7]{x^4}}{\sqrt[7]{x^4}} = \frac{\sqrt[7]{x^4}}{x}$
90. (a) $\frac{1}{\sqrt[3]{x^2}} = \frac{1}{\sqrt[3]{x^2}} \cdot \frac{\sqrt[3]{x}}{\sqrt[3]{x}} = \frac{\sqrt[3]{x}}{x}$
 (b) $\frac{1}{\sqrt[4]{x^3}} = \frac{1}{\sqrt[4]{x^3}} \cdot \frac{\sqrt[4]{x}}{\sqrt[4]{x}} = \frac{\sqrt[4]{x}}{x}$
 (c) $\frac{1}{\sqrt[3]{x^4}} = \frac{1}{\sqrt[3]{x^3} \cdot x} = \frac{1}{x\sqrt[3]{x}} = \frac{1}{x\sqrt[3]{x}} \cdot \frac{\sqrt[3]{x^2}}{\sqrt[3]{x^2}} = \frac{\sqrt[3]{x^2}}{x\sqrt[3]{x^3}} = \frac{\sqrt[3]{x^2}}{x^2}$

91. (a) Since $\frac{1}{2} > \frac{1}{3}$, $2^{1/2} > 2^{1/3}$.
 (b) $\left(\frac{1}{2}\right)^{1/2} = 2^{-1/2}$ and $\left(\frac{1}{2}\right)^{1/3} = 2^{-1/3}$. Since $-\frac{1}{2} < -\frac{1}{3}$, we have $\left(\frac{1}{2}\right)^{1/2} < \left(\frac{1}{2}\right)^{1/3}$.
92. (a) We find a common root: $7^{1/4} = 7^{3/12} = (7^3)^{1/12} = 343^{1/12}$; $4^{1/3} = 4^{4/12} = (4^4)^{1/12} = 256^{1/12}$. So $7^{1/4} > 4^{1/3}$.
 (b) We find a common root: $\sqrt[3]{5} = 5^{1/3} = 5^{2/6} = (5^2)^{1/6} = 25^{1/6}$; $\sqrt{3} = 3^{1/2} = 3^{3/6} = (3^3)^{1/6} = 27^{1/6}$. So $\sqrt[3]{5} < \sqrt{3}$.
93. First convert 1135 feet to miles. This gives $1135 \text{ ft} = 1135 \cdot \frac{1 \text{ mile}}{5280 \text{ feet}} = 0.215 \text{ mi}$. Thus the distance you can see is given by $D = \sqrt{2rh + h^2} = \sqrt{2(3960)(0.215) + (0.215)^2} \approx \sqrt{1702.8} \approx 41.3$ miles.
94. (a) Using $f = 0.4$ and substituting $d = 65$, we obtain $s = \sqrt{30fd} = \sqrt{30 \times 0.4 \times 65} \approx 28$ mi/h.
 (b) Using $f = 0.5$ and substituting $s = 50$, we find d . This gives $s = \sqrt{30fd} \Leftrightarrow 50 = \sqrt{30 \cdot (0.5)d} \Leftrightarrow 50 = \sqrt{15d} \Leftrightarrow 2500 = 15d \Leftrightarrow d = \frac{500}{3} \approx 167$ feet.
95. (a) Substituting, we get $0.30(60) + 0.38(3400)^{1/2} - 3(650)^{1/3} \approx 18 + 0.38(58.31) - 3(8.66) \approx 18 + 22.16 - 25.98 \approx 14.18$. Since this value is less than 16, the sailboat qualifies for the race.
 (b) Solve for A when $L = 65$ and $V = 600$. Substituting, we get $0.30(65) + 0.38A^{1/2} - 3(600)^{1/3} \leq 16 \Leftrightarrow 19.5 + 0.38A^{1/2} - 25.30 \leq 16 \Leftrightarrow 0.38A^{1/2} - 5.80 \leq 16 \Leftrightarrow 0.38A^{1/2} \leq 21.80 \Leftrightarrow A^{1/2} \leq 57.38 \Leftrightarrow A \leq 3292.0$. Thus, the largest possible sail is 3292 ft^2 .
96. (a) Substituting the given values we get $V = 1.486 \frac{75^{2/3} \cdot 0.050^{1/2}}{24.1^{2/3} \cdot 0.040} \approx 17.707$ ft/s.
 (b) Since the volume of the flow is $V \cdot A$, the canal discharge is $17.707 \cdot 75 \approx 1328.0$ ft³/s.

97. (a)

n	1	2	5	10	100
$2^{1/n}$	$2^{1/1} = 2$	$2^{1/2} = 1.414$	$2^{1/5} = 1.149$	$2^{1/10} = 1.072$	$2^{1/100} = 1.007$

So when n gets large, $2^{1/n}$ decreases toward 1.

(b)

n	1	2	5	10	100
$\left(\frac{1}{2}\right)^{1/n}$	$\left(\frac{1}{2}\right)^{1/1} = 0.5$	$\left(\frac{1}{2}\right)^{1/2} = 0.707$	$\left(\frac{1}{2}\right)^{1/5} = 0.871$	$\left(\frac{1}{2}\right)^{1/10} = 0.933$	$\left(\frac{1}{2}\right)^{1/100} = 0.993$

So when n gets large, $\left(\frac{1}{2}\right)^{1/n}$ increases toward 1.

P.5 ALGEBRAIC EXPRESSIONS

1. (a) $2x^3 - \frac{1}{2}x + \sqrt{3}$ is a polynomial. (The constant term is not an integer, but all exponents are integers.)
 (b) $x^2 - \frac{1}{2} - 3\sqrt{x} = x^2 - \frac{1}{2} - 3x^{1/2}$ is not a polynomial because the exponent $\frac{1}{2}$ is not an integer.
 (c) $\frac{1}{x^2 + 4x + 7}$ is not a polynomial. (It is the reciprocal of the polynomial $x^2 + 4x + 7$.)
 (d) $x^5 + 7x^2 - x + 100$ is a polynomial.
 (e) $\sqrt[3]{8x^6 - 5x^3 + 7x - 3}$ is not a polynomial. (It is the cube root of the polynomial $8x^6 - 5x^3 + 7x - 3$.)
 (f) $\sqrt{3}x^4 + \sqrt{5}x^2 - 15x$ is a polynomial. (Some coefficients are not integers, but all exponents are integers.)

2. To add polynomials we add *like* terms. So

$$(3x^2 + 2x + 4) + (8x^2 - x + 1) = (3 + 8)x^2 + (2 - 1)x + (4 + 1) = 11x^2 + x + 5.$$

3. To subtract polynomials we subtract *like* terms. So

$$(2x^3 + 9x^2 + x + 10) - (x^3 + x^2 + 6x + 8) = (2 - 1)x^3 + (9 - 1)x^2 + (1 - 6)x + (10 - 8) = x^3 + 8x^2 - 5x + 2.$$

4. We use FOIL to multiply two polynomials: $(x + 2)(x + 3) = x \cdot x + x \cdot 3 + 2 \cdot x + 2 \cdot 3 = x^2 + 5x + 6$.

5. The Special Product Formula for the “square of a sum” is $(A + B)^2 = A^2 + 2AB + B^2$. So

$$(2x + 3)^2 = (2x)^2 + 2(2x)(3) + 3^2 = 4x^2 + 12x + 9.$$

6. The Special Product Formula for the “product of the sum and difference of terms” is $(A + B)(A - B) = A^2 - B^2$. So

$$(5 + x)(5 - x) = 5^2 - x^2 = 25 - x^2.$$

7. (a) No, $(x + 5)^2 = x^2 + 10x + 25 \neq x^2 + 25$.

(b) Yes, if $a \neq 0$, then $(x + a)^2 = x^2 + 2ax + a^2$.

8. (a) Yes, $(x + 5)(x - 5) = x^2 + 5x - 5x - 25 = x^2 - 25$.

(b) Yes, if $a \neq 0$, then $(x + a)(x - a) = x^2 + ax - ax + a^2 = x^2 + a^2$.

9. Binomial, terms $5x^3$ and 6, degree 3

10. Trinomial, terms $-2x^2$, $5x$, and -3 , degree 2

11. Monomial, term -8 , degree 0

12. Monomial, term $\frac{1}{2}x^7$, degree 7

13. Four terms, terms x , $-x^2$, x^3 , and $-x^4$, degree 4

14. Binomial, terms $\sqrt{2}x$ and $-\sqrt{3}$, degree 1

15. $(6x - 3) + (3x + 7) = (6x + 3x) + (-3 + 7) = 9x + 4$

16. $(3 - 7x) - (11 + 4x) = (-7x - 4x) + (3 - 11) = -11x - 8$

17. $(2x^2 - 5x) - (x^2 - 8x + 3) = (2x^2 - x^2) + [-5x - (-8x)] + (-3) = x^2 + 3x - 3$

18. $(-2x^2 - 3x + 1) + (3x^2 + 5x - 4) = (-2x^2 + 3x^2) + (-3x + 5x) + (1 - 4) = x^2 + 2x - 3$

19. $3(x - 1) + 4(x + 2) = 3x - 3 + 4x + 8 = 7x + 5$

20. $8(2x + 5) - 7(x - 9) = 16x + 40 - 7x + 63 = 9x + 103$

21. $(5x^3 + 4x^2 - 3x) - (x^2 + 7x + 2) = 5x^3 + (4x^2 - x^2) + (-3x - 7x) - 2 = 5x^3 + 3x^2 - 10x - 2$

22. $4(x^2 - 3x + 5) - 3(x^2 - 2x + 1) = 4x^2 - 12x + 20 - 3x^2 + 6x - 3 = x^2 - 6x + 17$

23. $2x(x - 1) = 2x^2 - 2x$

24. $3y(2y + 5) = 6y^2 + 15y$

25. $x^2(x + 3) = x^3 + 3x^2$

26. $-y(y^2 - 2) = -y^3 + 2y$

27. $2(2 - 5t) + t(t + 10) = 4 - 10t + t^2 + 10t = t^2 + 4$

28. $5(3t - 4) - 2t(t - 3) = -2t^2 + 21t - 20$

29. $r(r^2 - 9) + 3r^2(2r - 1) = r^3 - 9r + 6r^3 - 3r^2 = 7r^3 - 3r^2 - 9r$

30. $v^3(v - 9) - 2v^2(2 - 2v) = v^4 - 5v^3 - 4v^2$

31. $x^2(2x^2 - x + 1) = 2x^4 - x^3 + x^2$

32. $3x^3(x^4 - 4x^2 + 5) = 3x^7 - 12x^5 + 15x^3$

33. $(x - 3)(x + 5) = x^2 + 5x - 3x - 15 = x^2 + 2x - 15$

34. $(4 + x)(2 + x) = 8 + 4x + 2x + x^2 = x^2 + 6x + 8$

35. $(s + 6)(2s + 3) = 2s^2 + 3s + 12s + 18 = 2s^2 + 15s + 18$

36. $(2t + 3)(t - 1) = 2t^2 - 2t + 3t - 3 = 2t^2 + t - 3$

37. $(3t - 2)(7t - 4) = 21t^2 - 12t - 14t + 8 = 21t^2 - 26t + 8$

38. $(4s - 1)(2s + 5) = 8s^2 + 18s - 5$

39. $(3x + 5)(2x - 1) = 6x^2 + 10x - 3x - 5 = 6x^2 + 7x - 5$

40. $(7y - 3)(2y - 1) = 14y^2 - 13y + 3$

41. $(x + 3y)(2x - y) = 2x^2 + 5xy - 3y^2$

43. $(2r - 5s)(3r - 2s) = 6r^2 - 19rs + 10s^2$

45. $(5x + 1)^2 = 25x^2 + 10x + 1$

47. $(3y - 1)^2 = (3y)^2 - 2(3y)(1) + 1^2 = 9y^2 - 6y + 1$

49. $(2u + v)^2 = 4u^2 + 4uv + v^2$

51. $(2x + 3y)^2 = 4x^2 + 12xy + 9y^2$

53. $(x^2 + 1)^2 = x^4 + 2x^2 + 1$

55. $(x + 6)(x - 6) = x^2 - 36$

57. $(3x - 4)(3x + 4) = (3x)^2 - 4^2 = 9x^2 - 16$

59. $(x + 3y)(x - 3y) = x^2 - (3y)^2 = x^2 - 9y^2$

61. $(\sqrt{x} + 2)(\sqrt{x} - 2) = x - 4$

63. $(y + 2)^3 = y^3 + 3y^2(2) + 3y(2^2) + 2^3 = y^3 + 6y^2 + 12y + 8$

64. $(x - 3)^3 = x^3 - 3x^2(3) + 3x(-3)^2 - 3^3 = x^3 - 9x^2 + 27x - 27$

65. $(1 - 2r)^3 = 1^3 - 3(1^2)(2r) + 3(1)(2r)^2 - (2r)^3 = -8r^3 + 12r^2 - 6r + 1$

66. $(3 + 2y)^3 = 3^3 + 3(3^2)(2y) + 3(3)(2y)^2 + (2y)^3 = 8y^3 + 36y^2 + 54y + 27$

67. $(x + 2)(x^2 + 2x + 3) = x^3 + 2x^2 + 3x + 2x^2 + 4x + 6 = x^3 + 4x^2 + 7x + 6$

68. $(x + 1)(2x^2 - x + 1) = 2x^3 - x^2 + x + 2x^2 - x + 1 = 2x^3 + x^2 + 1$

69. $(2x - 5)(x^2 - x + 1) = 2x^3 - 2x^2 + 2x - 5x^2 + 5x - 5 = 2x^3 - 7x^2 + 7x - 5$

70. $(1 + 2x)(x^2 - 3x + 1) = x^2 - 3x + 1 + 2x^3 - 6x^2 + 2x = 2x^3 - 5x^2 - x + 1$

71. $\sqrt{x}(x - \sqrt{x}) = x\sqrt{x} - (\sqrt{x})^2 = x\sqrt{x} - x$

72. $x^{3/2}(\sqrt{x} - 1/\sqrt{x}) = x^2 - x$

73. $y^{1/3}(y^{2/3} + y^{5/3}) = y^{1/3+2/3} + y^{1/3+5/3} = y^2 + y$

74. $x^{1/4}(2x^{3/4} - x^{1/4}) = 2x - \sqrt{x}$

75. $(x^2 + y^2)^2 = (x^2)^2 + (y^2)^2 + 2x^2y^2 = x^4 + y^4 + 2x^2y^2$

76. $\left(c + \frac{1}{c}\right)^2 = \frac{1}{c^2} + c^2 + 2$

77. $(x^2 - a^2)(x^2 + a^2) = x^4 - a^4$

78. $(x^{1/2} + y^{1/2})(x^{1/2} - y^{1/2}) = x - y$

79. $(\sqrt{a} - b)(\sqrt{a} + b) = a - b^2$

80. $(\sqrt{h^2 + 1} + 1)(\sqrt{h^2 + 1} - 1) = h^2$

81. $(1 + x^{2/3})(1 - x^{2/3}) = 1 - x^{4/3}$

82. $(1 - b)^2(1 + b)^2 = b^4 - 2b^2 + 1$

83. $((x - 1) + x^2)((x - 1) - x^2) = (x - 1)^2 - (x^2)^2 = x^2 - 2x + 1 - x^4 = -x^4 + x^2 - 2x + 1$

84. $(x + (2 + x^2))(x - (2 + x^2)) = -x^4 - 3x^2 - 4$

85. $(2x + y - 3)(2x + y + 3) = (2x + y)^2 - 3^2 = 4x^2 + 4xy + y^2 - 9$

42. $(4x - 5y)(3x - y) = 12x^2 - 19xy + 5y^2$

44. $(6u + 5v)(u - 2v) = 6u^2 - 7uv - 10v^2$

46. $(2 - 7y)^2 = 49y^2 - 28y + 4$

48. $(2y + 5)^2 = (2y)^2 + 2(2y)(5) + 5^2 = 4y^2 + 20y + 25$

50. $(x - 3y)^2 = x^2 - 6xy + 9y^2$

52. $(r - 2s)^2 = r^2 - 4rs + 4s^2$

54. $(2 + y^3)^2 = y^6 + 4y^3 + 4$

56. $(5 - y)(5 + y) = 25 - y^2$

58. $(2y + 5)(2y - 5) = 4y^2 - 25$

60. $(2u + v)(2u - v) = 4u^2 - v^2$

62. $(\sqrt{y} + \sqrt{2})(\sqrt{y} - \sqrt{2}) = y - 2$

86. $(x + y + z)(x - y - z) = x^2 - y^2 - z^2 - 2yz$

87. (a) $\text{RHS} = \frac{1}{2}[(a + b)^2 - (a^2 + b^2)] = \frac{1}{2}[(a^2 + b^2 + 2ab) - a^2 - b^2] = \frac{1}{2}(2ab) = ab = \text{LHS}$

(b) $\text{LHS} = (a^2 + b^2)^2 - (a^2 - b^2)^2 = (a^2)^2 + (b^2)^2 + 2a^2b^2 - [(a^2)^2 + (b^2)^2 - 2a^2b^2] = 4a^2b^2 = \text{RHS}$

88. $\text{LHS} = (a^2 + b^2)(c^2 + d^2) = a^2c^2 + a^2d^2 + b^2c^2 + b^2d^2$

$= (a^2c^2 + b^2d^2 + 2abcd) + (a^2d^2 + b^2c^2 - 2abcd) = (ac + bd)^2 + (ad - bc)^2 = \text{RHS}$

89. (a) The height of the box is x , its width is $6 - 2x$, and its length is $10 - 2x$. Since $\text{Volume} = \text{height} \times \text{width} \times \text{length}$, we have $V = x(6 - 2x)(10 - 2x)$.

(b) $V = x(60 - 32x + 4x^2) = 60x - 32x^2 + 4x^3$, degree 3.

(c) When $x = 1$, the volume is $V = 60(1) - 32(1^2) + 4(1^3) = 32$, and when $x = 2$, the volume is

$V = 60(2) - 32(2^2) + 4(2^3) = 24$.

90. (a) The width is the width of the lot minus the setbacks of 10 feet each. Thus $\text{width} = x - 20$ and $\text{length} = y - 20$. Since $\text{Area} = \text{width} \times \text{length}$, we get $A = (x - 20)(y - 20)$.

(b) $A = (x - 20)(y - 20) = xy - 20x - 20y + 400$

(c) For the 100×400 lot, the building envelope has $A = (100 - 20)(400 - 20) = 80(380) = 30,400$. For the 200×200 , lot the building envelope has $A = (200 - 20)(200 - 20) = 180(180) = 32,400$. The 200×200 lot has a larger building envelope.

91. (a) $A = 2000(1 + r)^3 = 2000(1 + 3r + 3r^2 + r^3) = 2000 + 6000r + 6000r^2 + 2000r^3$, degree 3.

(b) Remember that % means divide by 100, so $2\% = 0.02$.

Interest rate r	2%	3%	4.5%	6%	10%
Amount A	\$2122.42	\$2185.45	\$2282.33	\$2382.03	\$2662.00

92. (a) $P = R - C = (50x - 0.05x^2) - (50 + 30x - 0.1x^2) = 50x - 0.05x^2 - 50 - 30x + 0.1x^2 = 0.05x^2 + 20x - 50$.

(b) The profit on 10 calculators is $P = 0.05(10^2) + 20(10) - 50 = \155 . The profit on 20 calculators is

$P = 0.05(20^2) + 20(20) - 50 = \370 .

93. (a) When $x = 1$, $(x + 5)^2 = (1 + 5)^2 = 36$ and $x^2 + 25 = 1^2 + 25 = 26$.

(b) $(x + 5)^2 = x^2 + 10x + 25$

94. (a) The degree of the product is the sum of the degrees of the original polynomials.

(b) The degree of the sum could be lower than either of the degrees of the original polynomials, but is at most the largest of the degrees of the original polynomials.

(c) Product: $(2x^3 + x - 3)(-2x^3 - x + 7) = -4x^6 - 2x^4 + 14x^3 - 2x^4 - x^2 + 7x + 6x^3 + 3x - 21$
 $= -4x^6 - 4x^4 + 20x^3 - x^2 + 10x - 21$

Sum: $(2x^3 + x - 3) + (-2x^3 - x + 7) = 4$.

P.6 FACTORING

- The polynomial $2x^5 + 6x^4 + 4x^3$ has three terms: $2x^5$, $6x^4$, and $4x^3$.
- The factor $2x^3$ is common to each term, so $2x^5 + 6x^4 + 4x^3 = 2x^3(x^2 + 3x + 2)$.
[In fact, the polynomial can be factored further as $2x^3(x + 2)(x + 1)$.]
- To factor the trinomial $x^2 + 7x + 10$ we look for two integers whose product is 10 and whose sum is 7. These integers are 5 and 2, so the trinomial factors as $(x + 5)(x + 2)$.
- The greatest common factor in the expression $4(x + 1)^2 - x(x + 1)^2$ is $(x + 1)^2$, and the expression factors as $4(x + 1)^2 - x(x + 1)^2 = (x + 1)^2(4 - x)$.
- The Special Factoring Formula for the “difference of squares” is $A^2 - B^2 = (A - B)(A + B)$. So $4x^2 - 25 = (2x - 5)(2x + 5)$.
- The Special Factoring Formula for a “perfect square” is $A^2 + 2AB + B^2 = (A + B)^2$. So $x^2 + 10x + 25 = (x + 5)^2$.
- $5a - 20 = 5(a - 4)$
- $-3b + 12 = -3(b - 4) = 3(-b + 4)$
- $-2x^3 + x = -x(2x^2 - 1)$
- $3x^4 - 6x^3 - x^2 = x^2(3x^2 - 6x - 1)$
- $2x^2y - 6xy^2 + 3xy = xy(2x - 6y + 3)$
- $-7x^4y^2 + 14xy^3 + 21xy^4 = 7xy^2(-x^3 + 2y + 3y^2)$
- $y(y - 6) + 9(y - 6) = (y - 6)(y + 9)$
- $(z + 2)^2 - 5(z + 2) = (z + 2)[(z + 2) - 5] = (z + 2)(z - 3)$
- $x^2 + 8x + 7 = (x + 7)(x + 1)$
- $x^2 + 4x - 5 = (x + 5)(x - 1)$
- $x^2 + 2x - 15 = (x + 5)(x - 3)$
- $2x^2 - 5x - 7 = (x + 1)(2x - 7)$
- $3x^2 - 16x + 5 = (3x - 1)(x - 5)$
- $5x^2 - 7x - 6 = (5x + 3)(x - 2)$
- $(3x + 2)^2 + 8(3x + 2) + 12 = [(3x + 2) + 2][(3x + 2) + 6] = (3x + 4)(3x + 8)$
- $2(a + b)^2 + 5(a + b) - 3 = [(a + b) + 3][2(a + b) - 1] = (a + b + 3)(2a + 2b - 1)$
- $x^2 - 25 = (x - 5)(x + 5)$
- $9 - y^2 = (3 - y)(3 + y)$
- $49 - 4z^2 = (7 - 2z)(7 + 2z)$
- $9a^2 - 16 = (3a - 4)(3a + 4)$
- $16y^2 - z^2 = (4y - z)(4y + z)$
- $a^2 - 36b^2 = (a - 6b)(a + 6b)$
- $(x + 3)^2 - y^2 = [(x + 3) - y][(x + 3) + y] = (x - y + 3)(x + y + 3)$
- $x^2 - (y + 5)^2 = [x + (y + 5)][x - (y + 5)] = (x + y + 5)(x - y - 5)$
- $x^2 + 10x + 25 = (x + 5)^2$
- $9 + 6y + y^2 = (3 + y)^2$
- $z^2 - 12z + 36 = (z - 6)^2$
- $w^2 - 16w + 64 = (w - 8)^2$
- $4t^2 - 20t + 25 = (2t - 5)^2$
- $16a^2 + 24a + 9 = (4a + 3)^2$
- $9u^2 - 6uv + v^2 = (3u - v)^2$
- $x^2 + 10xy + 25y^2 = (x + 5y)^2$
- $x^3 + 27 = (x + 3)(x^2 - 3x + 9)$
- $y^3 - 64 = (y - 4)(y^2 + 4y + 16)$

41. $8a^3 - 1 = (2a - 1)(4a^2 + 2a + 1)$

42. $8 + 27w^3 = (2 + 3w)(4 - 6w + 9w^2)$

43. $27x^3 + y^3 = (3x + y)(9x^2 - 3xy + y^2)$

44. $1 + 1000y^3 = (1 + 10y)(1 - 10y + 100y^2)$

45. $u^3 - v^6 = u^3 - (v^2)^3 = (u - v^2)(u^2 + uv^2 + v^4)$

46. $8r^3 - 64t^6 = (2r - 4t^2)(4r^2 + 8rt^2 + 16t^4)$

47. $x^3 + 4x^2 + x + 4 = x^2(x + 4) + 1(x + 4) = (x + 4)(x^2 + 1)$

48. $3x^3 - x^2 + 6x - 2 = x^2(3x - 1) + 2(3x - 1) = (3x - 1)(x^2 + 2)$

49. $5x^3 + x^2 + 5x + 1 = x^2(5x + 1) + (5x + 1) = (x^2 + 1)(5x + 1)$

50. $18x^3 + 9x^2 + 2x + 1 = 9x^2(2x + 1) + (2x + 1) = (9x^2 + 1)(2x + 1)$

51. $x^3 + x^2 + x + 1 = x^2(x + 1) + 1(x + 1) = (x + 1)(x^2 + 1)$

52. $x^5 + x^4 + x + 1 = x^4(x + 1) + 1(x + 1) = (x + 1)(x^4 + 1)$

53. $x^{5/2} - x^{1/2} = x^{1/2}(x^2 - 1) = \sqrt{x}(x - 1)(x + 1)$

54. $3x^{-1/2} + 4x^{1/2} + x^{3/2} = x^{-1/2}(3 + 4x + x^2) = \left(\frac{1}{\sqrt{x}}\right)(3 + x)(1 + x)$

55. Start by factoring out the power of x with the smallest exponent, that is, $x^{-3/2}$. So

$$x^{-3/2} + 2x^{-1/2} + x^{1/2} = x^{-3/2}(1 + 2x + x^2) = \frac{(1 + x)^2}{x^{3/2}}.$$

56. $(x - 1)^{7/2} - (x - 1)^{3/2} = (x - 1)^{3/2}[(x - 1)^2 - 1] = (x - 1)^{3/2}[(x - 1) - 1][(x - 1) + 1]$
 $= (x - 1)^{3/2}(x - 2)(x)$

57. Start by factoring out the power of $(x^2 + 1)$ with the smallest exponent, that is, $(x^2 + 1)^{-1/2}$. So

$$(x^2 + 1)^{1/2} + 2(x^2 + 1)^{-1/2} = (x^2 + 1)^{-1/2}[(x^2 + 1) + 2] = \frac{x^2 + 3}{\sqrt{x^2 + 1}}.$$

58. $x^{-1/2}(x + 1)^{1/2} + x^{1/2}(x + 1)^{-1/2} = x^{-1/2}(x + 1)^{-1/2}[(x + 1) + x] = \frac{2x + 1}{\sqrt{x}\sqrt{x + 1}}$

59. $2x^{1/3}(x - 2)^{2/3} - 5x^{4/3}(x - 2)^{-1/3} = x^{1/3}(x - 2)^{-1/3}[2(x - 2) - 5x] = x^{1/3}(x - 2)^{-1/3}(2x - 4 - 5x)$
 $= x^{1/3}(x - 2)^{-1/3}(-3x - 4) = \frac{(-3x - 4)\sqrt[3]{x}}{\sqrt[3]{x - 2}}$

60. $3x^{-1/2}(x^2 + 1)^{5/4} - x^{3/2}(x^2 + 1)^{1/4} = x^{-1/2}(x^2 + 1)^{1/4}[3(x^2 + 1) - x^2(1)]$
 $= x^{-1/2}(x^2 + 1)^{1/4}(3x^2 + 3 - x^2) = x^{-1/2}(x^2 + 1)^{1/4}(2x^2 + 3) = \frac{\sqrt[4]{x^2 + 1}(2x^2 + 3)}{\sqrt{x}}$

61. $12x^3 + 18x = 6x(2x^2 + 3)$

62. $30x^3 + 15x^4 = 15x^3(2 + x)$

63. $6y^4 - 15y^3 = 3y^3(2y - 5)$

64. $5ab - 8abc = ab(5 - 8c)$

65. $x^2 - 2x - 8 = (x - 4)(x + 2)$

66. $x^2 - 14x + 48 = (x - 8)(x - 6)$

67. $y^2 - 8y + 15 = (y - 3)(y - 5)$

68. $z^2 + 6z - 16 = (z - 2)(z + 8)$

69. $2x^2 + 5x + 3 = (2x + 3)(x + 1)$

70. $2x^2 + 7x - 4 = (2x - 1)(x + 4)$

71. $9x^2 - 36x - 45 = 9(x^2 - 4x - 5) = 9(x - 5)(x + 1)$

72. $8x^2 + 10x + 3 = (4x + 3)(2x + 1)$

73. $6x^2 - 5x - 6 = (3x + 2)(2x - 3)$

74. $6 + 5t - 6t^2 = (3 - 2t)(2 + 3t)$

75. $x^2 - 36 = (x - 6)(x + 6)$

76. $4x^2 - 25 = (2x - 5)(2x + 5)$

77. $49 - 4y^2 = (7 - 2y)(7 + 2y)$

78. $4t^2 - 9s^2 = (2t - 3s)(2t + 3s)$

79. $t^2 - 6t + 9 = (t - 3)^2$

80. $x^2 + 10x + 25 = (x + 5)^2$

81. $4x^2 + 4xy + y^2 = (2x + y)^2$

82. $r^2 - 6rs + 9s^2 = (r - 3s)^2$

83. $t^3 + 1 = (t + 1)(t^2 - t + 1)$

84. $x^3 - 27 = x^3 - 3^3 = (x - 3)(x^2 + 3x + 9)$

85. $8x^3 - 125 = (2x)^3 - 5^3 = (2x - 5)[(2x)^2 + (2x)(5) + 5^2] = (2x - 5)(4x^2 + 10x + 25)$

86. $125 + 27y^3 = 5^3 + (3y)^3 = (5 + 3y)[5^2 - 5(3y) + (3y)^2] = (3y + 5)(9y^2 - 15y + 25)$

87. $x^3 + 2x^2 + x = x(x^2 + 2x + 1) = x(x + 1)^2$

88. $3x^3 - 27x = 3x(x^2 - 9) = 3x(x - 3)(x + 3)$

89. $x^4 + 2x^3 - 3x^2 = x^2(x^2 + 2x - 3) = x^2(x - 1)(x + 3)$

90. $3w^5 - 5w^4 - 2w^3 = w^3(3w^2 - 5w - 2) = w^3(3w + 1)(w - 2)$

91. $x^4y^3 - x^2y^5 = x^2y^3(x^2 - y^2) = x^2y^3(x + y)(x - y)$

92. $18y^3x^2 - 2xy^4 = 2xy^3(9x - y)$

93. $x^6 - 8y^3 = (x^2)^3 - (2y)^3 = (x^2 - 2y)[(x^2)^2 + (x^2)(2y) + (2y)^2] = (x^2 - 2y)(x^4 + 2x^2y + 4y^2)$

94. $27a^3 + b^6 = (3a)^3 + (b^2)^3 = (3a + b^2)[(3a)^2 - (3a)(b^2) + (b^2)^2] = (3a + b^2)(9a^2 - 3ab^2 + b^4)$

95. $y^3 - 3y^2 - 4y + 12 = (y^3 - 3y^2) + (-4y + 12) = y^2(y - 3) + (-4)(y - 3) = (y - 3)(y^2 - 4) = (y - 3)(y - 2)(y + 2)$
(factor by grouping)

96. $y^3 - y^2 + y - 1 = y^2(y - 1) + 1(y - 1) = (y^2 + 1)(y - 1)$

97. $3x^3 - x^2 - 12x + 4 = 3x^3 - 12x - x^2 + 4 = 3x(x^2 - 4) - (x^2 - 4) = (3x - 1)(x^2 - 4) = (3x - 1)(x - 2)(x + 2)$
(factor by grouping)

98. $9x^3 + 18x^2 - x - 2 = 9x^2(x + 2) - (x + 2) = (9x^2 - 1)(x + 2) = (3x + 1)(3x - 1)(x + 2)$

99. $(a + b)^2 - (a - b)^2 = [(a + b) - (a - b)][(a + b) + (a - b)] = (2b)(2a) = 4ab$

$$100. \left(1 + \frac{1}{x}\right)^2 - \left(1 - \frac{1}{x}\right)^2 = \left[\left(1 + \frac{1}{x}\right) - \left(1 - \frac{1}{x}\right)\right] \left[\left(1 + \frac{1}{x}\right) + \left(1 - \frac{1}{x}\right)\right] \\ = \left(1 + \frac{1}{x} - 1 + \frac{1}{x}\right) \left(1 + \frac{1}{x} + 1 - \frac{1}{x}\right) = \left(\frac{2}{x}\right) (2) = \frac{4}{x}$$

$$101. x^2(x^2 - 1) - 9(x^2 - 1) = (x^2 - 1)(x^2 - 9) = (x - 1)(x + 1)(x - 3)(x + 3)$$

$$102. (a^2 - 1)b^2 - 4(a^2 - 1) = (a^2 - 1)(b^2 - 4) = (a - 1)(a + 1)(b - 2)(b + 2)$$

$$103. (x - 1)(x + 2)^2 - (x - 1)^2(x + 2) = (x - 1)(x + 2)[(x + 2) - (x - 1)] = 3(x - 1)(x + 2)$$

$$104. (x + 1)^3x - 2(x + 1)^2x^2 + x^3(x + 1) = x(x + 1)[(x + 1)^2 - 2(x + 1)x + x^2] = x(x + 1)[(x + 1) - x]^2 \\ = x(x + 1)(1)^2 = x(x + 1)$$

$$105. y^4(y + 2)^3 + y^5(y + 2)^4 = y^4(y + 2)^3[(1) + y(y + 2)] = y^4(y + 2)^3(y^2 + 2y + 1) = y^4(y + 2)^3(y + 1)^2$$

$$106. n(x - y) + (n - 1)(y - x) = n(x - y) - (n - 1)(x - y) = (x - y)[n - (n - 1)] = x - y$$

107. Start by factoring $y^2 - 7y + 10$, and then substitute $a^2 + 1$ for y . This gives

$$(a^2 + 1)^2 - 7(a^2 + 1) + 10 = [(a^2 + 1) - 2][(a^2 + 1) - 5] = (a^2 - 1)(a^2 - 4) = (a - 1)(a + 1)(a - 2)(a + 2)$$

$$108. (a^2 + 2a)^2 - 2(a^2 + 2a) - 3 = [(a^2 + 2a) - 3][(a^2 + 2a) + 1] = (a^2 + 2a - 3)(a^2 + 2a + 1) \\ = (a - 1)(a + 3)(a + 1)^2$$

$$109. 3x^2(4x - 12)^2 + x^3(2)(4x - 12)(4) = x^2(4x - 12)[3(4x - 12) + x(2)(4)] = 4x^2(x - 3)(12x - 36 + 8x) \\ = 4x^2(x - 3)(20x - 36) = 16x^2(x - 3)(5x - 9)$$

$$110. 5(x^2 + 4)^4(2x)(x - 2)^4 + (x^2 + 4)^5(4)(x - 2)^3 = 2(x^2 + 4)^4(x - 2)^3[(5)(x)(x - 2) + (x^2 + 4)(2)] \\ = 2(x^2 + 4)^4(x - 2)^3(5x^2 - 10x + 2x^2 + 8) = 2(x^2 + 4)^4(x - 2)^3(7x^2 - 10x + 8)$$

$$111. 3(2x - 1)^2(2)(x + 3)^{1/2} + (2x - 1)^3\left(\frac{1}{2}\right)(x + 3)^{-1/2} = (2x - 1)^2(x + 3)^{-1/2}[6(x + 3) + (2x - 1)\left(\frac{1}{2}\right)] \\ = (2x - 1)^2(x + 3)^{-1/2}\left(6x + 18 + x - \frac{1}{2}\right) = (2x - 1)^2(x + 3)^{-1/2}\left(7x + \frac{35}{2}\right)$$

$$112. \frac{1}{3}(x + 6)^{-2/3}(2x - 3)^2 + (x + 6)^{1/3}(2)(2x - 3)(2) = \frac{1}{3}(x + 6)^{-2/3}(2x - 3)[(2x - 3) + (3)(x + 6)(4)] \\ = \frac{1}{3}(x + 6)^{-2/3}(2x - 3)[2x - 3 + 12x + 72] = \frac{1}{3}(x + 6)^{-2/3}(2x - 3)(14x + 69)$$

$$113. (x^2 + 3)^{-1/3} - \frac{2}{3}x^2(x^2 + 3)^{-4/3} = (x^2 + 3)^{-4/3}\left[(x^2 + 3) - \frac{2}{3}x^2\right] = (x^2 + 3)^{-4/3}\left(\frac{1}{3}x^2 + 3\right) = \frac{\frac{1}{3}x^2 + 3}{(x^2 + 3)^{4/3}}$$

$$114. \frac{1}{2}x^{-1/2}(3x + 4)^{1/2} + \frac{3}{2}x^{1/2}(3x + 4)^{-1/2} = \frac{1}{2}x^{-1/2}(3x + 4)^{-1/2}[(3x + 4) + 3x] = \frac{1}{2}x^{-1/2}(3x + 4)^{-1/2}(6x + 4) \\ = x^{-1/2}(3x + 4)^{-1/2}(3x + 2)$$

- 115.** The volume of the shell is the difference between the volumes of the outside cylinder (with radius R) and the inside cylinder (with radius r). Thus $V = \pi R^2 h - \pi r^2 h = \pi (R^2 - r^2) h = \pi (R - r)(R + r) h = 2\pi \cdot \frac{R + r}{2} \cdot h \cdot (R - r)$. The average radius is $\frac{R + r}{2}$ and $2\pi \cdot \frac{R + r}{2}$ is the average circumference (length of the rectangular box), h is the height, and $R - r$ is the thickness of the rectangular box. Thus $V = \pi R^2 h - \pi r^2 h = 2\pi \cdot \frac{R + r}{2} \cdot h \cdot (R - r) = 2\pi \cdot (\text{average radius}) \cdot (\text{height}) \cdot (\text{thickness})$

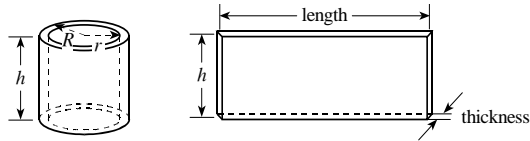

- 116. (a)** Mowed portion = field - habitat
(b) Using the difference of squares, we get $b^2 - (b - 2x)^2 = [b - (b - 2x)][b + (b - x)] = 2x(2b - 2x) = 4x(b - x)$.
- 117. (a)** $528^2 - 527^2 = (528 - 527)(528 + 527) = 1(1055) = 1055$
(b) $122^2 - 120^2 = (122 - 120)(122 + 120) = 2(242) = 484$
(c) $1020^2 - 1010^2 = (1020 - 1010)(1020 + 1010) = 10(2030) = 20,300$
- 118. (a)** $501 \cdot 499 = (500 + 1)(500 - 1) = 500^2 - 1 = 250,000 - 1 = 249,999$
(b) $79 \cdot 61 = (70 + 9)(70 - 9) = 70^2 - 9^2 = 4900 - 81 = 4819$
(c) $2007 \cdot 1993 = (2000 + 7)(2000 - 7) = 2000^2 - 7^2 = 4,000,000 - 49 = 3,999,951$
- 119. (a)** $A^4 - B^4 = (A^2 - B^2)(A^2 + B^2) = (A - B)(A + B)(A^2 + B^2)$
 $A^6 - B^6 = (A^3 - B^3)(A^3 + B^3)$ (difference of squares)
 $= (A - B)(A^2 + AB + B^2)(A + B)(A^2 - AB + B^2)$ (difference and sum of cubes)
(b) $12^4 - 7^4 = 20,736 - 2,401 = 18,335$; $12^6 - 7^6 = 2,985,984 - 117,649 = 2,868,335$
(c) $18,335 = 12^4 - 7^4 = (12 - 7)(12 + 7)(12^2 + 7^2) = 5(19)(144 + 49) = 5(19)(193)$
 $2,868,335 = 12^6 - 7^6 = (12 - 7)(12 + 7)[12^2 + 12(7) + 7^2][12^2 - 12(7) + 7^2]$
 $= 5(19)(144 + 84 + 49)(144 - 84 + 49) = 5(19)(277)(109)$
- 120. (a)** $(A - 1)(A + 1) = A^2 + A - A - 1 = A^2 - 1$
 $(A - 1)(A^2 + A + 1) = A^3 + A^2 + A - A^2 - A - 1 = A^3 - 1$
 $(A - 1)(A^3 + A^2 + A + 1) = A^4 + A^3 + A^2 + A - A^3 - A^2 - A - 1$
(b) We conjecture that $A^5 - 1 = (A - 1)(A^4 + A^3 + A^2 + A + 1)$. Expanding the right-hand side, we have
 $(A - 1)(A^4 + A^3 + A^2 + A + 1) = A^5 + A^4 + A^3 + A^2 + A - A^4 - A^3 - A^2 - A - 1 = A^5 - 1$, verifying our conjecture. Generally, $A^n - 1 = (A - 1)(A^{n-1} + A^{n-2} + \cdots + A + 1)$ for any positive integer n .

$$\begin{array}{r}
 121. \text{ (a)} \\
 \begin{array}{r}
 A + 1 \\
 \times \quad A - 1 \\
 \hline
 -A - 1 \\
 A^2 + A \\
 \hline
 A^2 - 1
 \end{array}
 \qquad
 \begin{array}{r}
 A^2 + A + 1 \\
 \times \quad A - 1 \\
 \hline
 -A^2 - A - 1 \\
 A^3 + A^2 + A \\
 \hline
 A^3 - 1
 \end{array}
 \qquad
 \begin{array}{r}
 A^3 + A^2 + A + 1 \\
 \times \quad A - 1 \\
 \hline
 -A^3 - A^2 - A - 1 \\
 A^4 + A^3 + A^2 + A \\
 \hline
 A^4 - 1
 \end{array}
 \end{array}$$

(b) Based on the pattern in part (a), we suspect that $A^5 - 1 = (A - 1)(A^4 + A^3 + A^2 + A + 1)$. Check:

$$\begin{array}{r}
 A^4 + A^3 + A^2 + A + 1 \\
 \times \quad A - 1 \\
 \hline
 -A^4 - A^3 - A^2 - A - 1 \\
 A^5 + A^4 + A^3 + A^2 + A \\
 \hline
 A^5 - 1
 \end{array}$$

The general pattern is $A^n - 1 = (A - 1)(A^{n-1} + A^{n-2} + \cdots + A^2 + A + 1)$, where n is a positive integer.

P.7 RATIONAL EXPRESSIONS

- (a) $\frac{3x}{x^2 - 1}$ is a rational expression.

(b) $\frac{\sqrt{x+1}}{2x+3}$ is not a rational expression. A rational expression must be a polynomial divided by a polynomial, and the numerator of the expression is $\sqrt{x+1}$, which is not a polynomial.

(c) $\frac{x(x^2 - 1)}{x + 3} = \frac{x^3 - x}{x + 3}$ is a rational expression.
- To simplify a rational expression we cancel factors that are common to the *numerator* and *denominator*. So, the expression $\frac{(x+1)(x+2)}{(x+3)(x+2)}$ simplifies to $\frac{x+1}{x+3}$.
- To multiply two rational expressions we multiply their *numerators* together and multiply their *denominators* together. So $\frac{2}{x+1} \cdot \frac{x}{x+3}$ is the same as $\frac{2 \cdot x}{(x+1) \cdot (x+3)} = \frac{2x}{x^2 + 4x + 3}$.
- (a) $\frac{1}{x} - \frac{2}{(x+1)} - \frac{x}{(x+1)^2}$ has three terms.

(b) The least common denominator of all the terms is $x(x+1)^2$.

(c) $\frac{1}{x} - \frac{2}{(x+1)} - \frac{x}{(x+1)^2} = \frac{(x+1)^2}{x(x+1)^2} - \frac{2x(x+1)}{(x+1)^2} - \frac{x(x)}{(x+1)^2} = \frac{(x+1)^2 - 2x(x+1) - x^2}{x(x+1)^2}$
 $= \frac{x^2 + 2x + 1 - 2x^2 - 2x - x^2}{x(x+1)^2} = \frac{-2x^2 + 1}{x(x+1)^2}$
- (a) Yes. Cancelling $x+1$, we have $\frac{x(x+1)}{(x+1)^2} = \frac{x}{x+1}$.

(b) No; $(x+5)^2 = x^2 + 10x + 25 \neq x^2 + 25$, so $x+5 = \sqrt{x^2 + 10x + 25} \neq \sqrt{x^2 + 25}$.
- (a) Yes, $\frac{3+a}{3} = \frac{3}{3} + \frac{a}{3} = 1 + \frac{a}{3}$.

(b) No. We cannot “separate” the denominator in this way; only the numerator, as in part (a). (See also Exercise 101.)
- The domain of $4x^2 - 10x + 3$ is all real numbers.
- The domain of $-x^4 + x^3 + 9x$ is all real numbers.

9. Since $x - 3 \neq 0$ we have $x \neq 3$. Domain: $\{x \mid x \neq 3\}$
10. Since $3t + 6 \neq 0$ we have $t \neq -2$. Domain: $\{t \mid t \neq -2\}$
11. Since $x + 3 \geq 0$, $x \geq -3$. Domain: $\{x \mid x \geq -3\}$
12. Since $x - 1 > 0$, $x > 1$. Domain: $\{x \mid x > 1\}$
13. $x^2 - x - 2 = (x + 1)(x - 2) \neq 0 \Leftrightarrow x \neq -1$ or 2 , so the domain is $\{x \mid x \neq -1, 2\}$.
14. $2x \geq 0$ and $x + 1 \neq 0 \Leftrightarrow x \geq 0$ and $x \neq -1$, so the domain is $\{x \mid x \geq 0\}$.
15. $\frac{5(x-3)(2x+1)}{10(x-3)^2} = \frac{5(x-3)(2x+1)}{5(x-3) \cdot 2(x-3)} = \frac{2x+1}{2(x-3)}$
16. $\frac{4(x^2-1)}{12(x+2)(x-1)} = \frac{4(x+1)(x-1)}{12(x+2)(x-1)} = \frac{x+1}{3(x+2)}$
17. $\frac{x-2}{x^2-4} = \frac{x-2}{(x-2)(x+2)} = \frac{1}{x+2}$
18. $\frac{x^2-x-2}{x^2-1} = \frac{(x-2)(x+1)}{(x-1)(x+1)} = \frac{x-2}{x-1}$
19. $\frac{x^2+5x+6}{x^2+8x+15} = \frac{(x+2)(x+3)}{(x+5)(x+3)} = \frac{x+2}{x+5}$
20. $\frac{x^2-x-12}{x^2+5x+6} = \frac{(x-4)(x+3)}{(x+2)(x+3)} = \frac{x-4}{x+2}$
21. $\frac{y^2+y}{y^2-1} = \frac{y(y+1)}{(y-1)(y+1)} = \frac{y}{y-1}$
22. $\frac{y^2-3y-18}{2y^2+7y+3} = \frac{(y-6)(y+3)}{(2y+1)(y+3)} = \frac{y-6}{2y+1}$
23. $\frac{2x^3-x^2-6x}{2x^2-7x+6} = \frac{x(2x^2-x-6)}{(2x-3)(x-2)} = \frac{x(2x+3)(x-2)}{(2x-3)(x-2)} = \frac{x(2x+3)}{2x-3}$
24. $\frac{1-x^2}{x^3-1} = \frac{(1-x)(1+x)}{(x-1)(x^2+x+1)} = \frac{-(x-1)(1+x)}{(x-1)(x^2+x+1)} = \frac{-(x+1)}{x^2+x+1}$
25. $\frac{4x}{x^2-4} \cdot \frac{x+2}{16x} = \frac{4x}{(x-2)(x+2)} \cdot \frac{x+2}{16x} = \frac{1}{4(x-2)}$
26. $\frac{x^2-25}{x^2-16} \cdot \frac{x+4}{x+5} = \frac{(x-5)(x+5)}{(x-4)(x+4)} \cdot \frac{x+4}{x+5} = \frac{x-5}{x-4}$
27. $\frac{x^2+2x-15}{x^2-25} \cdot \frac{x-5}{x+2} = \frac{(x+5)(x-3)(x-5)}{(x+5)(x-5)(x+2)} = \frac{x-3}{x+2}$
28. $\frac{x^2+2x-3}{x^2-2x-3} \cdot \frac{3-x}{3+x} = \frac{(x+3)(x-1)}{(x-3)(x+1)} \cdot \frac{-(x-3)}{x+3} = \frac{-(x-1)}{x+1} = \frac{-x+1}{x+1} = \frac{1-x}{1+x}$
29. $\frac{t-3}{t^2+9} \cdot \frac{t+3}{t^2-9} = \frac{(t-3)(t+3)}{(t^2+9)(t-3)(t+3)} = \frac{1}{t^2+9}$
30. $\frac{x^2-x-6}{x^2+2x} \cdot \frac{x^3+x^2}{x^2-2x-3} = \frac{(x-3)(x+2)}{x(x+2)} \cdot \frac{x^2(x+1)}{(x-3)(x+1)} = x$
31. $\frac{x^2+7x+12}{x^2+3x+2} \cdot \frac{x^2+5x+6}{x^2+6x+9} = \frac{(x+3)(x+4)}{(x+1)(x+2)} \cdot \frac{(x+2)(x+3)}{(x+3)(x+3)} = \frac{x+4}{x+1}$
32. $\frac{x^2+2xy+y^2}{x^2-y^2} \cdot \frac{2x^2-xy-y^2}{x^2-xy-2y^2} = \frac{(x+y)(x+y)}{(x-y)(x+y)} \cdot \frac{(x-y)(2x+y)}{(x-2y)(x+y)} = \frac{2x+y}{x-2y}$
33. $\frac{x+3}{4x^2-9} \div \frac{x^2+7x+12}{2x^2+7x-15} = \frac{x+3}{4x^2-9} \cdot \frac{2x^2+7x-15}{x^2+7x+12} = \frac{x+3}{(2x-3)(2x+3)} \cdot \frac{(x+5)(2x-3)}{(x+3)(x+4)} = \frac{x+5}{(2x+3)(x+4)}$
34. $\frac{2x+1}{2x^2+x-15} \div \frac{6x^2-x-2}{x+3} = \frac{2x+1}{(x+3)(2x-5)} \cdot \frac{x+3}{(2x+1)(3x-2)} = \frac{1}{(2x-5)(3x-2)}$
35. $\frac{\frac{x^3}{x+1}}{\frac{x}{x^2+2x+1}} = \frac{x^3}{x+1} \cdot \frac{x^2+2x+1}{x} = \frac{x^3(x+1)(x+1)}{(x+1)x} = x^2(x+1)$
36. $\frac{\frac{2x^2-3x-2}{x^2-1}}{\frac{2x^2+5x+2}{x^2+x-2}} = \frac{2x^2-3x-2}{x^2-1} \cdot \frac{x^2+x-2}{2x^2+5x+2} = \frac{(x-2)(2x+1)}{(x-1)(x+1)} \cdot \frac{(x-1)(x+2)}{(x+2)(2x+1)} = \frac{x-2}{x+1}$

37. $\frac{x/y}{z} = \frac{x}{y} \cdot \frac{1}{z} = \frac{x}{yz}$
38. $\frac{x}{y/z} = x \div \frac{y}{z} = \frac{x}{1} \cdot \frac{z}{y} = \frac{xz}{y}$
39. $1 + \frac{1}{x+3} = \frac{x+3}{x+3} + \frac{1}{x+3} = \frac{x+4}{x+3}$
40. $\frac{3x-2}{x+1} - 2 = \frac{3x-2}{x+1} - \frac{2(x+1)}{x+1} = \frac{3x-2-2x-2}{x+1} = \frac{x-4}{x+1}$
41. $\frac{1}{x+5} + \frac{2}{x-3} = \frac{x-3}{(x+5)(x-3)} + \frac{2(x+5)}{(x+5)(x-3)} = \frac{x-3+2x+10}{(x+5)(x-3)} = \frac{3x+7}{(x+5)(x-3)}$
42. $\frac{1}{x+1} + \frac{1}{x-1} = \frac{x-1}{(x+1)(x-1)} + \frac{x+1}{(x+1)(x-1)} = \frac{x-1+x+1}{(x+1)(x-1)} = \frac{2x}{(x+1)(x-1)}$
43. $\frac{3}{x+1} - \frac{1}{x+2} = \frac{3(x+2)}{(x+1)(x+2)} - \frac{x+1}{(x+1)(x+2)} = \frac{3x+6-x-1}{(x+1)(x+2)} = \frac{2x+5}{(x+1)(x+2)}$
44. $\frac{x}{x-4} - \frac{3}{x+6} = \frac{x(x+6)}{(x-4)(x+6)} + \frac{-3(x-4)}{(x-4)(x+6)} = \frac{x^2+6x-3x+12}{(x-4)(x+6)} = \frac{x^2+3x+12}{(x-4)(x+6)}$
45. $\frac{5}{2x-3} - \frac{3}{(2x-3)^2} = \frac{5(2x-3)}{(2x-3)^2} - \frac{3}{(2x-3)^2} = \frac{10x-15-3}{(2x-3)^2} = \frac{10x-18}{(2x-3)^2} = \frac{2(5x-9)}{(2x-3)^2}$
46. $\frac{x}{(x+1)^2} + \frac{2}{x+1} = \frac{x}{(x+1)^2} + \frac{2(x+1)}{(x+1)(x+1)} = \frac{x+2x+2}{(x+1)^2} = \frac{3x+2}{(x+1)^2}$
47. $u+1 + \frac{u}{u+1} = \frac{(u+1)(u+1)}{u+1} + \frac{u}{u+1} = \frac{u^2+2u+1+u}{u+1} = \frac{u^2+3u+1}{u+1}$
48. $\frac{2}{a^2} - \frac{3}{ab} + \frac{4}{b^2} = \frac{2b^2}{a^2b^2} - \frac{3ab}{a^2b^2} + \frac{4a^2}{a^2b^2} = \frac{2b^2-3ab+4a^2}{a^2b^2}$
49. $\frac{1}{x^2} + \frac{1}{x^2+x} = \frac{1}{x^2} + \frac{1}{x(x+1)} = \frac{x+1}{x^2(x+1)} + \frac{x}{x^2(x+1)} = \frac{2x+1}{x^2(x+1)}$
50. $\frac{1}{x} + \frac{1}{x^2} + \frac{1}{x^3} = \frac{x^2}{x^3} + \frac{x}{x^3} + \frac{1}{x^3} = \frac{x^2+x+1}{x^3}$
51. $\frac{2}{x+3} - \frac{1}{x^2+7x+12} = \frac{2}{x+3} - \frac{1}{(x+3)(x+4)} = \frac{2(x+4)}{(x+3)(x+4)} + \frac{-1}{(x+3)(x+4)}$
 $= \frac{2x+8-1}{(x+3)(x+4)} = \frac{2x+7}{(x+3)(x+4)}$
52. $\frac{x}{x^2-4} + \frac{1}{x-2} = \frac{x}{(x-2)(x+2)} + \frac{1}{x-2} = \frac{x}{(x-2)(x+2)} + \frac{x+2}{(x-2)(x+2)}$
 $= \frac{2x+2}{(x-2)(x+2)} = \frac{2(x+1)}{(x-2)(x+2)}$
53. $\frac{1}{x+3} + \frac{1}{x^2-9} = \frac{1}{x+3} + \frac{1}{(x-3)(x+3)} = \frac{x-3}{(x-3)(x+3)} + \frac{1}{(x-3)(x+3)} = \frac{x-2}{(x-3)(x+3)}$
54. $\frac{x}{x^2+x-2} - \frac{2}{x^2-5x+4} = \frac{x}{(x-1)(x+2)} + \frac{-2}{(x-1)(x-4)}$
 $= \frac{x(x-4)}{(x-1)(x+2)(x-4)} + \frac{-2(x+2)}{(x-1)(x+2)(x-4)} = \frac{x^2-4x-2x-4}{(x-1)(x+2)(x-4)} = \frac{x^2-6x-4}{(x-1)(x+2)(x-4)}$
55. $\frac{2}{x} + \frac{3}{x-1} - \frac{4}{x^2-x} = \frac{2}{x} + \frac{3}{x-1} - \frac{4}{x(x-1)} = \frac{2(x-1)}{x(x-1)} + \frac{3x}{x(x-1)} + \frac{-4}{x(x-1)} = \frac{2x-2+3x-4}{x(x-1)} = \frac{5x-6}{x(x-1)}$
56. $\frac{x}{x^2-x-6} - \frac{1}{x+2} - \frac{2}{x-3} = \frac{x}{(x-3)(x+2)} + \frac{-1}{x+2} + \frac{-2}{x-3}$
 $= \frac{x}{(x-3)(x+2)} + \frac{-1(x-3)}{(x-3)(x+2)} + \frac{-2(x+2)}{(x-3)(x+2)} = \frac{x-x+3-2x-4}{(x-3)(x+2)} = \frac{-2x-1}{(x-3)(x+2)}$

$$57. \frac{1}{x^2 + 3x + 2} - \frac{1}{x^2 - 2x - 3} = \frac{1}{(x+2)(x+1)} - \frac{1}{(x-3)(x+1)}$$

$$= \frac{x-3}{(x-3)(x+2)(x+1)} + \frac{-1}{(x-3)(x+2)(x+1)} = \frac{x-3-x-2}{(x-3)(x+2)(x+1)} = \frac{-5}{(x-3)(x+2)(x+1)}$$

$$58. \frac{1}{x+1} - \frac{2}{(x+1)^2} + \frac{3}{x^2-1} = \frac{1}{x+1} + \frac{-2}{(x+1)^2} + \frac{3}{(x-1)(x+1)}$$

$$= \frac{(x+1)(x-1)}{(x-1)(x+1)^2} + \frac{-2(x-1)}{(x-1)(x+1)^2} + \frac{3(x+1)}{(x-1)(x+1)^2}$$

$$= \frac{x^2-1}{(x-1)(x+1)^2} + \frac{-2x+2}{(x-1)(x+1)^2} + \frac{3x+3}{(x-1)(x+1)^2} = \frac{x^2-1-2x+2+3x+3}{(x-1)(x+1)^2} = \frac{x^2+x+4}{(x-1)(x+1)^2}$$

$$59. \frac{1 + \frac{1}{x}}{\frac{1}{x} - 2} = \frac{x\left(1 + \frac{1}{x}\right)}{x\left(\frac{1}{x} - 2\right)} = \frac{x+1}{1-2x}$$

$$60. \frac{1 - \frac{2}{y}}{\frac{3}{y} - 1} = \frac{y\left(1 - \frac{2}{y}\right)}{y\left(\frac{3}{y} - 1\right)} = \frac{y-2}{3-y}$$

$$61. \frac{1 + \frac{1}{x+2}}{1 - \frac{1}{x+2}} = \frac{(x+2)\left(1 + \frac{1}{x+2}\right)}{(x+2)\left(1 - \frac{1}{x+2}\right)} = \frac{(x+2)+1}{(x+2)-1} = \frac{x+3}{x+1}$$

$$62. \frac{1 + \frac{1}{c-1}}{1 - \frac{1}{c-1}} = \frac{c-1+1}{c-1-1} = \frac{c}{c-2}$$

$$63. \frac{\frac{1}{x-1} + \frac{1}{x+3}}{x+1} = \frac{(x-1)(x+3)\left(\frac{1}{x-1} + \frac{1}{x+3}\right)}{(x-1)(x+3)(x+1)} = \frac{(x+3) + (x-1)}{(x-1)(x+1)(x+3)} = \frac{2(x+1)}{(x-1)(x+1)(x+3)}$$

$$= \frac{2}{(x-1)(x+3)}$$

$$64. \frac{\frac{x-3}{x-4} - \frac{x+2}{x+1}}{x+3} = \frac{(x-3)(x+1) - (x+2)(x-4)}{(x-4)(x+3)(x+1)} = \frac{x^2-2x-3 - (x^2-2x-8)}{(x-4)(x+3)(x+1)} = \frac{5}{(x-4)(x+3)(x+1)}$$

$$65. \frac{x - \frac{x}{y}}{y - \frac{y}{x}} = \frac{xy\left(x - \frac{x}{y}\right)}{xy\left(y - \frac{y}{x}\right)} = \frac{x^2y - x^2}{xy^2 - y^2} = \frac{x^2(y-1)}{y^2(x-1)}$$

$$66. \frac{x + \frac{y}{x}}{y + \frac{x}{y}} = \frac{xy\left(x + \frac{y}{x}\right)}{xy\left(y + \frac{x}{y}\right)} = \frac{x^2y + y^2}{xy^2 + x^2} = \frac{y(y+x^2)}{x(x+y^2)}$$

$$67. \frac{\frac{x}{y} - \frac{y}{x}}{\frac{1}{x^2} - \frac{1}{y^2}} = \frac{\frac{x^2-y^2}{xy}}{\frac{y^2-x^2}{x^2y^2}} = \frac{x^2-y^2}{xy} \cdot \frac{x^2y^2}{y^2-x^2} = \frac{xy}{-1} = -xy. \text{ An alternative method is to multiply the}$$

numerator and denominator by the common denominator of both the numerator and denominator, in this case x^2y^2 :

$$\frac{\frac{x}{y} - \frac{y}{x}}{\frac{1}{x^2} - \frac{1}{y^2}} = \frac{\left(\frac{x}{y} - \frac{y}{x}\right) \cdot x^2y^2}{\left(\frac{1}{x^2} - \frac{1}{y^2}\right) \cdot x^2y^2} = \frac{x^3y - xy^3}{y^2 - x^2} = \frac{xy(x^2 - y^2)}{y^2 - x^2} = -xy.$$

$$68. x - \frac{y}{\frac{x}{y} + \frac{y}{x}} = x - \frac{y}{\frac{x}{y} + \frac{y}{x}} \cdot \frac{xy}{xy} = x - \frac{xy^2}{x^2 + y^2} = \frac{x(x^2 + y^2)}{x^2 + y^2} - \frac{xy^2}{x^2 + y^2} = \frac{x^3 + xy^2 - xy^2}{x^2 + y^2} = \frac{x^3}{x^2 + y^2}$$

$$69. \frac{x^{-2} - y^{-2}}{x^{-1} + y^{-1}} = \frac{\frac{1}{x^2} - \frac{1}{y^2}}{\frac{1}{x} + \frac{1}{y}} = \frac{\frac{y^2}{x^2 y^2} - \frac{x^2}{x^2 y^2}}{\frac{y}{xy} + \frac{x}{xy}} = \frac{y^2 - x^2}{x^2 y^2} \cdot \frac{xy}{y + x} = \frac{(y - x)(y + x)xy}{x^2 y^2 (y + x)} = \frac{y - x}{xy}$$

Alternatively, $\frac{x^{-2} - y^{-2}}{x^{-1} + y^{-1}} = \frac{\left(\frac{1}{x^2} - \frac{1}{y^2}\right)}{\left(\frac{1}{x} + \frac{1}{y}\right)} \cdot \frac{x^2 y^2}{x^2 y^2} = \frac{y^2 - x^2}{xy^2 + x^2 y} = \frac{(y - x)(y + x)}{xy(y + x)} = \frac{y - x}{xy}$.

$$70. \frac{x^{-1} + y^{-1}}{(x + y)^{-1}} = \frac{\frac{1}{x} + \frac{1}{y}}{\frac{1}{x + y}} = \frac{\frac{1}{x} + \frac{1}{y}}{\frac{1}{x + y}} \cdot \frac{xy(x + y)}{xy(x + y)} = \frac{y(x + y) + x(x + y)}{xy} \\ = \frac{xy + y^2 + x^2 + xy}{xy} = \frac{x^2 + 2xy + y^2}{xy} = \frac{(x + y)^2}{xy}$$

$$71. 1 - \frac{1}{1 - \frac{1}{x}} = 1 - \frac{x}{x - 1} = \frac{x - 1 - x}{x - 1} = \frac{1}{1 - x}$$

$$72. 1 + \frac{1}{1 + \frac{1}{1 + x}} = 1 + \frac{1 + x}{(1 + x) + 1} = 1 + \frac{x + 1}{x + 2} = \frac{x + 2 + x + 1}{x + 2} = \frac{2x + 3}{x + 2}$$

$$73. \frac{\frac{1}{1 + x + h} - \frac{1}{1 + x}}{h} = \frac{(1 + x) - (1 + x + h)}{h(1 + x)(1 + x + h)} = -\frac{1}{(1 + x)(1 + x + h)}$$

74. In calculus it is necessary to eliminate the h in the denominator, and we do this by rationalizing the numerator:

$$\frac{\frac{1}{\sqrt{x+h}} - \frac{1}{\sqrt{x}}}{h} = \frac{\sqrt{x} - \sqrt{x+h}}{h\sqrt{x}\sqrt{x+h}} \cdot \frac{\sqrt{x} + \sqrt{x+h}}{\sqrt{x} + \sqrt{x+h}} = \frac{x - (x+h)}{h\sqrt{x}\sqrt{x+h}(\sqrt{x} + \sqrt{x+h})} = -\frac{1}{\sqrt{x}\sqrt{x+h}(\sqrt{x} + \sqrt{x+h})}$$

$$75. \frac{\frac{1}{(x+h)^2} - \frac{1}{x^2}}{h} = \frac{x^2 - (x+h)^2}{hx^2(x+h)^2} = \frac{x^2 - (x^2 + 2xh + h^2)}{hx^2(x+h)^2} = -\frac{2x+h}{x^2(x+h)^2}$$

$$76. \frac{(x+h)^3 - 7(x+h) - (x^3 - 7x)}{h} = \frac{x^3 + 3x^2h + 3xh^2 + h^3 - 7x - 7h - x^3 + 7x}{h} = \frac{3x^2h + 3xh^2 + h^3 - 7h}{h} \\ = \frac{h(3x^2 + 3xh + h^2 - 7)}{h} = 3x^2 + 3xh + h^2 - 7$$

$$77. \sqrt{1 + \left(\frac{x}{\sqrt{1-x^2}}\right)^2} = \sqrt{1 + \frac{x^2}{1-x^2}} = \sqrt{\frac{1-x^2}{1-x^2} + \frac{x^2}{1-x^2}} = \sqrt{\frac{1}{1-x^2}} = \frac{1}{\sqrt{1-x^2}}$$

$$78. \sqrt{1 + \left(x^3 - \frac{1}{4x^3}\right)^2} = \sqrt{1 + x^6 - \frac{2x^3}{4x^3} + \frac{1}{16x^6}} = \sqrt{1 + x^6 - \frac{1}{2} + \frac{1}{16x^6}} = \sqrt{x^6 + \frac{1}{2} + \frac{1}{16x^6}} \\ = \sqrt{\left(x^3 + \frac{1}{4x^3}\right)^2} = \left|x^3 + \frac{1}{4x^3}\right|$$

79.
$$\frac{3(x+2)^2(x-3)^2 - (x+2)^3(2)(x-3)}{(x-3)^4} = \frac{(x+2)^2(x-3)[3(x-3) - (x+2)(2)]}{(x-3)^4}$$

$$= \frac{(x+2)^2(3x-9-2x-4)}{(x-3)^3} = \frac{(x+2)^2(x-13)}{(x-3)^3}$$
80.
$$\frac{2x(x+6)^4 - x^2(4)(x+6)^3}{(x+6)^8} = \frac{(x+6)^3[2x(x+6) - 4x^2]}{(x+6)^8} = \frac{2x^2 + 12x - 4x^2}{(x+6)^5} = \frac{12x - 2x^2}{(x+6)^5} = \frac{2x(6-x)}{(x+6)^5}$$
81.
$$\frac{2(1+x)^{1/2} - x(1+x)^{-1/2}}{1+x} = \frac{(1+x)^{-1/2}[2(1+x) - x]}{1+x} = \frac{x+2}{(1+x)^{3/2}}$$
82.
$$\frac{(1-x^2)^{1/2} + x^2(1-x^2)^{-1/2}}{1-x^2} = \frac{(1-x^2)^{-1/2}(1-x^2+x^2)}{1-x^2} = \frac{1}{(1-x^2)^{3/2}}$$
83.
$$\frac{3(1+x)^{1/3} - x(1+x)^{-2/3}}{(1+x)^{2/3}} = \frac{(1+x)^{-2/3}[3(1+x) - x]}{(1+x)^{2/3}} = \frac{2x+3}{(1+x)^{4/3}}$$
84.
$$\frac{(7-3x)^{1/2} + \frac{3}{2}x(7-3x)^{-1/2}}{7-3x} = \frac{(7-3x)^{-1/2}(7-3x + \frac{3}{2}x)}{7-3x} = \frac{7 - \frac{3}{2}x}{(7-3x)^{3/2}}$$
85.
$$\frac{1}{5-\sqrt{3}} = \frac{1}{5-\sqrt{3}} \cdot \frac{5+\sqrt{3}}{5+\sqrt{3}} = \frac{5+\sqrt{3}}{25-3} = \frac{5+\sqrt{3}}{22}$$
86.
$$\frac{3}{2-\sqrt{5}} = \frac{(2+\sqrt{5})^3}{(2+\sqrt{5})(2-\sqrt{5})} = \frac{6+3\sqrt{5}}{4-5} = -6-3\sqrt{5}$$
87.
$$\frac{2}{\sqrt{2}+\sqrt{7}} = \frac{2}{\sqrt{2}+\sqrt{7}} \cdot \frac{\sqrt{2}-\sqrt{7}}{\sqrt{2}-\sqrt{7}} = \frac{2(\sqrt{2}-\sqrt{7})}{2-7} = \frac{2(\sqrt{2}-\sqrt{7})}{-5} = \frac{2(\sqrt{7}-\sqrt{2})}{5}$$
88.
$$\frac{1}{\sqrt{x}+1} = \frac{1}{\sqrt{x}+1} \cdot \frac{\sqrt{x}-1}{\sqrt{x}-1} = \frac{\sqrt{x}-1}{x-1}$$
89.
$$\frac{y}{\sqrt{3}+\sqrt{y}} = \frac{y}{\sqrt{3}+\sqrt{y}} \cdot \frac{\sqrt{3}-\sqrt{y}}{\sqrt{3}-\sqrt{y}} = \frac{y(\sqrt{3}-\sqrt{y})}{3-y} = \frac{y\sqrt{3}-y\sqrt{y}}{3-y}$$
90.
$$\frac{2(x-y)}{\sqrt{x}-\sqrt{y}} = \frac{2(x-y)}{\sqrt{x}-\sqrt{y}} \cdot \frac{\sqrt{x}+\sqrt{y}}{\sqrt{x}+\sqrt{y}} = \frac{2(x-y)(\sqrt{x}+\sqrt{y})}{x-y} = 2(\sqrt{x}+\sqrt{y}) = 2\sqrt{x}+2\sqrt{y}$$
91.
$$\frac{1-\sqrt{5}}{3} = \frac{1-\sqrt{5}}{3} \cdot \frac{1+\sqrt{5}}{1+\sqrt{5}} = \frac{1-5}{3(1+\sqrt{5})} = \frac{-4}{3(1+\sqrt{5})}$$
92.
$$\frac{\sqrt{3}+\sqrt{5}}{2} = \frac{\sqrt{3}+\sqrt{5}}{2} \cdot \frac{\sqrt{3}-\sqrt{5}}{\sqrt{3}-\sqrt{5}} = \frac{3-5}{2(\sqrt{3}-\sqrt{5})} = \frac{-2}{2(\sqrt{3}-\sqrt{5})} = \frac{-1}{\sqrt{3}-\sqrt{5}}$$
93.
$$\frac{\sqrt{r}+\sqrt{2}}{5} = \frac{\sqrt{r}+\sqrt{2}}{5} \cdot \frac{\sqrt{r}-\sqrt{2}}{\sqrt{r}-\sqrt{2}} = \frac{r-2}{5(\sqrt{r}-\sqrt{2})}$$
94.
$$\frac{\sqrt{x}-\sqrt{x+h}}{h\sqrt{x}\sqrt{x+h}} = \frac{\sqrt{x}-\sqrt{x+h}}{h\sqrt{x}\sqrt{x+h}} \cdot \frac{\sqrt{x}+\sqrt{x+h}}{\sqrt{x}+\sqrt{x+h}} = \frac{x-(x+h)}{h\sqrt{x}\sqrt{x+h}(\sqrt{x}+\sqrt{x+h})}$$

$$= \frac{-h}{h\sqrt{x}\sqrt{x+h}(\sqrt{x}+\sqrt{x+h})} = \frac{-1}{\sqrt{x}\sqrt{x+h}(\sqrt{x}+\sqrt{x+h})}$$
95.
$$\sqrt{x^2+1} - x = \frac{\sqrt{x^2+1} - x}{1} \cdot \frac{\sqrt{x^2+1} + x}{\sqrt{x^2+1} + x} = \frac{x^2+1-x^2}{\sqrt{x^2+1} + x} = \frac{1}{\sqrt{x^2+1} + x}$$

$$96. \sqrt{x+1} - \sqrt{x} = \frac{\sqrt{x+1} - \sqrt{x}}{1} \cdot \frac{\sqrt{x+1} + \sqrt{x}}{\sqrt{x+1} + \sqrt{x}} = \frac{x+1-x}{\sqrt{x+1} + \sqrt{x}} = \frac{1}{\sqrt{x+1} + \sqrt{x}}$$

$$97. \text{(a)} R = \frac{1}{\frac{1}{R_1} + \frac{1}{R_2}} = \frac{1}{\frac{1}{R_1} + \frac{1}{R_2}} \cdot \frac{R_1 R_2}{R_1 R_2} = \frac{R_1 R_2}{R_2 + R_1}$$

$$\text{(b) Substituting } R_1 = 10 \text{ ohms and } R_2 = 20 \text{ ohms gives } R = \frac{(10)(20)}{(20) + (10)} = \frac{200}{30} \approx 6.7 \text{ ohms.}$$

$$98. \text{(a) The average cost } A = \frac{\text{Cost}}{\text{number of shirts}} = \frac{500 + 6x + 0.01x^2}{x}.$$

(b)

x	10	20	50	100	200	500	1000
Average cost	\$56.10	\$31.20	\$16.50	\$12.00	\$10.50	\$12.00	\$16.50

99.

x	2.80	2.90	2.95	2.99	2.999	3	3.001	3.01	3.05	3.10	3.20
$\frac{x^2 - 9}{x - 3}$	5.80	5.90	5.95	5.99	5.999	?	6.001	6.01	6.05	6.10	6.20

From the table, we see that the expression $\frac{x^2 - 9}{x - 3}$ approaches 6 as x approaches 3. We simplify the expression:

$\frac{x^2 - 9}{x - 3} = \frac{(x - 3)(x + 3)}{x - 3} = x + 3, x \neq 3$. Clearly as x approaches 3, $x + 3$ approaches 6. This explains the result in the table.

100. No, squaring $\frac{2}{\sqrt{x}}$ changes its value by a factor of $\frac{2}{\sqrt{x}}$.

101. Answers will vary.

Algebraic Error	Counterexample
$\frac{1}{a} + \frac{1}{b} \neq \frac{1}{a+b}$	$\frac{1}{2} + \frac{1}{2} \neq \frac{1}{2+2}$
$(a+b)^2 \neq a^2 + b^2$	$(1+3)^2 \neq 1^2 + 3^2$
$\sqrt{a^2 + b^2} \neq a + b$	$\sqrt{5^2 + 12^2} \neq 5 + 12$
$\frac{a+b}{a} \neq b$	$\frac{2+6}{2} \neq 6$
$\frac{a}{a+b} \neq \frac{1}{b}$	$\frac{1}{1+1} \neq 1$
$\frac{a^m}{a^n} \neq a^{m/n}$	$\frac{3^5}{3^2} \neq 3^{5/2}$

102. (a) $\frac{5+a}{5} = \frac{5}{5} + \frac{a}{5} = 1 + \frac{a}{5}$, so the statement is true.

(b) This statement is false. For example, take $x = 5$ and $y = 2$. Then LHS = $\frac{x+1}{y+1} = \frac{5+1}{2+1} = \frac{6}{3} = 2$, while

$$\text{RHS} = \frac{x}{y} = \frac{5}{2}, \text{ and } 2 \neq \frac{5}{2}.$$

(c) This statement is false. For example, take $x = 0$ and $y = 1$. Then LHS = $\frac{x}{x+y} = \frac{0}{0+1} = 0$, while

$$\text{RHS} = \frac{1}{1+y} = \frac{1}{1+1} = \frac{1}{2}, \text{ and } 0 \neq \frac{1}{2}.$$

(d) This statement is false. For example, take $x = 1$ and $y = 1$. Then $\text{LHS} = 2\left(\frac{a}{b}\right) = 2\left(\frac{1}{1}\right) = 2$, while

$$\text{RHS} = \frac{2a}{2b} = \frac{2}{2} = 1, \text{ and } 2 \neq 1.$$

(e) This statement is true: $\frac{-a}{b} = (-a)\left(\frac{1}{b}\right) = (-1)(a)\left(\frac{1}{b}\right) = (-1)\left(\frac{a}{b}\right) = -\frac{a}{b}$.

(f) This statement is false. For example, take $x = 2$. Then $\text{LHS} = \frac{2}{4+x} = \frac{2}{4+2} = \frac{2}{6} = \frac{1}{3}$, while

$$\text{RHS} = \frac{1}{2} + \frac{2}{x} = \frac{1}{2} + \frac{2}{2} = \frac{3}{2}, \text{ and } \frac{1}{3} \neq \frac{3}{2}.$$

103. (a)

x	1	3	$\frac{1}{2}$	$\frac{9}{10}$	$\frac{99}{100}$	$\frac{999}{1000}$	$\frac{9999}{10,000}$
$x + \frac{1}{x}$	2	3.333	2.5	2.011	2.0001	2.000001	2.00000001

It appears that the smallest possible value of $x + \frac{1}{x}$ is 2.

(b) Because $x > 0$, we can multiply both sides by x and preserve the inequality: $x + \frac{1}{x} \geq 2 \Leftrightarrow x\left(x + \frac{1}{x}\right) \geq 2x \Leftrightarrow$

$x^2 + 1 \geq 2x \Leftrightarrow x^2 - 2x + 1 \geq 0 \Leftrightarrow (x - 1)^2 \geq 0$. The last statement is true for all $x > 0$, and because each step is

reversible, we have shown that $x + \frac{1}{x} \geq 2$ for all $x > 0$.

P.8 SOLVING BASIC EQUATIONS

- Substituting $x = 3$ in the equation $4x - 2 = 10$ makes the equation true, so the number 3 is a *solution* of the equation.
- Subtracting 4 from both sides of the given equation, $3x + 4 = 10$, we obtain $3x + 4 - 4 = 10 - 4 \Leftrightarrow 3x = 6$. Multiplying by $\frac{1}{3}$, we have $\frac{1}{3}(3x) = \frac{1}{3}(6) \Leftrightarrow x = 2$, so the solution is $x = 2$.
- (a) $\frac{x}{2} + 2x = 10$ is equivalent to $\frac{5}{2}x - 10 = 0$, so it is a linear equation.
 (b) $\frac{2}{x} - 2x = 1$ is not linear because it contains the term $\frac{2}{x}$, a multiple of the reciprocal of the variable.
 (c) $x + 7 = 5 - 3x \Leftrightarrow 4x - 2 = 0$, so it is linear.
- (a) $x(x + 1) = 6 \Leftrightarrow x^2 + x = 6$ is not linear because it contains the square of the variable.
 (b) $\sqrt{x + 2} = x$ is not linear because it contains the square root of $x + 2$.
 (c) $3x^2 - 2x - 1 = 0$ is not linear because it contains a multiple of the square of the variable.
- (a) This is true: If $a = b$, then $a + x = b + x$.
 (b) This is false, because the number could be zero. However, it is true that multiplying each side of an equation by a *nonzero* number always gives an equivalent equation.
 (c) This is false. For example, $-5 = 5$ is false, but $(-5)^2 = 5^2$ is true.
- To solve the equation $x^3 = 125$ we take the *cube* root of each side. So the solution is $x = \sqrt[3]{125} = 5$.
- (a) When $x = -2$, $\text{LHS} = 4(-2) + 7 = -8 + 7 = -1$ and $\text{RHS} = 9(-2) - 3 = -18 - 3 = -21$. Since $\text{LHS} \neq \text{RHS}$, $x = -2$ is not a solution.
 (b) When $x = 2$, $\text{LHS} = 4(-2) + 7 = 8 + 7 = 15$ and $\text{RHS} = 9(2) - 3 = 18 - 3 = 15$. Since $\text{LHS} = \text{RHS}$, $x = 2$ is a solution.
- (a) When $x = -1$, $\text{LHS} = 2 - 5(-1) = 2 + 5 = 7$ and $\text{RHS} = 8 + (-1) = 7$. Since $\text{LHS} = \text{RHS}$, $x = -1$ is a solution.
 (b) When $x = 1$, $\text{LHS} = 2 - 5(1) = 2 - 5 = -3$ and $\text{RHS} = 8 + (1) = 9$. Since $\text{LHS} \neq \text{RHS}$, $x = 1$ is not a solution.

9. (a) When $x = 2$, $\text{LHS} = 1 - [2 - (3 - (2))] = 1 - [2 - 1] = 1 - 1 = 0$ and $\text{RHS} = 4(2) - (6 + (2)) = 8 - 8 = 0$. Since $\text{LHS} = \text{RHS}$, $x = 2$ is a solution.
 (b) When $x = 4$ $\text{LHS} = 1 - [2 - (3 - (4))] = 1 - [2 - (-1)] = 1 - 3 = -2$ and $\text{RHS} = 4(4) - (6 + (4)) = 16 - 10 = 6$. Since $\text{LHS} \neq \text{RHS}$, $x = 4$ is not a solution.
10. (a) When $x = 2$, $\text{LHS} = \frac{1}{2} - \frac{1}{2-4} = \frac{1}{2} - \frac{1}{-2} = \frac{1}{2} + \frac{1}{2} = 1$ and $\text{RHS} = 1$. Since $\text{LHS} = \text{RHS}$, $x = 2$ is a solution.
 (b) When $x = 4$ the expression $\frac{1}{4-4}$ is not defined, so $x = 4$ is not a solution.
11. (a) When $x = -1$, $\text{LHS} = 2(-1)^{1/3} - 3 = 2(-1) - 3 = -2 - 3 = -5$. Since $\text{LHS} \neq 1$, $x = -1$ is not a solution.
 (b) When $x = 8$ $\text{LHS} = 2(8)^{1/3} - 3 = 2(2) - 3 = 4 - 3 = 1 = \text{RHS}$. So $x = 8$ is a solution.
12. (a) When $x = 4$, $\text{LHS} = \frac{4^{3/2}}{4-6} = \frac{2^3}{-2} = \frac{8}{-2} = -4$ and $\text{RHS} = (4) - 8 = -4$. Since $\text{LHS} = \text{RHS}$, $x = 4$ is a solution.
 (b) When $x = 8$, $\text{LHS} = \frac{8^{3/2}}{8-6} = \frac{(2^3)^{3/2}}{2} = \frac{2^{9/2}}{2} = 2^{7/2}$ and $\text{RHS} = (8) - 8 = 0$. Since $\text{LHS} \neq \text{RHS}$, $x = 8$ is not a solution.
13. (a) When $x = 0$, $\text{LHS} = \frac{0-a}{0-b} = \frac{-a}{-b} = \frac{a}{b} = \text{RHS}$. So $x = 0$ is a solution.
 (b) When $x = b$, $\text{LHS} = \frac{b-a}{b-b} = \frac{b-a}{0}$ is not defined, so $x = b$ is not a solution.
14. (a) When $x = \frac{b}{2}$, $\text{LHS} = \left(\frac{b}{2}\right)^2 - b\left(\frac{b}{2}\right) + \frac{1}{4}b^2 = \frac{b^2}{4} - \frac{b^2}{2} + \frac{b^2}{4} = 0 = \text{RHS}$. So $x = \frac{b}{2}$ is a solution.
 (b) When $x = \frac{1}{b}$, $\text{LHS} = \left(\frac{1}{b}\right)^2 - b\left(\frac{1}{b}\right) + \frac{1}{4}b^2 = \frac{1}{b^2} - 1 + \frac{b^2}{4}$, so $x = \frac{1}{b}$ is not a solution.
15. $5x - 6 = 14 \Leftrightarrow 5x = 20 \Leftrightarrow x = 4$
16. $3x + 4 = 7 \Leftrightarrow 3x = 3 \Leftrightarrow x = 1$
17. $7 - 2x = 15 \Leftrightarrow 2x = -8 \Leftrightarrow x = -4$
18. $4x - 95 = 1 \Leftrightarrow 4x = 96 \Leftrightarrow x = 24$
19. $\frac{1}{2}x + 7 = 3 \Leftrightarrow \frac{1}{2}x = -4 \Leftrightarrow x = -8$
20. $2 + \frac{1}{3}x = -4 \Leftrightarrow \frac{1}{3}x = -6 \Leftrightarrow x = -18$
21. $-3x - 3 = 5x - 3 \Leftrightarrow 0 = 8x \Leftrightarrow x = 0$
22. $2x + 3 = 5 - 2x \Leftrightarrow 4x = 2 \Leftrightarrow x = \frac{1}{2}$
23. $7x + 1 = 4 - 2x \Leftrightarrow 9x = 3 \Leftrightarrow x = \frac{1}{3}$
24. $1 - x = x + 4 \Leftrightarrow -3 = 2x \Leftrightarrow x = -\frac{3}{2}$
25. $-x + 3 = 4x \Leftrightarrow 3 = 5x \Leftrightarrow x = \frac{3}{5}$
26. $2x + 3 = 7 - 3x \Leftrightarrow 5x = 4 \Leftrightarrow x = \frac{4}{5}$
27. $\frac{x}{3} - 1 = \frac{5}{3}x + 7 \Leftrightarrow x - 3 = 5x + 21 \Leftrightarrow 4x = -24 \Leftrightarrow x = -6$
28. $\frac{2}{5}x - 1 = \frac{3}{10}x + 3 \Leftrightarrow 4x - 10 = 3x + 30 \Leftrightarrow x = 40$
29. $2(1-x) = 3(1+2x) + 5 \Leftrightarrow 2 - 2x = 3 + 6x + 5 \Leftrightarrow 2 - 2x = 8 + 6x \Leftrightarrow -6 = 8x \Leftrightarrow x = -\frac{3}{4}$
30. $5(x+3) + 9 = -2(x-2) - 1 \Leftrightarrow 5x + 15 + 9 = -2x + 4 - 1 \Leftrightarrow 5x + 24 = -2x + 3 \Leftrightarrow 7x = -21 \Leftrightarrow x = -3$
31. $4\left(y - \frac{1}{2}\right) - y = 6(5-y) \Leftrightarrow 4y - 2 - y = 30 - 6y \Leftrightarrow 3y - 2 = 30 - 6y \Leftrightarrow 9y = 32 \Leftrightarrow y = \frac{32}{9}$
32. $r - 2[1 - 3(2r + 4)] = 61 \Leftrightarrow r - 2(1 - 6r - 12) = 61 \Leftrightarrow r - 2(-6r - 11) = 61 \Leftrightarrow r + 12r + 22 = 61 \Leftrightarrow 13r = 39 \Leftrightarrow r = 3$
33. $x - \frac{1}{3}x - \frac{1}{2}x - 5 = 0 \Leftrightarrow 6x - 2x - 3x - 30 = 0$ (multiply both sides by 6) $\Leftrightarrow x = 30$
34. $\frac{2}{3}y + \frac{1}{2}(y-3) = \frac{y+1}{4} \Leftrightarrow 8y + 6(y-3) = 3(y+1) \Leftrightarrow 8y + 6y - 18 = 3y + 3 \Leftrightarrow 14y - 18 = 3y + 3 \Leftrightarrow 11y = 21 \Leftrightarrow y = \frac{21}{11}$

35. $2x - \frac{x}{2} + \frac{x+1}{4} = 6x \Leftrightarrow 8x - 2x + x + 1 = 24x \Leftrightarrow 7x + 1 = 24x \Leftrightarrow 1 = 17x \Leftrightarrow x = \frac{1}{17}$
36. $3x - \frac{5x}{2} = \frac{x+1}{3} - \frac{1}{6} \Leftrightarrow 18x - 15x = 2(x+1) - 1 \Leftrightarrow 3x = 2x + 1 \Leftrightarrow x = 1$
37. $(x-1)(x+2) = (x-2)(x-3) \Leftrightarrow x^2 + x - 2 = x^2 - 5x + 6 \Leftrightarrow x - 2 = -5x + 6 \Leftrightarrow 6x = 8 \Leftrightarrow x = \frac{4}{3}$
38. $x(x+1) = (x+3)^2 \Leftrightarrow x^2 + x = x^2 + 6x + 9 \Leftrightarrow x = 6x + 9 \Leftrightarrow -5x = 9 \Leftrightarrow x = -\frac{9}{5}$
39. $(x-1)(4x+5) = (2x-3)^2 \Leftrightarrow 4x^2 + x - 5 = 4x^2 - 12x + 9 \Leftrightarrow x - 5 = -12x + 9 \Leftrightarrow 13x = 14 \Leftrightarrow x = \frac{14}{13}$
40. $(t-4)^2 = (t+4)^2 + 32 \Leftrightarrow t^2 - 8t + 16 = t^2 + 8t + 16 + 32 \Leftrightarrow -16t = 32 \Leftrightarrow t = -2$
41. $\frac{1}{x} = \frac{4}{3x} + 1 \Rightarrow 3 = 4 + 3x$ (multiply both sides by the LCD, $3x$) $\Leftrightarrow -1 = 3x \Leftrightarrow x = -\frac{1}{3}$
42. $\frac{2}{x} - 5 = \frac{6}{x} + 4 \Rightarrow 2 - 5x = 6 + 4x \Leftrightarrow -4 = 9x \Leftrightarrow -\frac{4}{9} = x$
43. $\frac{2x-1}{x+2} = \frac{4}{5} \Rightarrow 5(2x-1) = 4(x+2) \Leftrightarrow 10x - 5 = 4x + 8 \Leftrightarrow 6x = 13 \Leftrightarrow x = \frac{13}{6}$
44. $\frac{2x-7}{2x+4} = \frac{2}{3} \Rightarrow (2x-7)3 = 2(2x+4)$ (cross multiply) $\Leftrightarrow 6x - 21 = 4x + 8 \Leftrightarrow 2x = 29 \Leftrightarrow x = \frac{29}{2}$
45. $\frac{2}{t+6} = \frac{3}{t-1} \Rightarrow 2(t-1) = 3(t+6)$ [multiply both sides by the LCD, $(t-1)(t+6)$] $\Leftrightarrow 2t - 2 = 3t + 18 \Leftrightarrow -20 = t$
46. $\frac{6}{x-3} = \frac{5}{x+4} \Rightarrow 6(x+4) = 5(x-3) \Leftrightarrow 6x + 24 = 5x - 15 \Leftrightarrow x = -39$
47. $\frac{3}{x+1} - \frac{1}{2} = \frac{1}{3x+3} \Rightarrow 3(6) - (3x+3) = 2$ [multiply both sides by $6(x+1)$] $\Leftrightarrow 18 - 3x - 3 = 2 \Leftrightarrow -3x + 15 = 2 \Leftrightarrow -3x = -13 \Leftrightarrow x = \frac{13}{3}$
48. $\frac{12x-5}{6x+3} = 2 - \frac{5}{x} \Rightarrow (12x-5)x = 2x(6x+3) - 5(6x+3) \Leftrightarrow 12x^2 - 5x = 12x^2 + 6x - 30x - 15 \Leftrightarrow 12x^2 - 5x = 12x^2 - 24x - 15 \Leftrightarrow 19x = -15 \Leftrightarrow x = -\frac{15}{19}$
49. $\frac{1}{z} - \frac{1}{2z} - \frac{1}{5z} = \frac{10}{z+1} \Rightarrow 10(z+1) - 5(z+1) - 2(z+1) = 10(10z)$ [multiply both sides by $10z(z+1)$] $\Leftrightarrow 3(z+1) = 100z \Leftrightarrow 3z + 3 = 100z \Leftrightarrow 3 = 97z \Leftrightarrow \frac{3}{97} = z$
50. $\frac{1}{3-t} + \frac{4}{3+t} + \frac{15}{9-t^2} = 0 \Rightarrow (3+t) + 4(3-t) + 15 = 0 \Leftrightarrow 3+t+12-4t+15 = 0 \Leftrightarrow -3t+30 = 0 \Leftrightarrow -3t = -30 \Leftrightarrow t = 10$
51. $\frac{x}{2x-4} - 2 = \frac{1}{x-2} \Rightarrow x - 2(2x-4) = 2$ [multiply both sides by $2(x-2)$] $\Leftrightarrow x - 4x + 8 = 2 \Leftrightarrow -3x = -6 \Leftrightarrow x = 2$.
But substituting $x = 2$ into the original equation does not work, since we cannot divide by 0. Thus there is no solution.
52. $\frac{1}{x+3} + \frac{5}{x^2-9} = \frac{2}{x-3} \Rightarrow (x-3) + 5 = 2(x+3) \Leftrightarrow x+2 = 2x+6 \Leftrightarrow x = -4$
53. $\frac{3}{x+4} = \frac{1}{x} + \frac{6x+12}{x^2+4x} \Rightarrow 3(x) = (x+4) + 6x + 12$ (multiply both sides by $x(x+4)$) $\Leftrightarrow 3x = 7x + 16 \Leftrightarrow -4x = 16 \Leftrightarrow x = -4$. But substituting $x = -4$ into the original equation does not work, since we cannot divide by 0. Thus, there is no solution.
54. $\frac{1}{x} - \frac{2}{2x+1} = \frac{1}{2x^2+x} \Rightarrow (2x+1) - 2(x) = 1 \Leftrightarrow 1 = 1$. This is an identity for $x \neq 0$ and $x \neq -\frac{1}{2}$, so the solutions are all real numbers except 0 and $-\frac{1}{2}$.
55. $x^2 = 25 \Leftrightarrow x = \pm 5$
56. $3x^2 = 48 \Leftrightarrow x^2 = 16 \Leftrightarrow x = \pm 4$
57. $5x^2 = 15 \Leftrightarrow x^2 = 3 \Leftrightarrow x = \pm\sqrt{3}$

58. $x^2 = 1000 \Leftrightarrow x = \pm\sqrt{1000} = \pm 10\sqrt{10}$
59. $8x^2 - 64 = 0 \Leftrightarrow x^2 - 8 = 0 \Leftrightarrow x^2 = 8 \Leftrightarrow x = \pm\sqrt{8} = \pm 2\sqrt{2}$
60. $5x^2 - 125 = 0 \Leftrightarrow 5(x^2 - 25) = 0 \Leftrightarrow x^2 = 25 \Leftrightarrow x = \pm 5$
61. $x^2 + 16 = 0 \Leftrightarrow x^2 = -16$ which has no real solution.
62. $6x^2 + 100 = 0 \Leftrightarrow 6x^2 = -100 \Leftrightarrow x^2 = -\frac{50}{3}$, which has no real solution.
63. $(x - 3)^2 = 5 \Leftrightarrow x - 3 = \pm\sqrt{5} \Leftrightarrow x = 3 \pm \sqrt{5}$
64. $(3x - 4)^2 = 7 \Leftrightarrow 3x - 4 = \pm\sqrt{7} \Leftrightarrow 3x = 4 \pm \sqrt{7} \Leftrightarrow x = \frac{4 \pm \sqrt{7}}{3}$
65. $x^3 = 27 \Leftrightarrow x = 27^{1/3} = 3$
66. $x^5 + 32 = 0 \Leftrightarrow x^5 = -32 \Leftrightarrow x = -32^{1/5} = -2$
67. $0 = x^4 - 16 = (x^2 + 4)(x^2 - 4) = (x^2 + 4)(x - 2)(x + 2)$. $x^2 + 4 = 0$ has no real solution. If $x - 2 = 0$, then $x = 2$. If $x + 2 = 0$, then $x = -2$. The solutions are ± 2 .
68. $64x^6 = 27 \Leftrightarrow x^6 = \frac{27}{64} \Rightarrow x = \pm \left(\frac{27}{64}\right)^{1/6} = \pm \frac{27^{1/6}}{64^{1/6}} = \pm \frac{\sqrt{3}}{2}$
69. $x^4 + 64 = 0 \Leftrightarrow x^4 = -64$ which has no real solution.
70. $(x - 1)^3 + 8 = 0 \Leftrightarrow (x - 1)^3 = -8 \Leftrightarrow x - 1 = (-8)^{1/3} = -2 \Leftrightarrow x = -1$.
71. $(x + 2)^4 - 81 = 0 \Leftrightarrow (x + 2)^4 = 81 \Leftrightarrow [(x + 2)^4]^{1/4} = \pm 81^{1/4} \Leftrightarrow x + 2 = \pm 3$. So $x + 2 = 3$, then $x = 1$. If $x + 2 = -3$, then $x = -5$. The solutions are -5 and 1 .
72. $(x + 1)^4 + 16 = 0 \Leftrightarrow (x + 1)^4 = -16$, which has no real solution.
73. $3(x - 3)^3 = 375 \Leftrightarrow (x - 3)^3 = 125 \Leftrightarrow (x - 3) = 125^{1/3} = 5 \Leftrightarrow x = 3 + 5 = 8$
74. $4(x + 2)^5 = 1 \Leftrightarrow (x + 2)^5 = \frac{1}{4} \Rightarrow x + 2 = \sqrt[5]{\frac{1}{4}} \Leftrightarrow x = -2 + \sqrt[5]{\frac{1}{4}}$
75. $\sqrt[3]{x} = 5 \Leftrightarrow x = 5^3 = 125$
76. $x^{4/3} - 16 = 0 \Leftrightarrow x^{4/3} = 16 = 2^4 \Leftrightarrow (x^{4/3})^3 = (2^4)^3 = 2^{12} \Leftrightarrow x^4 = 2^{12} \Leftrightarrow x = \pm (2^{12})^{1/4} = \pm 2^3 = \pm 8$
77. $2x^{5/3} + 64 = 0 \Leftrightarrow 2x^{5/3} = -64 \Leftrightarrow x^{5/3} = -32 \Leftrightarrow x = (-32)^{3/5} = (-2^5)^{1/5} = (-2)^3 = -8$
78. $6x^{2/3} - 216 = 0 \Leftrightarrow 6x^{2/3} = 216 \Leftrightarrow x^{2/3} = 36 = (\pm 6)^2 \Leftrightarrow (x^{2/3})^{3/2} = [(\pm 6)^2]^{3/2} \Leftrightarrow x = (\pm 6)^3 = \pm 216$
79. $3.02x + 1.48 = 10.92 \Leftrightarrow 3.02x = 9.44 \Leftrightarrow x = \frac{9.44}{3.02} \approx 3.13$
80. $8.36 - 0.95x = 9.97 \Leftrightarrow -0.95x = 1.61 \Leftrightarrow x = \frac{1.61}{-0.95} \approx -1.69$
81. $2.15x - 4.63 = x + 1.19 \Leftrightarrow 1.15x = 5.82 \Leftrightarrow x = \frac{5.82}{1.19} \approx 5.06$
82. $3.95 - x = 2.32x + 2.00 \Leftrightarrow 1.95 = 3.32x \Leftrightarrow x = \frac{1.95}{3.32} \approx 0.59$
83. $3.16(x + 4.63) = 4.19(x - 7.24) \Leftrightarrow 3.16x + 14.63 = 4.19x - 30.34 \Leftrightarrow 44.97 = 1.03x \Leftrightarrow x = \frac{44.97}{1.03} \approx 43.66$
84. $2.14(x - 4.06) = 2.27 - 0.11x \Leftrightarrow 2.14x - 8.6684 = 2.27 - 0.11x \Leftrightarrow 2.25x = 10.9584 \Leftrightarrow x = 4.8704 \approx 4.87$
85. $\frac{0.26x - 1.94}{3.03 - 2.44x} = 1.76 \Rightarrow 0.26x - 1.94 = 1.76(3.03 - 2.44x) \Leftrightarrow 0.26x - 1.94 = 5.33 - 4.29x \Leftrightarrow 4.55x = 7.27 \Leftrightarrow x = \frac{7.27}{4.55} \approx 1.60$
86. $\frac{1.73x}{2.12 + x} = 1.51 \Leftrightarrow 1.73x = 1.51(2.12 + x) \Leftrightarrow 1.73x = 3.20 + 1.51x \Leftrightarrow 0.22x = 3.20 \Leftrightarrow x = \frac{3.20}{0.22} \approx 14.55$

87. $r = \frac{12}{M} \Leftrightarrow M = \frac{12}{r}$

88. $wd = rTH \Leftrightarrow T = \frac{wd}{rH}$

89. $PV = nRT \Leftrightarrow R = \frac{PV}{nT}$

90. $F = G \frac{mM}{r^2} \Leftrightarrow m = \frac{Fr^2}{GM}$

91. $P = 2l + 2w \Leftrightarrow 2w = P - 2l \Leftrightarrow w = \frac{P - 2l}{2}$

92. $\frac{1}{R} = \frac{1}{R_1} + \frac{1}{R_2} \Leftrightarrow R_1R_2 = RR_2 + RR_1$ (multiply both sides by the LCD, RR_1R_2). Thus $R_1R_2 - RR_1 = RR_2 \Leftrightarrow R_1(R_2 - R) = RR_2 \Leftrightarrow R_1 = \frac{RR_2}{R_2 - R}$.

93. $V = \frac{1}{3}\pi r^2 h \Leftrightarrow r^2 = \frac{3V}{\pi h} \Rightarrow r = \pm\sqrt{\frac{3V}{\pi h}}$

94. $F = G \frac{mM}{r^2} \Leftrightarrow r^2 = G \frac{mM}{F} \Rightarrow r = \pm\sqrt{G \frac{mM}{F}}$

95. $V = \frac{4}{3}\pi r^3 \Leftrightarrow r^3 = \frac{3V}{4\pi} \Leftrightarrow r = \sqrt[3]{\frac{3V}{4\pi}}$

96. $a^2 + b^2 = c^2 \Leftrightarrow b^2 = c^2 - a^2 \Rightarrow b = \pm\sqrt{c^2 - a^2}$

97. $A = P \left(1 + \frac{i}{100}\right)^2 \Leftrightarrow \frac{A}{P} = \left(1 + \frac{i}{100}\right)^2 \Rightarrow 1 + \frac{i}{100} = \pm\sqrt{\frac{A}{P}} \Leftrightarrow \frac{i}{100} = -1 \pm \sqrt{\frac{A}{P}} \Leftrightarrow i = -100 \pm 100\sqrt{\frac{A}{P}}$

98. $a^2x + (a-1)x = (a+1)x \Leftrightarrow a^2x - (a+1)x = -(a-1)x \Leftrightarrow (a^2 - (a+1))x = -a+1 \Leftrightarrow (a^2 - a - 1)x = -a+1$
 $\Leftrightarrow x = \frac{-a+1}{a^2 - a - 1}$

99. $\frac{ax+b}{cx+d} = 2 \Leftrightarrow ax+b = 2(cx+d) \Leftrightarrow ax+b = 2cx+2d \Leftrightarrow ax-2cx = 2d-b \Leftrightarrow (a-2c)x = 2d-b \Leftrightarrow x = \frac{2d-b}{a-2c}$

100. $\frac{a+1}{b} = \frac{a-1}{b} + \frac{b+1}{a} \Leftrightarrow a(a+1) = a(a-1) + b(b+1) \Leftrightarrow a^2+a = a^2-a+b^2+b \Leftrightarrow 2a = b^2+b \Leftrightarrow a = \frac{1}{2}(b^2+b)$

101. (a) The shrinkage factor when $w = 250$ is $S = \frac{0.032(250) - 2.5}{10,000} = \frac{8 - 2.5}{10,000} = 0.00055$. So the beam shrinks $0.00055 \times 12.025 \approx 0.007$ m, so when it dries it will be $12.025 - 0.007 = 12.018$ m long.

(b) Substituting $S = 0.00050$ we get $0.00050 = \frac{0.032w - 2.5}{10,000} \Leftrightarrow 5 = 0.032w - 2.5 \Leftrightarrow 7.5 = 0.032w \Leftrightarrow w = \frac{7.5}{0.032} \approx 234.375$. So the water content should be 234.375 kg/m³.

102. Substituting $C = 3600$ we get $3600 = 450 + 3.75x \Leftrightarrow 3150 = 3.75x \Leftrightarrow x = \frac{3150}{3.75} = 840$. So the toy manufacturer can manufacture 840 toy trucks.

103. (a) Solving for v when $P = 10,000$ we get $10,000 = 15.6v^3 \Leftrightarrow v^3 \approx 641.02 \Leftrightarrow v \approx 8.6$ km/h.

(b) Solving for v when $P = 50,000$ we get $50,000 = 15.6v^3 \Leftrightarrow v^3 \approx 3205.13 \Leftrightarrow v \approx 14.7$ km/h.

104. Substituting $F = 300$ we get $300 = 0.3x^{3/4} \Leftrightarrow 1000 = 10^3 = x^{3/4} \Leftrightarrow x^{1/4} = 10 \Leftrightarrow x = 10^4 = 10,000$ lb.

105. (a) $3(0) + k - 5 = k(0) - k + 1 \Leftrightarrow k - 5 = -k + 1 \Leftrightarrow 2k = 6 \Leftrightarrow k = 3$

(b) $3(1) + k - 5 = k(1) - k + 1 \Leftrightarrow 3 + k - 5 = k - k + 1 \Leftrightarrow k - 2 = 1 \Leftrightarrow k = 3$

(c) $3(2) + k - 5 = k(2) - k + 1 \Leftrightarrow 6 + k - 5 = 2k - k + 1 \Leftrightarrow k + 1 = k + 1$. $x = 2$ is a solution for every value of k .

That is, $x = 2$ is a solution to every member of this family of equations.

106. When we multiplied by x , we introduced $x = 0$ as a solution. When we divided by $x - 1$, we are really dividing by 0, since $x = 1 \Leftrightarrow x - 1 = 0$.

P.9 MODELING WITH EQUATIONS

- An equation modeling a real-world situation can be used to help us understand a real-world problem using mathematical methods. We translate real-world ideas into the language of algebra to construct our model, and translate our mathematical results back into real-world ideas in order to interpret our findings.
- In the formula $I = Prt$ for simple interest, P stands for *principal*, r for *interest rate*, and t for *time (in years)*.
- (a) A square of side x has area $A = x^2$.
(b) A rectangle of length l and width w has area $A = lw$.
(c) A circle of radius r has area $A = \pi r^2$.
- Balsamic vinegar contains 5% acetic acid, so a 32 ounce bottle of balsamic vinegar contains $32 \cdot 5\% = 32 \cdot \frac{5}{100} = 1.6$ ounces of acetic acid.
- A painter paints a wall in x hours, so the fraction of the wall she paints in one hour is $\frac{1 \text{ wall}}{x \text{ hours}} = \frac{1}{x}$.
- Solving $d = rt$ for r , we find $\frac{d}{t} = \frac{rt}{t} \Rightarrow r = \frac{d}{t}$. Solving $d = rt$ for t , we find $\frac{d}{r} = \frac{rt}{r} \Rightarrow t = \frac{d}{r}$.
- If n is the first integer, then $n + 1$ is the middle integer, and $n + 2$ is the third integer. So the sum of the three consecutive integers is $n + (n + 1) + (n + 2) = 3n + 3$.
- If n is the middle integer, then $n - 1$ is the first integer, and $n + 1$ is the third integer. So the sum of the three consecutive integers is $(n - 1) + n + (n + 1) = 3n$.
- If n is the first even integer, then $n + 2$ is the second even integer and $n + 4$ is the third. So the sum of three consecutive even integers is $n + (n + 2) + (n + 4) = 3n + 6$.
- If n is the first integer, then the next integer is $n + 1$. The sum of their squares is $n^2 + (n + 1)^2 = n^2 + (n^2 + 2n + 1) = 2n^2 + 2n + 1$.
- If s is the third test score, then since the other test scores are 78 and 82, the average of the three test scores is $\frac{78 + 82 + s}{3} = \frac{160 + s}{3}$.
- If q is the fourth quiz score, then since the other quiz scores are 8, 8, and 8, the average of the four quiz scores is $\frac{8 + 8 + 8 + q}{4} = \frac{24 + q}{4}$.
- If x dollars are invested at $2\frac{1}{2}\%$ simple interest, then the first year you will receive $0.025x$ dollars in interest.
- If n is the number of months the apartment is rented, and each month the rent is \$795, then the total rent paid is $795n$.
- Since w is the width of the rectangle, the length is four times the width, or $4w$. Then
$$\text{area} = \text{length} \times \text{width} = 4w \times w = 4w^2 \text{ ft}^2$$
- Since w is the width of the rectangle, the length is $w + 4$. Then
$$\text{perimeter} = 2 \times \text{length} + 2 \times \text{width} = 2(w + 4) + 2(w) = (4w + 8) \text{ ft}$$
- If d is the given distance, in miles, and distance = rate \times time, we have time = $\frac{\text{distance}}{\text{rate}} = \frac{d}{55}$.
- Since distance = rate \times time we have distance = $s \times (45 \text{ min}) \frac{1 \text{ h}}{60 \text{ min}} = \frac{3}{4}s \text{ mi}$.
- If x is the quantity of pure water added, the mixture will contain 25 oz of salt and $3 + x$ gallons of water. Thus the concentration is $\frac{25}{3 + x}$.
- If p is the number of pennies in the purse, then the number of nickels is $2p$, the number of dimes is $4 + 2p$, and the number of quarters is $(2p) + (4 + 2p) = 4p + 4$. Thus the value (in cents) of the change in the purse is $1 \cdot p + 5 \cdot 2p + 10 \cdot (4 + 2p) + 25 \cdot (4p + 4) = p + 10p + 40 + 20p + 100p + 100 = 131p + 140$.

21. If d is the number of days and m the number of miles, then the cost of a rental is $C = 65d + 0.20m$. In this case, $d = 3$ and $C = 275$, so we solve for m : $275 = 65 \cdot 3 + 0.20m \Leftrightarrow 275 = 195 + 0.2m \Leftrightarrow 0.2m = 80 \Leftrightarrow m = \frac{80}{0.2} = 400$. Thus, Michael drove 400 miles.
22. If m is the number of messages, then a monthly cell phone bill (above \$10) is $B = 10 + 0.10(m - 1000)$. In this case, $B = 38.5$ and we solve for m : $38.5 = 10 + 0.10(m - 1000) \Leftrightarrow 0.10(m - 1000) = 28.5 \Leftrightarrow m - 1000 = \frac{28.5}{0.1} = 285 \Leftrightarrow m = 1285$. Thus, Miriam sent 1285 text messages in June.
23. If x is Linh's score on her final exam, then because the final counts twice as much as each midterm, her average score is $\frac{82 + 75 + 71 + 2x}{3(100) + 200} = \frac{228 + 2x}{500} = \frac{114 + x}{250}$. For her to average 80%, we must have $\frac{114 + x}{250} = 80\% = 0.8 \Leftrightarrow 114 + x = 250(0.8) = 200 \Leftrightarrow x = 86$. So Linh scored 86% on her final exam.
24. Six students scored 100 and three students scored 60. Let x be the average score of the remaining $25 - 6 - 3 = 16$ students. Because the overall average is $84\% = 0.84$, we have $\frac{6(100) + 3(60) + 16x}{25(100)} = 0.84 \Leftrightarrow 780 + 16x = 0.84(2500) = 2100 \Leftrightarrow 16x = 1320 \Leftrightarrow x = \frac{1320}{16} = 82.5$. Thus, the remaining 16 students' average score was 82.5%.
25. Let m be the amount invested at $4\frac{1}{2}\%$. Then $12,000 - m$ is the amount invested at 4%. Since the total interest is equal to the interest earned at $4\frac{1}{2}\%$ plus the interest earned at 4%, we have $525 = 0.045m + 0.04(12,000 - m) \Leftrightarrow 525 = 0.045m + 480 - 0.04m \Leftrightarrow 45 = 0.005m \Leftrightarrow m = \frac{45}{0.005} = 9000$. Thus \$9000 is invested at $4\frac{1}{2}\%$, and $\$12,000 - 9000 = \3000 is invested at 4%.
26. Let m be the amount invested at $5\frac{1}{2}\%$. Then $4000 + m$ is the total amount invested. Thus $4\frac{1}{2}\%$ of the total investment = interest earned at 4% + interest earned at $5\frac{1}{2}\%$
So $0.045(4000 + m) = 0.04(4000) + 0.055m \Leftrightarrow 180 + 0.045m = 160 + 0.055m \Leftrightarrow 20 = 0.01m \Leftrightarrow m = \frac{20}{0.01} = 2000$.
Thus \$2,000 needs to be invested at $5\frac{1}{2}\%$.
27. Using the formula $I = Prt$ and solving for r , we get $262.50 = 3500 \cdot r \cdot 1 \Leftrightarrow r = \frac{262.5}{3500} = 0.075$ or 7.5%.
28. If \$1000 is invested at an interest rate $a\%$, then 2000 is invested at $(a + \frac{1}{2})\%$, so, remembering that a is expressed as a percentage, the total interest is $I = 1000 \cdot \frac{a}{100} \cdot 1 + 2000 \cdot \frac{a + \frac{1}{2}}{100} \cdot 1 = 10a + 20a + 10 = 30a + 10$. Since the total interest is \$190, we have $190 = 30a + 10 \Leftrightarrow 180 = 30a \Leftrightarrow a = 6$. Thus, the \$1000 is invested at 6% interest.
29. Let x be her monthly salary. Since her annual salary = $12 \times$ (monthly salary) + (Christmas bonus) we have $97,300 = 12x + 8,500 \Leftrightarrow 88,800 = 12x \Leftrightarrow x \approx 7,400$. Her monthly salary is \$7,400.
30. Let s be the husband's annual salary. Then her annual salary is $1.15s$. Since husband's annual salary + wife's annual salary = total annual income, we have $s + 1.15s = 69,875 \Leftrightarrow 2.15s = 69,875 \Leftrightarrow s = 32,500$. Thus the husband's annual salary is \$32,500.
31. Let x be the overtime hours Helen works. Since gross pay = regular salary + overtime pay, we obtain the equation $352.50 = 7.50 \times 35 + 7.50 \times 1.5 \times x \Leftrightarrow 352.50 = 262.50 + 11.25x \Leftrightarrow 90 = 11.25x \Leftrightarrow x = \frac{90}{11.25} = 8$. Thus Helen worked 8 hours of overtime.
32. Let x be the hours the assistant worked. Then $2x$ is the hours the plumber worked. Since the labor charge is equal to the plumber's labor plus the assistant's labor, we have $4025 = 45(2x) + 25x \Leftrightarrow 4025 = 90x + 25x \Leftrightarrow 4025 = 115x \Leftrightarrow x = \frac{4025}{115} = 35$. Thus the assistant works for 35 hours, and the plumber works for $2 \times 35 = 70$ hours.

33. All ages are in terms of the daughter's age 7 years ago. Let y be age of the daughter 7 years ago. Then $11y$ is the age of the movie star 7 years ago. Today, the daughter is $y + 7$, and the movie star is $11y + 7$. But the movie star is also 4 times his daughter's age today. So $4(y + 7) = 11y + 7 \Leftrightarrow 4y + 28 = 11y + 7 \Leftrightarrow 21 = 7y \Leftrightarrow y = 3$. Thus the movie star's age today is $11(3) + 7 = 40$ years.

34. Let h be number of home runs Babe Ruth hit. Then $h + 41$ is the number of home runs that Hank Aaron hit. So $1469 = h + h + 41 \Leftrightarrow 1428 = 2h \Leftrightarrow h = 714$. Thus Babe Ruth hit 714 home runs.

35. Let p be the number of pennies. Then p is the number of nickels and p is the number of dimes. So the value of the coins in the purse is the value of the pennies plus the value of the nickels plus the value of the dimes. Thus $1.44 = 0.01p + 0.05p + 0.10p \Leftrightarrow 1.44 = 0.16p \Leftrightarrow p = \frac{1.44}{0.16} = 9$. So the purse contains 9 pennies, 9 nickels, and 9 dimes.

36. Let q be the number of quarters. Then $2q$ is the number of dimes, and $2q + 5$ is the number of nickels. Thus $3.00 = \text{value of the nickels} + \text{value of the dimes} + \text{value of the quarters}$. So

$$3.00 = 0.05(2q + 5) + 0.10(2q) + 0.25q \Leftrightarrow 3.00 = 0.10q + 0.25 + 0.20q + 0.25q \Leftrightarrow 2.75 = 0.55q \Leftrightarrow q = \frac{2.75}{0.55} = 5.$$

Thus Mary has 5 quarters, $2(5) = 10$ dimes, and $2(5) + 5 = 15$ nickels.

37. Let l be the length of the garden. Since $\text{area} = \text{width} \cdot \text{length}$, we obtain the equation $1125 = 25l \Leftrightarrow l = \frac{1125}{25} = 45$ ft. So the garden is 45 feet long.

38. Let w be the width of the pasture. Then the length of the pasture is $2w$. Since $\text{area} = \text{length} \times \text{width}$ we have $115,200 = w(2w) = 2w^2 \Leftrightarrow w^2 = 57,600 \Rightarrow w = \pm 240$. Thus the width of the pasture is 240 feet.

39. Let x be the length of a side of the square plot. As shown in the figure, $\text{area of the plot} = \text{area of the building} + \text{area of the parking lot}$. Thus,

$$x^2 = 60(40) + 12,000 = 2,400 + 12,000 = 14,400 \Rightarrow x = \pm 120.$$

So the plot of land measures 120 feet by 120 feet.

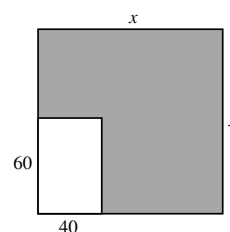

40. Let w be the width of the building lot. Then the length of the building lot is $5w$. Since a half-acre is $\frac{1}{2} \cdot 43,560 = 21,780$ and $\text{area} = \text{length} \times \text{width}$, we have $21,780 = w(5w) = 5w^2 \Leftrightarrow w^2 = 4,356 \Rightarrow w = \pm 66$. Thus the width of the building lot is 66 feet and the length of the building lot is $5(66) = 330$ feet.

41. The figure is a trapezoid, so its area is $\frac{\text{base}_1 + \text{base}_2}{2}(\text{height})$. Putting in the known quantities, we have

$$120 = \frac{y + 2y}{2}(y) = \frac{3}{2}y^2 \Leftrightarrow y^2 = 80 \Rightarrow y = \pm\sqrt{80} = \pm 4\sqrt{5}.$$

Since length is positive, $y = 4\sqrt{5} \approx 8.94$ inches.

42. First we write a formula for the area of the figure in terms of x . Region A has dimensions 10 cm and x cm and region B has dimensions 6 cm and x cm. So the shaded region has area $(10 \cdot x) + (6 \cdot x) = 16x \text{ cm}^2$. We are given that this is equal to 144 cm^2 , so $144 = 16x \Leftrightarrow x = \frac{144}{16} = 9$ cm.

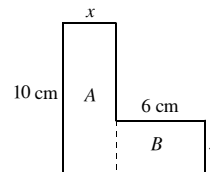

43. Let x be the width of the strip. Then the length of the mat is $20 + 2x$, and the width of the mat is $15 + 2x$. Now the perimeter is twice the length plus twice the width, so $102 = 2(20 + 2x) + 2(15 + 2x) \Leftrightarrow 102 = 40 + 4x + 30 + 4x \Leftrightarrow 102 = 70 + 8x \Leftrightarrow 32 = 8x \Leftrightarrow x = 4$. Thus the strip of mat is 4 inches wide.

44. Let x be the width of the strip. Then the width of the poster is $100 + 2x$ and its length is $140 + 2x$. The perimeter of the printed area is $2(100) + 2(140) = 480$, and the perimeter of the poster is $2(100 + 2x) + 2(140 + 2x)$. Now we use the fact that the perimeter of the poster is $1\frac{1}{2}$ times the perimeter of the printed area: $2(100 + 2x) + 2(140 + 2x) = \frac{3}{2} \cdot 480 \Leftrightarrow 480 + 8x = 720 \Leftrightarrow 8x = 240 \Leftrightarrow x = 30$. The blank strip is thus 30 cm wide.

45. Let x be the length of the man's shadow, in meters. Using similar triangles, $\frac{10+x}{6} = \frac{x}{2} \Leftrightarrow 20 + 2x = 6x \Leftrightarrow 4x = 20 \Leftrightarrow x = 5$. Thus the man's shadow is 5 meters long.

46. Let x be the height of the tall tree. Here we use the property that corresponding sides in similar triangles are proportional. The base of the similar triangles starts at eye level of the woodcutter, 5 feet. Thus we obtain the proportion $\frac{x-5}{15} = \frac{150}{25} \Leftrightarrow 25(x-5) = 15(150) \Leftrightarrow 25x - 125 = 2250 \Leftrightarrow 25x = 2375 \Leftrightarrow x = 95$. Thus the tree is 95 feet tall.

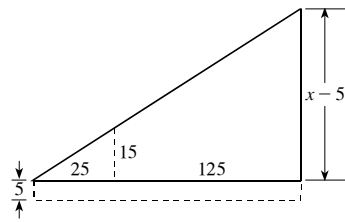

47. Let x be the amount (in mL) of 60% acid solution to be used. Then $300 - x$ mL of 30% solution would have to be used to yield a total of 300 mL of solution.

	60% acid	30% acid	Mixture
mL	x	$300 - x$	300
Rate (% acid)	0.60	0.30	0.50
Value	$0.60x$	$0.30(300 - x)$	$0.50(300)$

Thus the total amount of pure acid used is $0.60x + 0.30(300 - x) = 0.50(300) \Leftrightarrow 0.3x + 90 = 150 \Leftrightarrow x = \frac{60}{0.3} = 200$. So 200 mL of 60% acid solution must be mixed with 100 mL of 30% solution to get 300 mL of 50% acid solution.

48. The amount of pure acid in the original solution is $300(50\%) = 150$. Let x be the number of mL of pure acid added. Then the final volume of solution is $300 + x$. Because its concentration is to be 60%, we must have $\frac{150+x}{300+x} = 60\% = 0.6 \Leftrightarrow 150 + x = 0.6(300 + x) \Leftrightarrow 150 + x = 180 + 0.6x \Leftrightarrow 0.4x = 30 \Leftrightarrow x = \frac{30}{0.4} = 75$. Thus, 75 mL of pure acid must be added.

49. Let x be the number of grams of silver added. The weight of the rings is $5 \times 18 \text{ g} = 90 \text{ g}$.

	5 rings	Pure silver	Mixture
Grams	90	x	$90 + x$
Rate (% gold)	0.90	0	0.75
Value	$0.90(90)$	$0x$	$0.75(90 + x)$

So $0.90(90) + 0x = 0.75(90 + x) \Leftrightarrow 81 = 67.5 + 0.75x \Leftrightarrow 0.75x = 13.5 \Leftrightarrow x = \frac{13.5}{0.75} = 18$. Thus 18 grams of silver must be added to get the required mixture.

50. Let x be the number of liters of water to be boiled off. The result will contain $6 - x$ liters.

	Original	Water	Final
Liters	6	$-x$	$6 - x$
Concentration	120	0	200
Amount	$120(6)$	0	$200(6 - x)$

So $120(6) + 0 = 200(6 - x) \Leftrightarrow 720 = 1200 - 200x \Leftrightarrow 200x = 480 \Leftrightarrow x = 2.4$. Thus 2.4 liters need to be boiled off.

51. Let x be the number of liters of coolant removed and replaced by water.

	60% antifreeze	60% antifreeze (removed)	Water	Mixture
Liters	3.6	x	x	3.6
Rate (% antifreeze)	0.60	0.60	0	0.50
Value	$0.60(3.6)$	$-0.60x$	$0x$	$0.50(3.6)$

So $0.60(3.6) - 0.60x + 0x = 0.50(3.6) \Leftrightarrow 2.16 - 0.6x = 1.8 \Leftrightarrow -0.6x = -0.36 \Leftrightarrow x = \frac{-0.36}{-0.6} = 0.6$. Thus 0.6 liters must be removed and replaced by water.

52. Let x be the number of gallons of 2% bleach removed from the tank. This is also the number of gallons of pure bleach added to make the 5% mixture.

	Original 2%	Pure bleach	5% mixture
Gallons	$100 - x$	x	100
Concentration	0.02	1	0.05
Bleach	$0.02(100 - x)$	$1x$	$0.05 \cdot 100$

So $0.02(100 - x) + x = 0.05 \cdot 100 \Leftrightarrow 2 - 0.02x + x = 5 \Leftrightarrow 0.98x = 3 \Leftrightarrow x = 3.06$. Thus 3.06 gallons need to be removed and replaced with pure bleach.

53. Let c be the concentration of fruit juice in the cheaper brand. The new mixture that Jill makes will consist of 650 mL of the original fruit punch and 100 mL of the cheaper fruit punch.

	Original Fruit Punch	Cheaper Fruit Punch	Mixture
mL	650	100	750
Concentration	0.50	c	0.48
Juice	$0.50 \cdot 650$	$100c$	$0.48 \cdot 750$

So $0.50 \cdot 650 + 100c = 0.48 \cdot 750 \Leftrightarrow 325 + 100c = 360 \Leftrightarrow 100c = 35 \Leftrightarrow c = 0.35$. Thus the cheaper brand is only 35% fruit juice.

54. Let x be the number of ounces of \$3.00/oz tea. Then $80 - x$ is the number of ounces of \$2.75/oz tea.

	\$3.00 tea	\$2.75 tea	Mixture
Pounds	x	$80 - x$	80
Rate (cost per ounce)	3.00	2.75	2.90
Value	$3.00x$	$2.75(80 - x)$	$2.90(80)$

So $3.00x + 2.75(80 - x) = 2.90(80) \Leftrightarrow 3.00x + 220 - 2.75x = 232 \Leftrightarrow 0.25x = 12 \Leftrightarrow x = 48$. The mixture uses 48 ounces of \$3.00/oz tea and $80 - 48 = 32$ ounces of \$2.75/oz tea.

55. Let t be the time in minutes it would take Candy and Tim if they work together. Candy delivers the papers at a rate of $\frac{1}{70}$ of the job per minute, while Tim delivers the paper at a rate of $\frac{1}{80}$ of the job per minute. The sum of the fractions of the job that each can do individually in one minute equals the fraction of the job they can do working together. So we have

$\frac{1}{t} = \frac{1}{70} + \frac{1}{80} \Leftrightarrow 560 = 8t + 7t \Leftrightarrow 560 = 15t \Leftrightarrow t = 37\frac{1}{3}$ minutes. Since $\frac{1}{3}$ of a minute is 20 seconds, it would take them 37 minutes 20 seconds if they worked together.

56. Let t be the time, in minutes, it takes Hilda to mow the lawn. Since Hilda is twice as fast as Stan, it takes Stan $2t$ minutes to mow the lawn by himself. Thus $40 \cdot \frac{1}{t} + 40 \cdot \frac{1}{2t} = 1 \Leftrightarrow 40 + 20 = t \Leftrightarrow t = 60$. So it would take Stan $2(60) = 120$ minutes to mow the lawn.

57. Let t be the time, in hours, it takes Karen to paint a house alone. Then working together, Karen and Betty can paint a house in $\frac{2}{3}t$ hours. The sum of their individual rates equals their rate working together, so $\frac{1}{t} + \frac{1}{6} = \frac{1}{\frac{2}{3}t} \Leftrightarrow \frac{1}{t} + \frac{1}{6} = \frac{3}{2t} \Leftrightarrow 6 + t = 9 \Leftrightarrow t = 3$. Thus it would take Karen 3 hours to paint a house alone.
58. Let h be the time, in hours, to fill the swimming pool using Jim's hose alone. Since Bob's hose takes 20% less time, it uses only 80% of the time, or $0.8h$. Thus $18 \cdot \frac{1}{h} + 18 \cdot \frac{1}{0.8h} = 1 \Leftrightarrow 18 \cdot 0.8 + 18 = 0.8h \Leftrightarrow 14.4 + 18 = 0.8h \Leftrightarrow 32.4 = 0.8h \Leftrightarrow h = 40.5$. Jim's hose takes 40.5 hours, and Bob's hose takes 32.4 hours to fill the pool alone.
59. Let t be the time in hours that Wendy spent on the train. Then $\frac{11}{2} - t$ is the time in hours that Wendy spent on the bus. We construct a table:

	Rate	Time	Distance
By train	40	t	$40t$
By bus	60	$\frac{11}{2} - t$	$60\left(\frac{11}{2} - t\right)$

- The total distance traveled is the sum of the distances traveled by bus and by train, so $300 = 40t + 60\left(\frac{11}{2} - t\right) \Leftrightarrow 300 = 40t + 330 - 60t \Leftrightarrow -30 = -20t \Leftrightarrow t = \frac{-30}{-20} = 1.5$ hours. So the time spent on the train is $5.5 - 1.5 = 4$ hours.
60. Let r be the speed of the slower cyclist, in mi/h. Then the speed of the faster cyclist is $2r$.

	Rate	Time	Distance
Slower cyclist	r	2	$2r$
Faster cyclist	$2r$	2	$4r$

- When they meet, they will have traveled a total of 90 miles, so $2r + 4r = 90 \Leftrightarrow 6r = 90 \Leftrightarrow r = 15$. The speed of the slower cyclist is 15 mi/h, while the speed of the faster cyclist is $2(15) = 30$ mi/h.
61. Let r be the speed of the plane from Montreal to Los Angeles. Then $r + 0.20r = 1.20r$ is the speed of the plane from Los Angeles to Montreal.

	Rate	Time	Distance
Montreal to L.A.	r	$\frac{2500}{r}$	2500
L.A. to Montreal	$1.2r$	$\frac{2500}{1.2r}$	2500

- The total time is the sum of the times each way, so $9\frac{1}{6} = \frac{2500}{r} + \frac{2500}{1.2r} \Leftrightarrow \frac{55}{6} = \frac{2500}{r} + \frac{2500}{1.2r} \Leftrightarrow 55 \cdot 1.2r = 2500 \cdot 6 \cdot 1.2 + 2500 \cdot 6 \Leftrightarrow 66r = 18,000 + 15,000 \Leftrightarrow 66r = 33,000 \Leftrightarrow r = \frac{33,000}{66} = 500$. Thus the plane flew at a speed of 500 mi/h on the trip from Montreal to Los Angeles.
62. Let x be the speed of the car in mi/h. Since a mile contains 5280 ft and an hour contains 3600 s, $1 \text{ mi/h} = \frac{5280 \text{ ft}}{3600 \text{ s}} = \frac{22}{15} \text{ ft/s}$. The truck is traveling at $50 \cdot \frac{22}{15} = \frac{220}{3} \text{ ft/s}$. So in 6 seconds, the truck travels $6 \cdot \frac{220}{3} = 440$ feet. Thus the back end of the car must travel the length of the car, the length of the truck, and the 440 feet in 6 seconds, so its speed must be $\frac{14+30+440}{6} = \frac{242}{3} \text{ ft/s}$. Converting to mi/h, we have that the speed of the car is $\frac{242}{3} \cdot \frac{15}{22} = 55 \text{ mi/h}$.
63. Let x be the distance from the fulcrum to where the mother sits. Then substituting the known values into the formula given, we have $100(8) = 125x \Leftrightarrow 800 = 125x \Leftrightarrow x = 6.4$. So the mother should sit 6.4 feet from the fulcrum.
64. Let w be the largest weight that can be hung. In this exercise, the edge of the building acts as the fulcrum, so the 240 lb man is sitting 25 feet from the fulcrum. Then substituting the known values into the formula given in Exercise 43, we have $240(25) = 5w \Leftrightarrow 6000 = 5w \Leftrightarrow w = 1200$. Therefore, 1200 pounds is the largest weight that can be hung.

65. Let l be the length of the lot in feet. Then the length of the diagonal is $l + 10$. We apply the Pythagorean Theorem with the hypotenuse as the diagonal. So
- $$l^2 + 50^2 = (l + 10)^2 \Leftrightarrow l^2 + 2500 = l^2 + 20l + 100 \Leftrightarrow 20l = 2400 \Leftrightarrow l = 120.$$
- Thus the length of the lot is 120 feet.

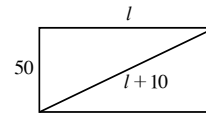

66. Let r be the radius of the running track. The running track consists of two semicircles and two straight sections 110 yards long, so we get the equation $2\pi r + 220 = 440 \Leftrightarrow 2\pi r = 220 \Leftrightarrow r = \frac{110}{\pi} \approx 35.03$. Thus the radius of the semicircle is about 35 yards.
67. Let h be the height in feet of the structure. The structure is composed of a right cylinder with radius 10 and height $\frac{2}{3}h$ and a cone with base radius 10 and height $\frac{1}{3}h$. Using the formulas for the volume of a cylinder and that of a cone, we obtain the equation $1400\pi = \pi(10)^2\left(\frac{2}{3}h\right) + \frac{1}{3}\pi(10)^2\left(\frac{1}{3}h\right) \Leftrightarrow 1400\pi = \frac{200\pi}{3}h + \frac{100\pi}{9}h \Leftrightarrow 126 = 6h + h$ (multiply both sides by $\frac{9}{100\pi}$) $\Leftrightarrow 126 = 7h \Leftrightarrow h = 18$. Thus the height of the structure is 18 feet.

68. Let h be the height of the break, in feet. Then the portion of the bamboo above the break is $10 - h$. Applying the Pythagorean Theorem, we obtain
- $$h^2 + 3^2 = (10 - h)^2 \Leftrightarrow h^2 + 9 = 100 - 20h + h^2 \Leftrightarrow -91 = -20h \Leftrightarrow h = \frac{91}{20} = 4.55.$$
- Thus the break is 4.55 ft above the ground.

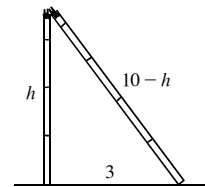

69. Pythagoras was born about 569 BC in Samos, Ionia and died about 475 BC.
Euclid was born about 325 BC and died about 265 BC in Alexandria, Egypt.
Archimedes was born in 287 BC in Syracuse, Sicily and died in 212 BC in Syracuse.
70. Answers will vary.

CHAPTER P REVIEW

- (a) Since there are initially 250 tablets and she takes 2 tablets per day, the number of tablets T that are left in the bottle after she has been taking the tablets for x days is $T = 250 - 2x$.

(b) After 30 days, there are $250 - 2(30) = 190$ tablets left.

(c) We set $T = 0$ and solve: $T = 250 - 2x = 0 \Leftrightarrow 250 = 2x \Leftrightarrow x = 125$. She will run out after 125 days.
- (a) The total cost is \$2 per calzone plus the \$3 delivery charge, so $C = 2x + 3$.

(b) 4 calzones would be $2(4) + 3 = \$11$.

(c) We solve $C = 2x + 3 = 15 \Leftrightarrow 2x = 12 \Leftrightarrow x = 6$. You can order six calzones.
- (a) 16 is rational. It is an integer, and more precisely, a natural number.

(b) -16 is rational. It is an integer, but because it is negative, it is not a natural number.

(c) $\sqrt{16} = 4$ is rational. It is an integer, and more precisely, a natural number.

(d) $\sqrt{2}$ is irrational.

(e) $\frac{8}{3}$ is rational, but is neither a natural number nor an integer.

(f) $-\frac{8}{2} = -4$ is rational. It is an integer, but because it is negative, it is not a natural number.
- (a) -5 is rational. It is an integer, but not a natural number.

(b) $-\frac{25}{6}$ is rational, but is neither an integer nor a natural number.

(c) $\sqrt{25} = 5$ is rational, a natural number, and an integer.

(d) 3π is irrational.

(e) $\frac{24}{16} = \frac{3}{2}$ is rational, but is neither a natural number nor an integer.(f) 10^{20} is rational, a natural number, and an integer.

5. Commutative Property of addition.

7. Distributive Property.

9. (a) $\frac{5}{6} + \frac{2}{3} = \frac{5}{6} + \frac{4}{6} = \frac{9}{6} = \frac{3}{2}$

(b) $\frac{5}{6} - \frac{2}{3} = \frac{5}{6} - \frac{4}{6} = \frac{1}{6}$

11. (a) $\frac{15}{8} \cdot \frac{12}{5} = \frac{15 \cdot 12}{8 \cdot 5} = \frac{3 \cdot 3}{2 \cdot 1} = \frac{9}{2}$

(b) $\frac{15}{8} \div \frac{12}{5} = \frac{15 \cdot 5}{8 \cdot 12} = \frac{5 \cdot 5}{8 \cdot 4} = \frac{25}{32}$

13. $x \in [-2, 6) \Leftrightarrow -2 \leq x < 6$

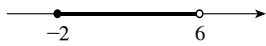

15. $x \in (-\infty, 4] \Leftrightarrow x \leq 4$

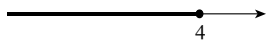

17. $x \geq 5 \Leftrightarrow x \in [5, \infty)$

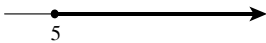

19. $-1 < x \leq 5 \Leftrightarrow x \in (-1, 5]$

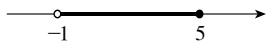

21. (a) $A \cup B = \{-1, 0, \frac{1}{2}, 1, 2, 3, 4\}$

(b) $A \cap B = \{1\}$

23. (a) $A \cap C = \{1, 2\}$

(b) $B \cap D = \{\frac{1}{2}, 1\}$

25. $|7 - 10| = |-3| = 3$

27. $2^{1/2} 8^{1/2} = \sqrt{2} \cdot \sqrt{8} = \sqrt{16} = 4$

29. $216^{-1/3} = \frac{1}{216^{1/3}} = \frac{1}{\sqrt[3]{216}} = \frac{1}{6}$

31. $\frac{\sqrt{242}}{\sqrt{2}} = \sqrt{\frac{242}{2}} = \sqrt{121} = 11$

33. (a) $|5 - 3| = |2| = 2$

(b) $|-5 - 3| = |-8| = 8$

6. Commutative Property of multiplication.

8. Distributive Property.

10. (a) $\frac{7}{10} - \frac{11}{15} = \frac{21}{30} - \frac{22}{30} = -\frac{1}{30}$

(b) $\frac{7}{10} + \frac{11}{15} = \frac{21}{30} + \frac{22}{30} = \frac{43}{30}$

12. (a) $\frac{30}{7} \div \frac{12}{35} = \frac{30 \cdot 35}{7 \cdot 12} = \frac{5 \cdot 5}{1 \cdot 2} = \frac{25}{2}$

(b) $\frac{30}{7} \cdot \frac{12}{35} = \frac{30 \cdot 12}{7 \cdot 35} = \frac{6 \cdot 12}{7 \cdot 7} = \frac{72}{49}$

14. $x \in (0, 10] \Leftrightarrow 0 < x \leq 10$

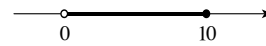

16. $x \in [-2, \infty) \Leftrightarrow -2 \leq x$

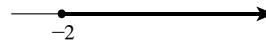

18. $x < -3 \Leftrightarrow x \in (-\infty, -3)$

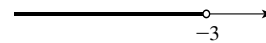

20. $0 \leq x \leq \frac{1}{2} \Leftrightarrow x \in [0, \frac{1}{2}]$

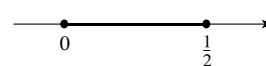

22. (a) $C \cup D = (-1, 2]$

(b) $C \cap D = (0, 1]$

24. (a) $A \cap D = \{0, 1\}$

(b) $B \cap C = \{\frac{1}{2}, 1\}$

26. $|3 - |-9|| = |3 - 9| = |-6| = 6$

28. $2^{-3} - 3^{-2} = \frac{1}{8} - \frac{1}{9} = \frac{9}{72} - \frac{8}{72} = \frac{1}{72}$

30. $64^{2/3} = (4^3)^{2/3} = 4^2 = 16$

32. $\sqrt{2} \sqrt{50} = \sqrt{100} = 10$

34. (a) $|-4 - 0| = |-4| = 4$

(b) $|-4 - 4| = |-8| = 8$

35. (a) $\sqrt[3]{7} = 7^{1/3}$

(b) $\sqrt[5]{7^4} = 7^{4/5}$

37. (a) $\sqrt[6]{x^5} = x^{5/6}$

(b) $(\sqrt{x})^9 = (x^{1/2})^9 = x^{9/2}$

39. $(2x^3y)^2(3x^{-1}y^2) = 4x^6y^2 \cdot 3x^{-1}y^2 = 4 \cdot 3x^{6-1}y^{2+2}$
 $= 12x^5y^4$

41. $\frac{x^4(3x)^2}{x^3} = \frac{x^4 \cdot 9x^2}{x^3} = 9x^{4+2-3} = 9x^3$

43. $\sqrt[3]{(x^3y)^2y^4} = \sqrt[3]{x^6y^4y^2} = \sqrt[3]{x^6y^6} = x^2y^2$

45. $\frac{8r^{1/2}s^{-3}}{2r^{-2}s^4} = 4r^{(1/2)-(-2)}s^{-3-4} = 4r^{5/2}s^{-7} = \frac{4r^{5/2}}{s^7}$

46. $\left(\frac{ab^2c^{-3}}{2a^3b^{-4}}\right)^{-2} = \frac{a^{-2}b^{-4}c^6}{2^{-2}a^{-6}b^8} = 2^2a^{-2-(-6)}b^{-4-8}c^6 = 4a^4b^{-12}c^6 = \frac{4a^4c^6}{b^{12}}$

47. $78,250,000,000 = 7.825 \times 10^{10}$

48. $2.08 \times 10^{-8} = 0.0000000208$

49. $\frac{ab}{c} \approx \frac{(0.00000293)(1.582 \times 10^{-14})}{2.8064 \times 10^{12}} = \frac{(2.93 \times 10^{-6})(1.582 \times 10^{-14})}{2.8064 \times 10^{12}} = \frac{2.93 \cdot 1.582}{2.8064} \times 10^{-6-14-12}$
 $\approx 1.65 \times 10^{-32}$

50. $\frac{\text{times}}{\text{minute}} \cdot \frac{60 \text{ minutes}}{\text{hour}} \cdot \frac{24 \text{ hours}}{\text{day}} \cdot \frac{365 \text{ days}}{\text{year}} \cdot 90 \text{ years} \approx 3.8 \times 10^9 \text{ times}$

51. $2x^2y - 6xy^2 = 2xy(x - 3y)$

52. $12x^2y^4 - 3xy^5 + 9x^3y^2 = 3xy^2(4xy^2 - y^3 + 3x^2)$

53. $x^2 + 5x - 14 = (x + 7)(x - 2)$

54. $x^4 + x^2 - 2 = (x^2)^2 + x^2 - 2 = (x^2 + 2)(x^2 - 1) = (x^2 + 2)(x + 1)(x - 1)$

55. $3x^2 - 2x - 1 = (3x + 1)(x - 1)$

56. $6x^2 + x - 12 = (3x - 4)(2x + 3)$

57. $4t^2 - 13t - 12 = (4t + 3)(t - 4)$

58. $x^4 - 2x^2 + 1 = (x^2 - 1)^2 = [(x - 1)(x + 1)]^2 = (x - 1)^2(x + 1)^2$

59. $16 - 4t^2 = 4(4 - t^2) = -4(t + 2)(t - 2)$

60. $2y^6 - 32y^2 = 2y^2(y^4 - 16) = 2y^2(y^2 + 4)(y^2 - 4) = 2y^2(y^2 + 4)(y + 2)(y - 2)$

61. $x^6 - 1 = (x^3 - 1)(x^3 + 1) = (x - 1)(x^2 + x + 1)(x + 1)(x^2 - x + 1)$

62. $a^4b^2 + ab^5 = ab^2(a^3 + b^3) = ab^2(a + b)(a^2 - ab + b^2)$

63. $x^3 - 27 = (x - 3)(x^2 + 3x + 9)$

64. $3y^3 - 81x^3 = 3(y^3 - 27x^3) = 3(y - 3x)(y^2 + 3xy + 9x^2)$

36. (a) $\sqrt[3]{5^7} = 5^{7/3}$

(b) $(\sqrt[4]{5})^3 = (5^{1/4})^3 = 5^{3/4}$

38. (a) $\sqrt{y^3} = (y^3)^{1/2} = y^{3/2}$

(b) $(\sqrt[8]{y})^2 = (y^{1/8})^2 = y^{1/4}$

40. $(a^2)^{-3}(a^3b)^2(b^3)^4 = a^{-6} \cdot a^6b^2 \cdot b^{12}$
 $= a^{-6+6}b^{2+12} = b^{14}$

42. $\left(\frac{r^2s^{4/3}}{r^{1/3}s}\right)^6 = \frac{r^{12}s^8}{r^2s^6} = r^{12-2}s^{8-6} = r^{10}s^2$

44. $\sqrt{x^2y^4} = \sqrt{x^2} \cdot \sqrt{(y^2)^2} = |x|y^2$

$$65. 4x^3 - 8x^2 + 3x - 6 = 4x^2(x - 2) + 3(x - 2) = (4x^2 + 3)(x - 2)$$

$$66. 3x^3 - 2x^2 + 18x - 12 = x^2(3x - 2) + 6(3x - 2) = (3x - 2)(x^2 + 6)$$

$$67. (x + y)^2 - 7(x + y) + 6 = [(x + y) - 6][(x + y) - 1] = (x + y - 6)(x + y + 1)$$

$$68. (a + b)^2 - 3(a + b) - 10 = (a + b - 5)(a + b + 2)$$

$$69. (2y - 7)(2y + 7) = 4y^2 - 49$$

$$70. (1 + x)(2 - x) - (3 - x)(3 + x) = 2 + x - x^2 - (9 - x^2) = 2 + x - x^2 - 9 + x^2 = -7 + x$$

$$71. x^2(x - 2) + x(x - 2)^2 = x^3 - 2x^2 + x(x^2 - 4x + 4) = x^3 - 2x^2 + x^3 - 4x^2 + 4x = 2x^3 - 6x^2 + 4x$$

$$72. \frac{x^3 + 2x^2 + 3x}{x} = \frac{x(x^2 + 2x + 3)}{x} = x^2 + 2x + 3$$

$$73. \sqrt{x}(\sqrt{x} + 1)(2\sqrt{x} - 1) = (x + \sqrt{x})(2\sqrt{x} - 1) = 2x\sqrt{x} - x + 2x - \sqrt{x} = 2x\sqrt{x} + x - \sqrt{x}$$

$$74. (2x + 1)^3 = (2x)^3 + 3(2x)^2(1) + 3(2x)(1)^2 + (1)^3 = 8x^3 + 12x^2 + 6x + 1$$

$$75. \frac{x^2 - 2x - 3}{2x^2 + 5x + 3} = \frac{(x - 3)(x + 1)}{(2x + 3)(x + 1)} = \frac{x - 3}{2x + 3}$$

$$76. \frac{t^3 - 1}{t^2 - 1} = \frac{(t - 1)(t^2 + t + 1)}{(t - 1)(t + 1)} = \frac{t^2 + t + 1}{t + 1}$$

$$77. \frac{x^2 + 2x - 3}{x^2 + 8x + 16} \cdot \frac{3x + 12}{x - 1} = \frac{(x + 3)(x - 1)}{(x + 4)(x + 4)} \cdot \frac{3(x + 4)}{(x - 1)} = \frac{3(x + 3)}{x + 4}$$

$$78. \frac{x^2 - 2x - 15}{x^2 - 6x + 5} \div \frac{x^2 - x - 12}{x^2 - 1} = \frac{(x - 5)(x + 3)}{(x - 5)(x - 1)} \cdot \frac{(x - 1)(x + 1)}{(x - 4)(x + 3)} = \frac{x + 1}{x - 4}$$

$$79. x - \frac{1}{x + 1} = \frac{x(x + 1)}{x + 1} - \frac{1}{x + 1} = \frac{x^2 + x - 1}{x + 1}$$

$$80. \frac{1}{x - 1} - \frac{x}{x^2 + 1} = \frac{x^2 + 1}{(x - 1)(x^2 + 1)} - \frac{x(x - 1)}{(x - 1)(x^2 + 1)} = \frac{x^2 + 1 - x^2 + x}{(x - 1)(x^2 + 1)} = \frac{x + 1}{(x - 1)(x^2 + 1)}$$

$$81. \frac{2}{x} + \frac{1}{x - 2} + \frac{3}{(x - 2)^2} = \frac{2(x - 2)^2}{x(x - 2)^2} + \frac{x(x - 2)}{x(x - 2)^2} + \frac{3x}{x(x - 2)^2}$$

$$= \frac{2(x^2 - 4x + 4) + x^2 - 2x + 3x}{x(x - 2)^2} = \frac{2x^2 - 8x + 8 + x^2 - 2x + 3x}{x(x - 2)^2} = \frac{3x^2 - 7x + 8}{x(x - 2)^2}$$

$$82. \frac{1}{x + 2} + \frac{1}{x^2 - 4} - \frac{2}{x^2 - x - 2} = \frac{1}{x + 2} + \frac{1}{(x - 2)(x + 2)} - \frac{2}{(x - 2)(x + 1)}$$

$$= \frac{(x - 2)(x + 1)}{(x - 2)(x + 1)(x + 2)} + \frac{x + 1}{(x - 2)(x + 1)(x + 2)} - \frac{2(x + 2)}{(x - 2)(x + 1)(x + 2)}$$

$$= \frac{x^2 - x - 2 + x + 1 - 2x - 4}{(x - 2)(x + 1)(x + 2)} = \frac{x^2 - 2x - 5}{(x - 2)(x + 1)(x + 2)}$$

$$83. \frac{\frac{1}{x} - \frac{1}{2}}{x - 2} = \frac{\frac{2}{2x} - \frac{x}{2x}}{x - 2} = \frac{2 - x}{2x} \cdot \frac{1}{x - 2} = \frac{-1(x - 2)}{2x} \cdot \frac{1}{x - 2} = \frac{-1}{2x}$$

$$84. \frac{\frac{1}{x} - \frac{1}{x + 1}}{\frac{1}{x} + \frac{1}{x + 1}} = \frac{\frac{1}{x} - \frac{1}{x + 1}}{\frac{1}{x} + \frac{1}{x + 1}} \cdot \frac{x(x + 1)}{x(x + 1)} = \frac{(x + 1) - x}{(x + 1) + x} = \frac{1}{2x + 1}$$

$$85. \frac{3(x+h)^2 - 5(x+h) - (3x^2 - 5x)}{h} = \frac{3x^2 + 6xh + 3h^2 - 5x - 5h - 3x^2 + 5x}{h} = \frac{6xh + 3h^2 - 5h}{h}$$

$$= \frac{h(6x + 3h - 5)}{h} = 6x + 3h - 5$$

$$86. \frac{\sqrt{x+h} - \sqrt{x}}{h} = \frac{\sqrt{x+h} - \sqrt{x}}{h} \cdot \frac{\sqrt{x+h} + \sqrt{x}}{\sqrt{x+h} + \sqrt{x}} = \frac{(x+h) - x}{h(\sqrt{x+h} + \sqrt{x})} = \frac{h}{h(\sqrt{x+h} + \sqrt{x})} = \frac{1}{\sqrt{x+h} + \sqrt{x}}$$

$$87. \frac{1}{\sqrt{11}} = \frac{1}{\sqrt{11}} \cdot \frac{\sqrt{11}}{\sqrt{11}} = \frac{\sqrt{11}}{11}$$

$$88. \frac{3}{\sqrt{6}} = \frac{3}{\sqrt{6}} \cdot \frac{\sqrt{6}}{\sqrt{6}} = \frac{3\sqrt{6}}{6} = \frac{\sqrt{6}}{2}$$

$$89. \frac{10}{\sqrt{2}-1} = \frac{10}{\sqrt{2}-1} \cdot \frac{\sqrt{2}+1}{\sqrt{2}+1} = \frac{10+10\sqrt{2}}{2-1} = 10+10\sqrt{2}$$

$$90. \frac{14}{3-\sqrt{2}} = \frac{14}{3-\sqrt{2}} \cdot \frac{3+\sqrt{2}}{3+\sqrt{2}} = \frac{42+14\sqrt{2}}{3^2 - (\sqrt{2})^2} = \frac{42+14\sqrt{2}}{7} = 6+2\sqrt{2}$$

$$91. \frac{x}{2+\sqrt{x}} = \frac{x}{2+\sqrt{x}} \cdot \frac{2-\sqrt{x}}{2-\sqrt{x}} = \frac{2x-x\sqrt{x}}{2^2 - (\sqrt{x})^2} = \frac{x(\sqrt{x}-2)}{x-4}$$

$$92. \frac{\sqrt{x}-2}{\sqrt{x}+2} = \frac{\sqrt{x}-2}{\sqrt{x}+2} \cdot \frac{\sqrt{x}-2}{\sqrt{x}-2} = \frac{x-4\sqrt{x}+4}{x-4}$$

93. $\frac{x+5}{x+10}$ is defined whenever $x+10 \neq 0 \Leftrightarrow x \neq -10$, so its domain is $\{x \mid x \neq -10\}$.

94. $\frac{2x}{x^2-9}$ is defined whenever $x^2-9 \neq 0 \Leftrightarrow x^2 \neq 9 \Leftrightarrow x \neq \pm 3$, so its domain is $\{x \mid x \neq -3 \text{ and } x \neq 3\}$.

95. $\frac{\sqrt{x}}{x^2-3x-4}$ is defined whenever $x \geq 0$ (so that \sqrt{x} is defined) and $x^2-3x-4 = (x+1)(x-4) \neq 0 \Leftrightarrow x \neq -1$ and $x \neq 4$. Thus, its domain is $\{x \mid x \geq 0 \text{ and } x \neq 4\}$.

96. $\frac{\sqrt{x-3}}{x^2-4x+4}$ is defined whenever $x-3 \geq 0 \Leftrightarrow x \geq 3$ and $x^2-4x+4 = (x-2)^2 \neq 0 \Leftrightarrow x \neq \pm 2$. Thus, its domain is $\{x \mid x \geq 3\}$.

97. This statement is false. For example, take $x = 1$ and $y = 1$. Then LHS = $(x+y)^3 = (1+1)^3 = 2^3 = 8$, while RHS = $x^3 + y^3 = 1^3 + 1^3 = 1+1 = 2$, and $8 \neq 2$.

98. This statement is true for $a \neq 1$: $\frac{1+\sqrt{a}}{1-a} = \frac{1+\sqrt{a}}{1-a} \cdot \frac{1-\sqrt{a}}{1-\sqrt{a}} = \frac{1-a}{(1-a)(1-\sqrt{a})} = \frac{1}{1-\sqrt{a}}$.

99. This statement is true: $\frac{12+y}{y} = \frac{12}{y} + \frac{y}{y} = \frac{12}{y} + 1$.

100. This statement is false. For example, take $a = 1$ and $b = 1$. Then LHS = $\sqrt[3]{a+b} = \sqrt[3]{1+1} = \sqrt[3]{2}$, while RHS = $\sqrt[3]{a} + \sqrt[3]{b} = \sqrt[3]{1} + \sqrt[3]{1} = 1+1 = 2$, and $\sqrt[3]{2} \neq 2$.

101. This statement is false. For example, take $a = -1$. Then LHS = $\sqrt{a^2} = \sqrt{(-1)^2} = \sqrt{1} = 1$, which does not equal $a = -1$. The true statement is $\sqrt{a^2} = |a|$.

102. This statement is false. For example, take $x = 1$. Then LHS = $\frac{1}{x+4} = \frac{1}{1+4} = \frac{1}{5}$, while RHS = $\frac{1}{x} + \frac{1}{4} = \frac{1}{1} + \frac{1}{4} = \frac{5}{4}$, and $\frac{1}{5} \neq \frac{5}{4}$.

103. $3x+12=24 \Leftrightarrow 3x=12 \Leftrightarrow x=4$

104. $5x-7=42 \Leftrightarrow 5x=49 \Leftrightarrow x=\frac{49}{5}$

105. $7x - 6 = 4x + 9 \Leftrightarrow 3x = 15 \Leftrightarrow x = 5$ 106. $8 - 2x = 14 + x \Leftrightarrow -3x = 6 \Leftrightarrow x = -2$
107. $\frac{1}{3}x - \frac{1}{2} = 2 \Leftrightarrow 2x - 3 = 12 \Leftrightarrow 2x = 15 \Leftrightarrow x = \frac{15}{2}$
108. $\frac{2}{3}x + \frac{3}{5} = \frac{1}{5} - 2x \Leftrightarrow 10x + 9 = 3 - 30x \Leftrightarrow 40x = -6 \Leftrightarrow x = -\frac{6}{40} = -\frac{3}{20}$
109. $2(x + 3) - 4(x - 5) = 8 - 5x \Leftrightarrow 2x + 6 - 4x + 20 = 8 - 5x \Leftrightarrow -2x + 26 = 8 - 5x \Leftrightarrow 3x = -18 \Leftrightarrow x = -6$
110. $\frac{x-5}{2} - \frac{2x+5}{3} = \frac{5}{6} \Leftrightarrow 3(x-5) - 2(2x+5) = 5 \Leftrightarrow 3x - 15 - 4x - 10 = 5 \Leftrightarrow -x = 30 \Leftrightarrow x = -30$
111. $\frac{x+1}{x-1} = \frac{2x-1}{2x+1} \Leftrightarrow (x+1)(2x+1) = (2x-1)(x-1) \Leftrightarrow 2x^2 + 3x + 1 = 2x^2 - 3x + 1 \Leftrightarrow 6x = 0 \Leftrightarrow x = 0$
112. $\frac{x}{x+2} - 3 = \frac{1}{x+2} \Leftrightarrow x - 3(x+2) = 1 \Leftrightarrow x - 3x - 6 = 1 \Leftrightarrow -2x = 7 \Leftrightarrow x = -\frac{7}{2}$
113. $\frac{x+1}{x-1} = \frac{3x}{3x-6} = \frac{3x}{3(x-2)} = \frac{x}{x-2} \Leftrightarrow (x+1)(x-2) = x(x-1) \Leftrightarrow x^2 - x - 2 = x^2 - x \Leftrightarrow -2 = 0$. Since this last equation is never true, there is no real solution to the original equation.
114. $(x+2)^2 = (x-4)^2 \Leftrightarrow (x+2)^2 - (x-4)^2 = 0 \Leftrightarrow [(x+2) - (x-4)][(x+2) + (x-4)] = 0 \Leftrightarrow [x+2-x+4][x+2+x-4] = 6(2x-2) = 0 \Leftrightarrow 2x-2 = 0 \Leftrightarrow x = 1$.
115. $x^2 = 144 \Rightarrow x = \pm 12$
116. $4x^2 = 49 \Leftrightarrow x^2 = \frac{49}{4} \Rightarrow x = \pm \frac{7}{2}$
117. $x^3 - 27 = 0 \Leftrightarrow x^3 = 27 \Rightarrow x = 3$.
118. $6x^4 + 15 = 0 \Leftrightarrow 6x^4 = -15 \Leftrightarrow x^4 = -\frac{5}{2}$. Since x^4 must be nonnegative, there is no real solution.
119. $(x+1)^3 = -64 \Leftrightarrow x+1 = -4 \Leftrightarrow x = -1-4 = -5$.
120. $(x+2)^2 - 2 = 0 \Leftrightarrow (x+2)^2 = 2 \Leftrightarrow x+2 = \pm\sqrt{2} \Leftrightarrow x = -2 \pm \sqrt{2}$.
121. $\sqrt[3]{x} = -3 \Leftrightarrow x = (-3)^3 = -27$.
122. $x^{2/3} - 4 = 0 \Leftrightarrow (x^{1/3})^2 = 4 \Rightarrow x^{1/3} = \pm 2 \Leftrightarrow x = \pm 8$.
123. $4x^{3/4} - 500 = 0 \Leftrightarrow 4x^{3/4} = 500 \Leftrightarrow x^{3/4} = 125 \Leftrightarrow x = 125^{4/3} = 5^4 = 625$.
124. $(x-2)^{1/5} = 2 \Leftrightarrow x-2 = 2^5 = 32 \Leftrightarrow x = 2+32 = 34$.
125. $A = \frac{x+y}{2} \Leftrightarrow 2A = x+y \Leftrightarrow x = 2A - y$.
126. $V = xy + yz + xz \Leftrightarrow V = y(x+z) + xz \Leftrightarrow V - xz = y(x+z) \Leftrightarrow y = \frac{V-xz}{x+z}$.
127. Multiply through by t : $J = \frac{1}{t} + \frac{1}{2t} + \frac{1}{3t} \Leftrightarrow tJ = 1 + \frac{1}{2} + \frac{1}{3} = \frac{11}{6} \Leftrightarrow t = \frac{11}{6J}, J \neq 0$.
128. $F = k \frac{q_1 q_2}{r^2} \Leftrightarrow r^2 = k \frac{q_1 q_2}{F} \Leftrightarrow r = \pm \sqrt{k \frac{q_1 q_2}{F}}$. (In real-world applications, r represents distance, so we would take the positive root.)
129. Let x be the number of pounds of raisins. Then the number of pounds of nuts is $50 - x$.

	Raisins	Nuts	Mixture
Pounds	x	$50 - x$	50
Rate (cost per pound)	3.20	2.40	2.72

So $3.20x + 2.40(50 - x) = 2.72(50) \Leftrightarrow 3.20x + 120 - 2.40x = 136 \Leftrightarrow 0.8x = 16 \Leftrightarrow x = 20$. Thus the mixture uses 20 pounds of raisins and $50 - 20 = 30$ pounds of nuts.

130. Let t be the number of hours that Anthony drives. Then Helen drives for $t - \frac{1}{4}$ hours.

	Rate	Time	Distance
Anthony	45	t	$45t$
Helen	40	$t - \frac{1}{4}$	$40\left(t - \frac{1}{4}\right)$

When they pass each other, they will have traveled a total of 160 miles. So $45t + 40\left(t - \frac{1}{4}\right) = 160 \Leftrightarrow 45t + 40t - 10 = 160 \Leftrightarrow 85t = 170 \Leftrightarrow t = 2$. Since Anthony leaves at 2:00 P.M. and travels for 2 hours, they pass each other at 4:00 P.M.

131. Let x be the amount invested in the account earning 1.5% interest. Then the amount invested in the account earning 2.5% is $7000 - x$.

	1.5% Account	2.5% Account	Total
Amount invested	x	$7000 - x$	7000
Interest earned	$0.015x$	$0.025(7000 - x)$	120.25

From the table, we see that $0.015x + 0.025(7000 - x) = 120.25 \Leftrightarrow 0.015x + 175 - 0.025x = 120.25 \Leftrightarrow 54.75 = 0.01x \Leftrightarrow x = 5475$. Thus, Luc invested \$5475 in the account earning 1.5% interest and \$1525 in the account earning 2.5% interest.

132. The amount of interest Shania is currently earning is $6000(0.03) = \$180$. If she wishes to earn a total of \$300, she must earn another \$120 in interest at a rate of 1.25% per year. If the additional amount invested is x , we have the equation $0.0125x = 120 \Leftrightarrow x = 9600$. Thus, Shania must invest an additional \$9600 at 1.25% simple interest to earn a total of \$300 interest per year.
133. Let t be the time it would take Abbie to paint a living room if she works alone. It would take Beth $2t$ hours to paint the living room alone, and it would take $3t$ hours for Cathie to paint the living room. Thus Abbie does $\frac{1}{t}$ of the job per hour, Beth does $\frac{1}{2t}$ of the job per hour, and Cathie does $\frac{1}{3t}$ of the job per hour. So $\frac{1}{t} + \frac{1}{2t} + \frac{1}{3t} = 1 \Leftrightarrow 6 + 3 + 2 = 6t \Leftrightarrow 6t = 11 \Leftrightarrow t = \frac{11}{6}$. So it would Abbie 1 hour 50 minutes to paint the living room alone.
134. Let w be width of the pool. Then the length of the pool is $2w$, and its volume is $8(w)(2w) = 8464 \Leftrightarrow 16w^2 = 8464 \Leftrightarrow w^2 = 529 \Rightarrow w = \pm 23$. Since $w > 0$, we reject the negative value. The pool is 23 feet wide, $2(23) = 46$ feet long, and 8 feet deep.

CHAPTER P TEST

1. (a) The cost is $C = 9 + 1.5x$.
 (b) There are four extra toppings, so $x = 4$ and $C = 9 + 1.5(4) = \$15$.
2. (a) 5 is rational. It is an integer, and more precisely, a natural number.
 (b) $\sqrt{5}$ is irrational.
 (c) $-\frac{9}{3} = -3$ is rational, and it is an integer.
 (d) $-1,000,000$ is rational, and it is an integer.
3. (a) $A \cap B = \{0, 1, 5\}$
 (b) $A \cup B = \left\{-2, 0, \frac{1}{2}, 1, 3, 5, 7\right\}$

4. (a)



$[-4, 2)$



$[0, 3]$

(b)



$$[-4, 2) \cap [0, 3] = [0, 2)$$

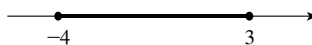

$$[-4, 2) \cup [0, 3] = [-4, 3]$$

(c) $| -4 - 2 | = | -6 | = 6$

5. (a) $-2^6 = -64$

(b) $(-2)^6 = 64$

(c) $2^{-6} = \frac{1}{2^6} = \frac{1}{64}$

(d) $\frac{7^{10}}{7^{12}} = 7^{-2} = \frac{1}{49}$

(e) $\left(\frac{3}{2}\right)^{-2} = \left(\frac{2}{3}\right)^2 = \frac{4}{9}$

(f) $\frac{\sqrt[5]{32}}{\sqrt{16}} = \frac{2}{4} = \frac{1}{2}$

(g) $\sqrt[4]{\frac{3^8}{2^{16}}} = \frac{3^2}{2^4} = \frac{9}{16}$

(h) $81^{-3/4} = (3^4)^{-3/4} = 3^{-3} = \frac{1}{27}$

6. (a) $186,000,000,000 = 1.86 \times 10^{11}$

(b) $0.0000003965 = 3.965 \times 10^{-7}$

7. (a) $\frac{a^3b^2}{ab^3} = \frac{a^2}{b}$

(b) $(2x^3y^{-2})^{-2} = \frac{y^4}{4x^6}$

(c) $(2x^{1/2}y^2)(3x^{1/4}y^{-1})^2 = 2 \cdot 3^2 x^{(1/2)+2(1/4)} y^{2+2(-1)} = 18x$

(d) $\sqrt{20} - \sqrt{125} = \sqrt{4 \cdot 5} - \sqrt{25 \cdot 5} = 2\sqrt{5} - 5\sqrt{5} = -3\sqrt{5}$

(e) $\sqrt{18x^3y^4} = \sqrt{9 \cdot 2 \cdot x^2 \cdot x \cdot (y^2)^2} = 3xy^2\sqrt{2x}$

(f) $\left(\frac{2x^2y}{x^{-3}y^{1/2}}\right)^{-2} = 2^{-2} x^{2(-2)-(-3)(-2)} y^{-2-(1/2)(-2)} = \frac{1}{4x^{10}y}$

8. (a) $3(x+6) + 4(2x-5) = 3x + 18 + 8x - 20 = 11x - 2$

(b) $(x+3)(4x-5) = 4x^2 - 5x + 12x - 15 = 4x^2 + 7x - 15$

(c) $(\sqrt{a} + \sqrt{b})(\sqrt{a} - \sqrt{b}) = (\sqrt{a})^2 - (\sqrt{b})^2 = a - b$

(d) $(2x+3)^2 = (2x)^2 + 2(2x)(3) + (3)^2 = 4x^2 + 12x + 9$

(e) $(x+2)^3 = (x)^3 + 3(x)^2(2) + 3(x)(2)^2 + (2)^3 = x^3 + 6x^2 + 12x + 8$

(f) $x^2(x-3)(x+3) = x^2(x^2-9) = x^4 - 9x^2$

9. (a) $4x^2 - 25 = (2x-5)(2x+5)$

(b) $2x^2 + 5x - 12 = (2x-3)(x+4)$

(c) $x^3 - 3x^2 - 4x + 12 = x^2(x-3) - 4(x-3) = (x-3)(x^2-4) = (x-3)(x-2)(x+2)$

(d) $x^4 + 27x = x(x^3 + 27) = x(x+3)(x^2-3x+9)$

(e) $(2x-y)^2 - 10(2x-y) + 25 = (2x-y)^2 - 2(5)(2x-y) + 5^2 = (2x-y-5)^2$

(f) $x^3y - 4xy = xy(x^2-4) = xy(x-2)(x+2)$

10. (a) $\frac{x^2+3x+2}{x^2-x-2} = \frac{(x+1)(x+2)}{(x+1)(x-2)} = \frac{x+2}{x-2}$

(b) $\frac{2x^2-x-1}{x^2-9} \cdot \frac{x+3}{2x+1} = \frac{(2x+1)(x-1)}{(x-3)(x+3)} \cdot \frac{x+3}{2x+1} = \frac{x-1}{x-3}$

(c) $\frac{x^2}{x^2-4} - \frac{x+1}{x+2} = \frac{x^2}{(x-2)(x+2)} - \frac{x+1}{x+2} = \frac{x^2}{(x-2)(x+2)} + \frac{-(x+1)(x-2)}{(x-2)(x+2)}$

$$= \frac{x^2 - (x^2 - x - 2)}{(x-2)(x+2)} = \frac{x+2}{(x-2)(x+2)} = \frac{1}{x-2}$$

$$(d) \frac{\frac{y-x}{x-y}}{\frac{1}{y}-\frac{1}{x}} = \frac{\frac{y-x}{x-y}}{\frac{1}{y}-\frac{1}{x}} \cdot \frac{xy}{xy} = \frac{y^2-x^2}{x-y} = \frac{(y-x)(y+x)}{x-y} = \frac{-(x-y)(y+x)}{x-y} = -(y+x)$$

$$11. (a) \frac{6}{\sqrt[3]{4}} = \frac{6}{\sqrt[3]{2^2}} = \frac{6}{\sqrt[3]{2^2}} \cdot \frac{\sqrt[3]{2}}{\sqrt[3]{2}} = \frac{6\sqrt[3]{2}}{2} = 3\sqrt[3]{2}$$

$$(b) \frac{\sqrt{10}}{\sqrt{5}-2} = \frac{\sqrt{10}}{\sqrt{5}-2} \cdot \frac{\sqrt{5}+2}{\sqrt{5}+2} = \frac{\sqrt{10}(\sqrt{5}+2)}{5-4} = \sqrt{50} + 2\sqrt{10} = 5\sqrt{2} + 2\sqrt{10}$$

$$(c) \frac{1}{1+\sqrt{x}} = \frac{1}{1+\sqrt{x}} \cdot \frac{1-\sqrt{x}}{1-\sqrt{x}} = \frac{1-\sqrt{x}}{1-x}$$

$$12. (a) 4x-3=2x+7 \Leftrightarrow 4x-2x=7-(-3) \Leftrightarrow 2x=10 \Leftrightarrow x=5.$$

$$(b) 8x^3 = -125 \Leftrightarrow \sqrt[3]{8x^3} = \sqrt[3]{-125} \Leftrightarrow 2x = -5 \Leftrightarrow x = -\frac{5}{2}.$$

$$(c) x^{2/3} - 64 = 0 \Leftrightarrow x^{2/3} = 64 \Leftrightarrow (x^{2/3})^{3/2} = 64^{3/2} \Leftrightarrow x = 8^3 = 512.$$

$$(d) \frac{x}{2x-5} = \frac{x+3}{2x-1} \Leftrightarrow x(2x-1) = (x+3)(2x-5) \Leftrightarrow 2x^2 - x = 2x^2 - 5x + 6x - 15 \Leftrightarrow -x = x - 15 \Leftrightarrow 2x = 15 \Leftrightarrow x = \frac{15}{2}.$$

$$(e) 3(x+1)^2 - 18 = 0 \Leftrightarrow 3(x+1)^2 = 18 \Leftrightarrow (x+1)^2 = 6 \Leftrightarrow x+1 = \pm\sqrt{6} \Leftrightarrow x = \pm\sqrt{6} - 1$$

$$13. E = mc^2 \Leftrightarrow \frac{E}{m} = c^2 \Leftrightarrow c = \sqrt{\frac{E}{m}}. \text{ (We take the positive root because } c \text{ represents the speed of light, which is positive.)}$$

14. Let d be the distance in km, between Bedingfield and Portsmouth.

Direction	Distance	Rate	Time
Bedingfield \rightarrow Portsmouth	d	100	$\frac{d}{100}$
Portsmouth \rightarrow Bedingfield	d	75	$\frac{d}{75}$

We have used time = $\frac{\text{distance}}{\text{rate}}$ to fill in the time column of the table. We are given that the sum of the times is 3.5 hours.

$$\text{Thus we get the equation } \frac{d}{100} + \frac{d}{75} = 3.5 \Leftrightarrow 300 \left(\frac{d}{100} + \frac{d}{75} \right) = 300(3.5) \Leftrightarrow 3d + 4d = 1050 \Leftrightarrow d = \frac{1050}{7} = 150 \text{ km.}$$

FOCUS ON MODELING Making the Best Decisions

1. (a) The total cost is $\left(\begin{array}{c} \text{cost of} \\ \text{copier} \end{array} \right) + \left(\begin{array}{c} \text{maintenance} \\ \text{cost} \end{array} \right) \left(\begin{array}{c} \text{number} \\ \text{of months} \end{array} \right) + \left(\begin{array}{c} \text{copy} \\ \text{cost} \end{array} \right) \left(\begin{array}{c} \text{number} \\ \text{of months} \end{array} \right)$. Each month the copy cost is $8000 \cdot 0.03 = 240$. Thus we get $C_1 = 5800 + 25n + 240n = 5800 + 265n$.

(b) In this case the cost is $\left(\begin{array}{c} \text{rental} \\ \text{cost} \end{array} \right) \left(\begin{array}{c} \text{number} \\ \text{of months} \end{array} \right) + \left(\begin{array}{c} \text{copy} \\ \text{cost} \end{array} \right) \left(\begin{array}{c} \text{number} \\ \text{of months} \end{array} \right)$. Each month the copy cost is $8000 \cdot 0.06 = 480$. Thus we get $C_2 = 95n + 480n = 575n$.

(c)

Years	n	Purchase	Rental
1	12	8,980	6,900
2	24	12,160	13,800
3	36	15,340	20,700
4	48	18,520	27,600
5	60	21,700	34,500
6	72	24,880	41,400

(d) The cost is the same when $C_1 = C_2$ are equal. So $5800 + 265n = 575n \Leftrightarrow 5800 = 310n \Leftrightarrow n \approx 18.71$ months.

2. (a) The cost of Plan 1 is $3 \cdot \left(\begin{array}{c} \text{daily} \\ \text{cost} \end{array} \right) + \left(\begin{array}{c} \text{cost per} \\ \text{mile} \end{array} \right) \left(\begin{array}{c} \text{number} \\ \text{of miles} \end{array} \right) = 3 \cdot 65 + 0.15x = 195 + 0.15x$.

The cost of Plan 2 is $3 \cdot \left(\begin{array}{c} \text{daily} \\ \text{cost} \end{array} \right) = 3 \cdot 90 = 270$.

(b) When $x = 400$, Plan 1 costs $195 + 0.15(400) = \$255$ and Plan 2 costs \$270, so Plan 1 is cheaper. When $x = 800$, Plan 1 costs $195 + 0.15(800) = \$315$ and Plan 2 costs \$270, so Plan 2 is cheaper.

(c) The cost is the same when $195 + 0.15x = 270 \Leftrightarrow 0.15x = 75 \Leftrightarrow x = 500$. So both plans cost \$270 when the businessman drives 500 miles.

3. (a) The total cost is $\left(\begin{array}{c} \text{setup} \\ \text{cost} \end{array} \right) + \left(\begin{array}{c} \text{cost per} \\ \text{tire} \end{array} \right) \left(\begin{array}{c} \text{number} \\ \text{of tires} \end{array} \right)$. So $C = 8000 + 22x$.

(b) The revenue is $\left(\begin{array}{c} \text{price per} \\ \text{tire} \end{array} \right) \left(\begin{array}{c} \text{number} \\ \text{of tires} \end{array} \right)$. So $R = 49x$.

(c) Profit = Revenue - Cost. So $P = R - C = 49x - (8000 + 22x) = 27x - 8000$.

(d) Break even is when profit is zero. Thus $27x - 8000 = 0 \Leftrightarrow 27x = 8000 \Leftrightarrow x \approx 296.3$. So they need to sell at least 297 tires to break even.

4. (a) *Option 1:* In this option the width is constant at 100. Let x be the increase in length. Then the additional area is width \times $\left(\begin{array}{c} \text{increase} \\ \text{in length} \end{array} \right) = 100x$. The cost is the sum of the costs of moving the old fence, and of installing the new one. The cost of moving is $\$6 \cdot 100 = \600 and the cost of installation is $2 \cdot 10 \cdot x = 20x$, so the total cost is $C = 20x + 600$. Solving for x , we get $C = 20x + 600 \Leftrightarrow 20x = C - 600 \Leftrightarrow x = \frac{C - 600}{20}$. Substituting in the area we have $A_1 = 100 \left(\frac{C - 600}{20} \right) = 5(C - 600) = 5C - 3,000$.

Option 2: In this option the length is constant at 180. Let y be the increase in the width. Then the additional area is length \times $\left(\begin{array}{c} \text{increase} \\ \text{in width} \end{array} \right) = 180y$. The cost of moving the old fence is $6 \cdot 180 = \$1080$ and the cost of installing the new one is $2 \cdot 10 \cdot y = 20y$, so the total cost is $C = 20y + 1080$. Solving for y , we get $C = 20y + 1080 \Leftrightarrow 20y = C - 1080 \Leftrightarrow y = \frac{C - 1080}{20}$. Substituting in the area we have $A_2 = 180 \left(\frac{C - 1080}{20} \right) = 9(C - 1080) = 9C - 9,720$.

(b)

Cost, C	Area gain A_1 from Option 1	Area gain A_2 from Option 2
\$1100	2,500 ft ²	180 ft ²
\$1200	3,000 ft ²	1,080 ft ²
\$1500	4,500 ft ²	3,780 ft ²
\$2000	7,000 ft ²	8,280 ft ²
\$2500	9,500 ft ²	12,780 ft ²
\$3000	12,000 ft ²	17,280 ft ²

(c) If the farmer has only \$1200, Option 1 gives him the greatest gain. If the farmer has only \$2000, Option 2 gives him the greatest gain.

5. (a) Design 1 is a square and the perimeter of a square is four times the length of a side. $24 = 4x$, so each side is $x = 6$ feet long. Thus the area is $6^2 = 36$ ft².

Design 2 is a circle with perimeter $2\pi r$ and area πr^2 . Thus we must solve $2\pi r = 24 \Leftrightarrow r = \frac{12}{\pi}$. Thus, the area is

$$\pi \left(\frac{12}{\pi} \right)^2 = \frac{144}{\pi} \approx 45.8 \text{ ft}^2. \text{ Design 2 gives the largest area.}$$

(b) In Design 1, the cost is \$3 times the perimeter p , so $120 = 3p$ and the perimeter is 40 feet. By part (a), each side is then $\frac{40}{4} = 10$ feet long. So the area is $10^2 = 100$ ft².

In Design 2, the cost is \$4 times the perimeter p . Because the perimeter is $2\pi r$, we get $120 = 4(2\pi r)$ so

$$r = \frac{120}{8\pi} = \frac{15}{\pi}. \text{ The area is } \pi r^2 = \pi \left(\frac{15}{\pi} \right)^2 = \frac{225}{\pi} \approx 71.6 \text{ ft}^2. \text{ Design 1 gives the largest area.}$$

6. (a) Plan 1: Tomatoes every year. Profit = acres \times (Revenue - cost) = $100(1600 - 300) = 130,000$. Then for n years the profit is $P_1 = 130,000n$.

(b) Plan 2: Soybeans followed by tomatoes. The profit for two years is Profit = acres \times

$$\left[\left(\begin{array}{c} \text{soybean} \\ \text{revenue} \end{array} \right) + \left(\begin{array}{c} \text{tomato} \\ \text{revenue} \end{array} \right) \right] = 100(1200 + 1600) = 280,000. \text{ Remember that no fertilizer is needed in this plan. Then for } 2k \text{ years, the profit is } P_2 = 280,000k.$$

(c) When $n = 10$, $P_1 = 130,000(10) = 1,300,000$. Since $2k = 10$ when $k = 5$, $P_2 = 280,000(5) = 1,400,000$. So Plan B is more profitable.

7. (a)

Data (GB)	Plan A	Plan B	Plan C
1	\$25	\$40	\$60
1.5	$25 + 5(2.00) = \$35$	$40 + 5(1.50) = \$47.50$	$60 + 5(1.00) = \$65$
2	$25 + 10(2.00) = \$45$	$40 + 10(1.50) = \$55$	$60 + 10(1.00) = \$70$
2.5	$25 + 15(2.00) = \$55$	$40 + 15(1.50) = \$62.50$	$60 + 15(1.00) = \$75$
3	$25 + 20(2.00) = \$65$	$40 + 20(1.50) = \$70$	$60 + 20(1.00) = \$80$
3.5	$25 + 25(2.00) = \$75$	$40 + 25(1.50) = \$77.50$	$60 + 25(1.00) = \$85$
4	$25 + 30(2.00) = \$85$	$40 + 30(1.50) = \$85$	$60 + 30(1.00) = \$90$

- (b) For Plan A: $C_A = 25 + 2(10x - 10) = 20x + 5$. For Plan B: $C_B = 40 + 1.5(10x - 10) = 15x + 25$. For Plan C: $C_C = 60 + 1(10x - 10) = 10x + 50$. Note that these equations are valid only for $x \geq 1$.
- (c) If Gwendolyn uses 2.2 GB, Plan A costs $25 + 12(2) = \$49$, Plan B costs $40 + 12(1.5) = \$58$, and Plan C costs $60 + 12(1) = \$72$.
If she uses 3.7 GB, Plan A costs $25 + 27(2) = \$79$, Plan B costs $40 + 27(1.5) = \$80.50$, and Plan C costs $60 + 27(1) = \$87$.
If she uses 4.9 GB, Plan A costs $25 + 39(2) = \$103$, Plan B costs $40 + 39(1.5) = \$98.50$, and Plan C costs $60 + 39(1) = \$99$.
- (d) (i) We set $C_A = C_B \Leftrightarrow 20x + 5 = 15x + 25 \Leftrightarrow 5x = 20 \Leftrightarrow x = 4$. Plans A and B cost the same when 4 GB are used.
(ii) We set $C_A = C_C \Leftrightarrow 20x + 5 = 10x + 50 \Leftrightarrow 10x = 45 \Leftrightarrow x = 4.5$. Plans A and C cost the same when 4.5 GB are used.
(iii) We set $C_B = C_C \Leftrightarrow 15x + 25 = 10x + 50 \Leftrightarrow 5x = 25 \Leftrightarrow x = 5$. Plans B and C cost the same when 5 GB are used.
8. (a) In this plan, Company A gets \$3.2 million and Company B gets \$3.2 million. Company A's investment is \$1.4 million, so they make a profit of $3.2 - 1.4 = \$1.8$ million. Company B's investment is \$2.6 million, so they make a profit of $3.2 - 2.6 = \$0.6$ million. So Company A makes three times the profit that Company B does, which is not fair.
- (b) The original investment is $1.4 + 2.6 = \$4$ million. So after giving the original investment back, they then share the profit of \$2.4 million. So each gets an additional \$1.2 million. So Company A gets a total of $1.4 + 1.2 = \$2.6$ million and Company B gets $2.6 + 1.2 = \$3.8$ million. So even though Company B invests more, they make the same profit as Company A, which is not fair.
- (c) The original investment is \$4 million, so Company A gets $\frac{1.4}{4} \cdot 6.4 = \2.24 million and Company B gets $\frac{2.6}{4} \cdot 6.4 = \4.16 million. This seems the fairest.

1 EQUATIONS AND GRAPHS

1.1 THE COORDINATE PLANE

1. The point that is 2 units to the left of the y -axis and 4 units above the x -axis has coordinates $(-2, 4)$.
2. If x is positive and y is negative, then the point (x, y) is in Quadrant IV.
3. The distance between the points (a, b) and (c, d) is $\sqrt{(c-a)^2 + (d-b)^2}$. So the distance between $(1, 2)$ and $(7, 10)$ is $\sqrt{(7-1)^2 + (10-2)^2} = \sqrt{6^2 + 8^2} = \sqrt{36 + 64} = \sqrt{100} = 10$.
4. The point midway between (a, b) and (c, d) is $\left(\frac{a+c}{2}, \frac{b+d}{2}\right)$. So the point midway between $(1, 2)$ and $(7, 10)$ is $\left(\frac{1+7}{2}, \frac{2+10}{2}\right) = \left(\frac{8}{2}, \frac{12}{2}\right) = (4, 6)$.
5. $A(5, 1)$, $B(1, 2)$, $C(-2, 6)$, $D(-6, 2)$, $E(-4, -1)$, $F(-2, 0)$, $G(-1, -3)$, $H(2, -2)$
6. Points A and B lie in Quadrant 1 and points E and G lie in Quadrant 3.
7. $(0, 5)$, $(-1, 0)$, $(-1, -2)$, and $\left(\frac{1}{2}, \frac{2}{3}\right)$
8. $(-5, 0)$, $(2, 0)$, $(2.6, -1.3)$, and $(-2.5, -3.5)$

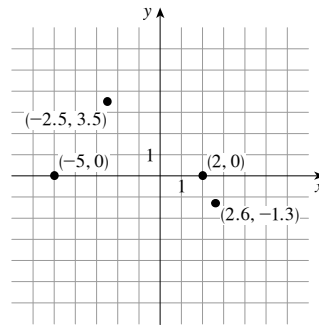
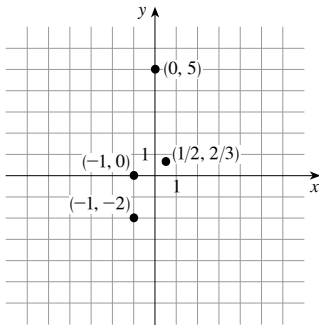

9. $\{(x, y) \mid x \geq 2\}$

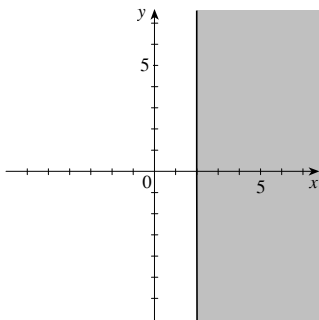

10. $\{(x, y) \mid y = 2\}$

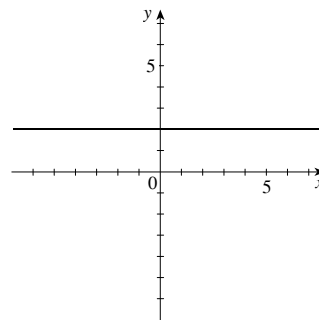

11. $\{(x, y) \mid x = -4\}$

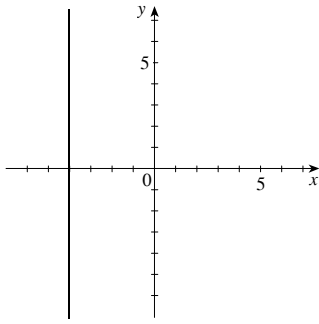

12. $\{(x, y) \mid y < 3\}$

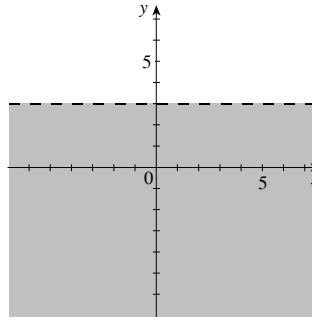

13. $\{(x, y) \mid -3 < x < 3\}$

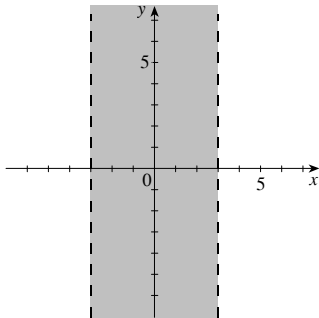

14. $\{(x, y) \mid 0 \leq y \leq 2\}$

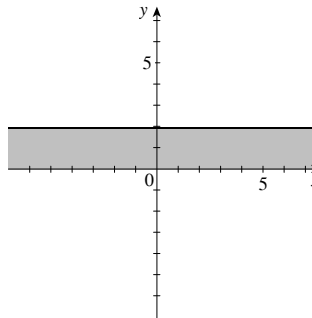

15. $\{(x, y) \mid xy < 0\}$

$= \{(x, y) \mid x < 0 \text{ and } y > 0 \text{ or } x > 0 \text{ and } y < 0\}$

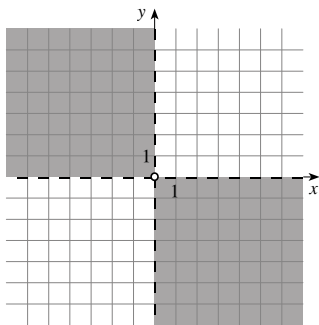

16. $\{(x, y) \mid xy > 0\}$

$= \{(x, y) \mid x < 0 \text{ and } y < 0 \text{ or } x > 0 \text{ and } y > 0\}$

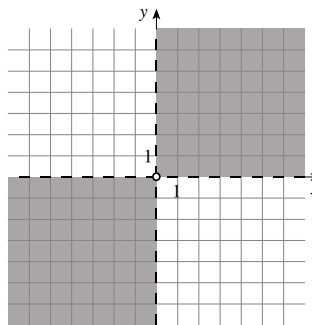

17. $\{(x, y) \mid x \geq 1 \text{ and } y < 3\}$

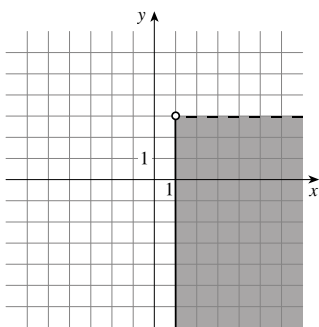

18. $\{(x, y) \mid x < 2 \text{ and } y \geq 1\}$

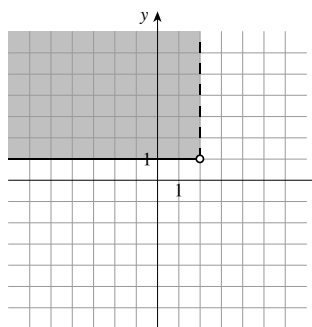

19. $\{(x, y) \mid -1 < x < 1 \text{ and } -2 < y < 2\}$

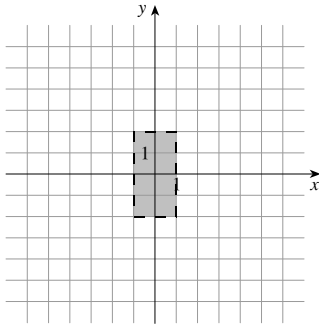

20. $\{(x, y) \mid -3 \leq x \leq 3 \text{ and } -1 \leq y \leq 1\}$

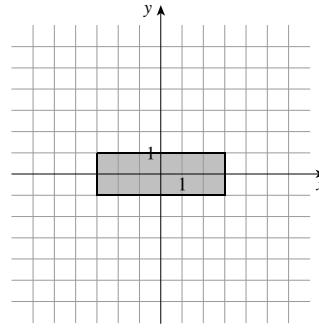
21. The two points are $(0, 2)$ and $(3, 0)$.

(a) $d = \sqrt{(3-0)^2 + (0-2)^2} = \sqrt{3^2 + 2^2} = \sqrt{9+4} = \sqrt{13}$

(b) midpoint: $\left(\frac{3+0}{2}, \frac{0+2}{2}\right) = \left(\frac{3}{2}, 1\right)$

22. The two points are $(-2, -1)$ and $(2, 2)$.

(a) $d = \sqrt{(-2-2)^2 + (-1-2)^2} = \sqrt{(-4)^2 + (-3)^2} = \sqrt{16+9} = \sqrt{25} = 5$

(b) midpoint: $\left(\frac{-2+2}{2}, \frac{-1+2}{2}\right) = \left(0, \frac{1}{2}\right)$

23. The two points are $(-3, 3)$ and $(5, -3)$.

(a) $d = \sqrt{(-3-5)^2 + (3-(-3))^2} = \sqrt{(-8)^2 + 6^2} = \sqrt{64+36} = \sqrt{100} = 10$

(b) midpoint: $\left(\frac{-3+5}{2}, \frac{3+(-3)}{2}\right) = (1, 0)$

24. The two points are $(-2, -3)$ and $(4, -1)$.

(a) $d = \sqrt{(-2-4)^2 + (-3-(-1))^2} = \sqrt{(-6)^2 + (-2)^2} = \sqrt{36+4} = \sqrt{40} = 2\sqrt{10}$

(b) midpoint: $\left(\frac{-2+4}{2}, \frac{-3+(-1)}{2}\right) = (1, -2)$

25. (a)

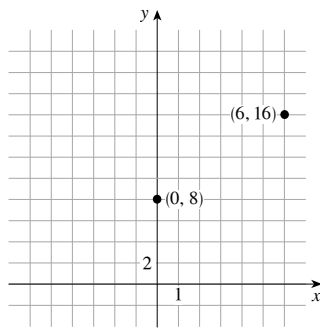

(b) $d = \sqrt{(0-6)^2 + (8-16)^2}$
 $= \sqrt{(-6)^2 + (-8)^2} = \sqrt{100} = 10$

(c) Midpoint: $\left(\frac{0+6}{2}, \frac{8+16}{2}\right) = (3, 12)$

26. (a)

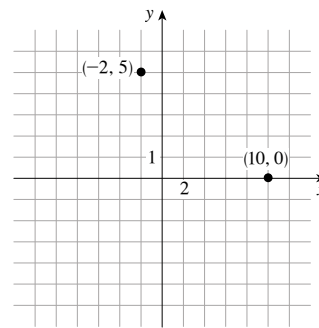

(b) $d = \sqrt{(-2-10)^2 + (5-0)^2}$
 $= \sqrt{(-12)^2 + (5)^2} = \sqrt{169} = 13$

(c) Midpoint: $\left(\frac{-2+10}{2}, \frac{5+0}{2}\right) = \left(4, \frac{5}{2}\right)$

27. (a)

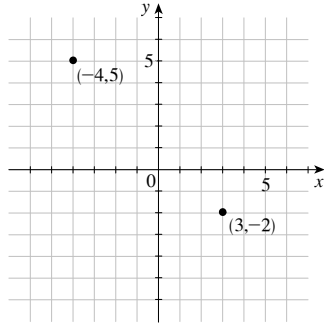

$$\begin{aligned} \text{(b) } d &= \sqrt{(3 - (-4))^2 + (-2 - 5)^2} \\ &= \sqrt{7^2 + (-7)^2} = \sqrt{49 + 49} = \sqrt{98} = 7\sqrt{2} \end{aligned}$$

$$\text{(c) Midpoint: } \left(\frac{-4 + 3}{2}, \frac{5 - 2}{2} \right) = \left(-\frac{1}{2}, \frac{3}{2} \right)$$

28. (a)

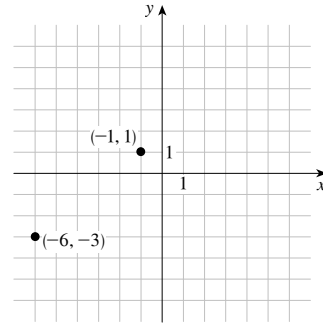

$$\begin{aligned} \text{(b) } d &= \sqrt{(-1 - (-6))^2 + (1 - (-3))^2} \\ &= \sqrt{5^2 + 4^2} = \sqrt{41} \end{aligned}$$

$$\text{(c) Midpoint: } \left(\frac{-6 - 1}{2}, \frac{-3 + 1}{2} \right) = \left(-\frac{7}{2}, -1 \right)$$

29. (a)

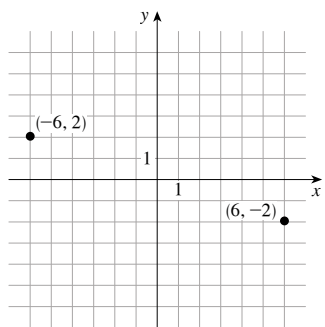

$$\begin{aligned} \text{(b) } d &= \sqrt{(6 - (-6))^2 + (-2 - 2)^2} = \sqrt{12^2 + (-4)^2} \\ &= \sqrt{144 + 16} = \sqrt{160} = 4\sqrt{10} \end{aligned}$$

$$\text{(c) Midpoint: } \left(\frac{6 - 6}{2}, \frac{-2 + 2}{2} \right) = (0, 0)$$

30. (a)

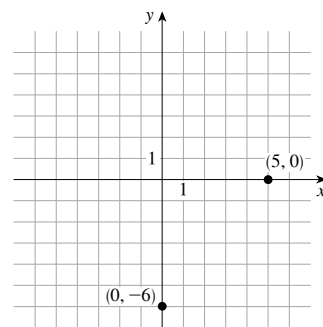

$$\begin{aligned} \text{(b) } d &= \sqrt{(0 - 5)^2 + (-6 - 0)^2} \\ &= \sqrt{5^2 + (-6)^2} = \sqrt{25 + 36} = \sqrt{61} \end{aligned}$$

$$\text{(c) Midpoint: } \left(\frac{0 + 5}{2}, \frac{-6 + 0}{2} \right) = \left(\frac{5}{2}, -3 \right)$$

$$31. d(A, B) = \sqrt{(1-5)^2 + (3-3)^2} = \sqrt{(-4)^2} = 4.$$

$$d(A, C) = \sqrt{(1-1)^2 + (3-(-3))^2} = \sqrt{(6)^2} = 6. \text{ So}$$

the area is $4 \cdot 6 = 24$.

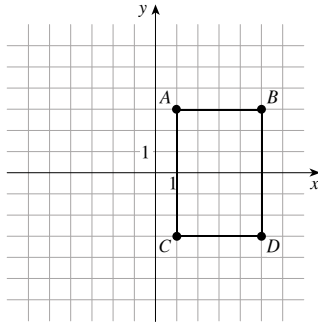

32. The area of a parallelogram is its base times its height.

Since two sides are parallel to the x -axis, we use the length of one of these as the base. Thus, the base is

$$d(A, B) = \sqrt{(1-5)^2 + (2-2)^2} = \sqrt{(-4)^2} = 4. \text{ The}$$

height is the change in the y coordinates, thus, the height is $6 - 2 = 4$. So the area of the parallelogram is

$$\text{base} \cdot \text{height} = 4 \cdot 4 = 16.$$

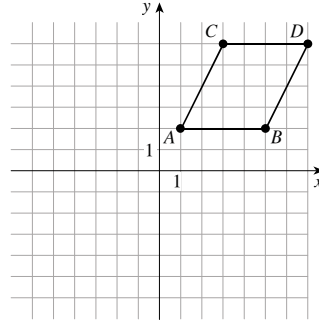

33. From the graph, the quadrilateral $ABCD$ has a pair of parallel sides, so $ABCD$ is a trapezoid. The area is

$$\left(\frac{b_1 + b_2}{2}\right)h. \text{ From the graph we see that}$$

$$b_1 = d(A, B) = \sqrt{(1-5)^2 + (0-0)^2} = \sqrt{4^2} = 4;$$

$$b_2 = d(C, D) = \sqrt{(4-2)^2 + (3-3)^2} = \sqrt{2^2} = 2; \text{ and}$$

h is the difference in y -coordinates is $|3 - 0| = 3$. Thus

$$\text{the area of the trapezoid is } \left(\frac{4+2}{2}\right)3 = 9.$$

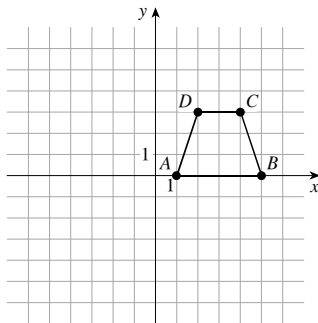

34. The point S must be located at $(0, -4)$. To find the area, we find the length of one side and square it. This gives

$$d(Q, R) = \sqrt{(-5-0)^2 + (1-6)^2}$$

$$= \sqrt{(-5)^2 + (-5)^2}$$

$$= \sqrt{25 + 25} = \sqrt{50}$$

So the area is $(\sqrt{50})^2 = 50$.

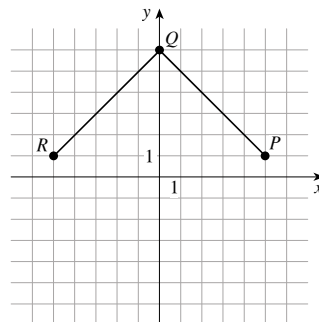

$$35. d(0, A) = \sqrt{(6-0)^2 + (7-0)^2} = \sqrt{6^2 + 7^2} = \sqrt{36 + 49} = \sqrt{85}.$$

$$d(0, B) = \sqrt{(-5-0)^2 + (8-0)^2} = \sqrt{(-5)^2 + 8^2} = \sqrt{25 + 64} = \sqrt{89}.$$

Thus point $A(6, 7)$ is closer to the origin.

$$36. d(E, C) = \sqrt{(-6 - (-2))^2 + (3 - 1)^2} = \sqrt{(-4)^2 + 2^2} = \sqrt{16 + 4} = \sqrt{20}.$$

$$d(E, D) = \sqrt{(3 - (-2))^2 + (0 - 1)^2} = \sqrt{5^2 + (-1)^2} = \sqrt{25 + 1} = \sqrt{26}.$$

Thus point C is closer to point E .

$$37. d(P, R) = \sqrt{(-1 - 3)^2 + (-1 - 1)^2} = \sqrt{(-4)^2 + (-2)^2} = \sqrt{16 + 4} = \sqrt{20} = 2\sqrt{5}.$$

$$d(Q, R) = \sqrt{(-1 - (-1))^2 + (-1 - 3)^2} = \sqrt{0 + (-4)^2} = \sqrt{16} = 4. \text{ Thus point } Q(-1, 3) \text{ is closer to point } R.$$

38. (a) The distance from $(7, 3)$ to the origin is $\sqrt{(7 - 0)^2 + (3 - 0)^2} = \sqrt{7^2 + 3^2} = \sqrt{49 + 9} = \sqrt{58}$. The distance from $(3, 7)$ to the origin is $\sqrt{(3 - 0)^2 + (7 - 0)^2} = \sqrt{3^2 + 7^2} = \sqrt{9 + 49} = \sqrt{58}$. So the points are the same distance from the origin.

(b) The distance from (a, b) to the origin is $\sqrt{(a - 0)^2 + (b - 0)^2} = \sqrt{a^2 + b^2}$. The distance from (b, a) to the origin is $\sqrt{(b - 0)^2 + (a - 0)^2} = \sqrt{b^2 + a^2} = \sqrt{a^2 + b^2}$. So the points are the same distance from the origin.

39. Since we do not know which pair are isosceles, we find the length of all three sides.

$$d(A, B) = \sqrt{(-3 - 0)^2 + (-1 - 2)^2} = \sqrt{(-3)^2 + (-3)^2} = \sqrt{9 + 9} = \sqrt{18} = 3\sqrt{2}.$$

$$d(C, B) = \sqrt{(-3 - (-4))^2 + (-1 - 3)^2} = \sqrt{1^2 + (-4)^2} = \sqrt{1 + 16} = \sqrt{17}.$$

$$d(A, C) = \sqrt{(0 - (-4))^2 + (2 - 3)^2} = \sqrt{4^2 + (-1)^2} = \sqrt{16 + 1} = \sqrt{17}. \text{ So sides } AC \text{ and } CB \text{ have the same length.}$$

40. Since the side AB is parallel to the x -axis, we use this as the base in the formula $\text{area} = \frac{1}{2}(\text{base} \cdot \text{height})$. The height is the change in the y -coordinates. Thus, the base is $|-2 - 4| = 6$ and the height is $|4 - 1| = 3$. So the area is $\frac{1}{2}(6 \cdot 3) = 9$.

41. (a) Here we have $A = (2, 2)$, $B = (3, -1)$, and $C = (-3, -3)$. So

$$d(A, B) = \sqrt{(3 - 2)^2 + (-1 - 2)^2} = \sqrt{1^2 + (-3)^2} = \sqrt{1 + 9} = \sqrt{10};$$

$$d(C, B) = \sqrt{(3 - (-3))^2 + (-1 - (-3))^2} = \sqrt{6^2 + 2^2} = \sqrt{36 + 4} = \sqrt{40} = 2\sqrt{10};$$

$$d(A, C) = \sqrt{(-3 - 2)^2 + (-3 - 2)^2} = \sqrt{(-5)^2 + (-5)^2} = \sqrt{25 + 25} = \sqrt{50} = 5\sqrt{2}.$$

Since $[d(A, B)]^2 + [d(C, B)]^2 = [d(A, C)]^2$, we conclude that the triangle is a right triangle.

(b) The area of the triangle is $\frac{1}{2} \cdot d(C, B) \cdot d(A, B) = \frac{1}{2} \cdot \sqrt{10} \cdot 2\sqrt{10} = 10$.

$$42. d(A, B) = \sqrt{(11 - 6)^2 + (-3 - (-7))^2} = \sqrt{5^2 + 4^2} = \sqrt{25 + 16} = \sqrt{41};$$

$$d(A, C) = \sqrt{(2 - 6)^2 + (-2 - (-7))^2} = \sqrt{(-4)^2 + 5^2} = \sqrt{16 + 25} = \sqrt{41};$$

$$d(B, C) = \sqrt{(2 - 11)^2 + (-2 - (-3))^2} = \sqrt{(-9)^2 + 1^2} = \sqrt{81 + 1} = \sqrt{82}.$$

Since $[d(A, B)]^2 + [d(A, C)]^2 = [d(B, C)]^2$, we conclude that the triangle is a right triangle. The area is

$$\frac{1}{2}(\sqrt{41} \cdot \sqrt{41}) = \frac{41}{2}.$$

43. We show that all sides are the same length (its a rhombus) and then show that the diagonals are equal. Here we have

$A = (-2, 9)$, $B = (4, 6)$, $C = (1, 0)$, and $D = (-5, 3)$. So

$$d(A, B) = \sqrt{(4 - (-2))^2 + (6 - 9)^2} = \sqrt{6^2 + (-3)^2} = \sqrt{36 + 9} = \sqrt{45};$$

$$d(B, C) = \sqrt{(1 - 4)^2 + (0 - 6)^2} = \sqrt{(-3)^2 + (-6)^2} = \sqrt{9 + 36} = \sqrt{45};$$

$$d(C, D) = \sqrt{(-5 - 1)^2 + (3 - 0)^2} = \sqrt{(-6)^2 + (-3)^2} = \sqrt{36 + 9} = \sqrt{45};$$

$$d(D, A) = \sqrt{(-2 - (-5))^2 + (9 - 3)^2} = \sqrt{3^2 + 6^2} = \sqrt{9 + 36} = \sqrt{45}. \text{ So the points form a}$$

rhombus. Also $d(A, C) = \sqrt{(1 - (-2))^2 + (0 - 9)^2} = \sqrt{3^2 + (-9)^2} = \sqrt{9 + 81} = \sqrt{90} = 3\sqrt{10}$,

and $d(B, D) = \sqrt{(-5 - 4)^2 + (3 - 6)^2} = \sqrt{(-9)^2 + (-3)^2} = \sqrt{81 + 9} = \sqrt{90} = 3\sqrt{10}$. Since the diagonals are equal, the rhombus is a square.

44. $d(A, B) = \sqrt{(3 - (-1))^2 + (11 - 3)^2} = \sqrt{4^2 + 8^2} = \sqrt{16 + 64} = \sqrt{80} = 4\sqrt{5}$.

$$d(B, C) = \sqrt{(5 - 3)^2 + (15 - 11)^2} = \sqrt{2^2 + 4^2} = \sqrt{4 + 16} = \sqrt{20} = 2\sqrt{5}.$$

$d(A, C) = \sqrt{(5 - (-1))^2 + (15 - 3)^2} = \sqrt{6^2 + 12^2} = \sqrt{36 + 144} = \sqrt{180} = 6\sqrt{5}$. So $d(A, B) + d(B, C) = d(A, C)$, and the points are collinear.

45. Let $P = (0, y)$ be such a point. Setting the distances equal we get

$$\sqrt{(0 - 5)^2 + (y - (-5))^2} = \sqrt{(0 - 1)^2 + (y - 1)^2} \Leftrightarrow$$

$\sqrt{25 + y^2 + 10y + 25} = \sqrt{1 + y^2 - 2y + 1} \Rightarrow y^2 + 10y + 50 = y^2 - 2y + 2 \Leftrightarrow 12y = -48 \Leftrightarrow y = -4$. Thus, the point is $P = (0, -4)$. Check:

$$\sqrt{(0 - 5)^2 + (-4 - (-5))^2} = \sqrt{(-5)^2 + 1^2} = \sqrt{25 + 1} = \sqrt{26};$$

$$\sqrt{(0 - 1)^2 + (-4 - 1)^2} = \sqrt{(-1)^2 + (-5)^2} = \sqrt{25 + 1} = \sqrt{26}.$$

46. The midpoint of AB is $C' = \left(\frac{1+3}{2}, \frac{0+6}{2}\right) = (2, 3)$. So the length of the median CC' is $d(C, C') =$

$\sqrt{(2 - 8)^2 + (3 - 2)^2} = \sqrt{37}$. The midpoint of AC is $B' = \left(\frac{1+8}{2}, \frac{0+2}{2}\right) = \left(\frac{9}{2}, 1\right)$. So the length of the median BB'

is $d(B, B') = \sqrt{\left(\frac{9}{2} - 3\right)^2 + (1 - 6)^2} = \frac{\sqrt{109}}{2}$. The midpoint of BC is $A' = \left(\frac{3+8}{2}, \frac{6+2}{2}\right) = \left(\frac{11}{2}, 4\right)$. So the length

of the median AA' is $d(A, A') = \sqrt{\left(\frac{11}{2} - 1\right)^2 + (4 - 0)^2} = \frac{\sqrt{145}}{2}$.

47. As indicated by Example 3, we must find a point $S(x_1, y_1)$ such that the midpoints of PR and of QS are the same. Thus

$\left(\frac{4 + (-1)}{2}, \frac{2 + (-4)}{2}\right) = \left(\frac{x_1 + 1}{2}, \frac{y_1 + 1}{2}\right)$. Setting the x -coordinates equal,

we get $\frac{4 + (-1)}{2} = \frac{x_1 + 1}{2} \Leftrightarrow 4 - 1 = x_1 + 1 \Leftrightarrow x_1 = 2$. Setting the

y -coordinates equal, we get $\frac{2 + (-4)}{2} = \frac{y_1 + 1}{2} \Leftrightarrow 2 - 4 = y_1 + 1 \Leftrightarrow y_1 = -3$.

Thus $S = (2, -3)$.

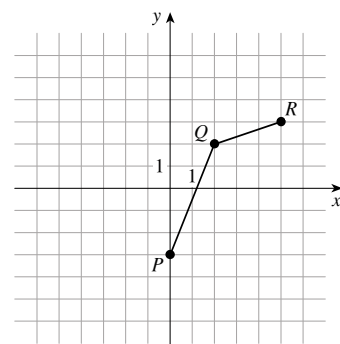

48. We solve the equation $6 = \frac{2+x}{2}$ to find the x coordinate of B . This gives $6 = \frac{2+x}{2} \Leftrightarrow 12 = 2+x \Leftrightarrow x = 10$. Likewise, $8 = \frac{3+y}{2} \Leftrightarrow 16 = 3+y \Leftrightarrow y = 13$. Thus, $B = (10, 13)$.

49. (a)

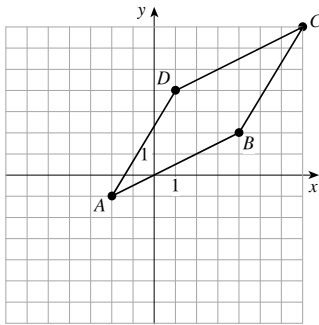

(b) The midpoint of AC is $\left(\frac{-2+7}{2}, \frac{-1+7}{2}\right) = \left(\frac{5}{2}, 3\right)$, the midpoint of BD is $\left(\frac{4+1}{2}, \frac{2+4}{2}\right) = \left(\frac{5}{2}, 3\right)$.

(c) Since they have the same midpoint, we conclude that the diagonals bisect each other.

50. We have $M = \left(\frac{a+0}{2}, \frac{b+0}{2}\right) = \left(\frac{a}{2}, \frac{b}{2}\right)$. Thus,

$$d(C, M) = \sqrt{\left(\frac{a}{2} - 0\right)^2 + \left(\frac{b}{2} - 0\right)^2} = \sqrt{\frac{a^2}{4} + \frac{b^2}{4}} = \frac{\sqrt{a^2 + b^2}}{2};$$

$$d(A, M) = \sqrt{\left(\frac{a}{2} - a\right)^2 + \left(\frac{b}{2} - 0\right)^2} = \sqrt{\left(-\frac{a}{2}\right)^2 + \left(\frac{b}{2}\right)^2} = \sqrt{\frac{a^2}{4} + \frac{b^2}{4}} = \frac{\sqrt{a^2 + b^2}}{2};$$

$$d(B, M) = \sqrt{\left(\frac{a}{2} - 0\right)^2 + \left(\frac{b}{2} - b\right)^2} = \sqrt{\left(\frac{a}{2}\right)^2 + \left(-\frac{b}{2}\right)^2} = \sqrt{\frac{a^2}{4} + \frac{b^2}{4}} = \frac{\sqrt{a^2 + b^2}}{2}.$$

51. (a) The point $(5, 3)$ is shifted to $(5 + 3, 3 + 2) = (8, 5)$.
 (b) The point (a, b) is shifted to $(a + 3, b + 2)$.
 (c) Let (x, y) be the point that is shifted to $(3, 4)$. Then $(x + 3, y + 2) = (3, 4)$. Setting the x -coordinates equal, we get $x + 3 = 3 \Leftrightarrow x = 0$. Setting the y -coordinates equal, we get $y + 2 = 4 \Leftrightarrow y = 2$. So the point is $(0, 2)$.
 (d) $A = (-5, -1)$, so $A' = (-5 + 3, -1 + 2) = (-2, 1)$; $B = (-3, 2)$, so $B' = (-3 + 3, 2 + 2) = (0, 4)$; and $C = (2, 1)$, so $C' = (2 + 3, 1 + 2) = (5, 3)$.
52. (a) The point $(3, 7)$ is reflected to the point $(-3, 7)$.
 (b) The point (a, b) is reflected to the point $(-a, b)$.
 (c) Since the point $(-a, b)$ is the reflection of (a, b) , the point $(-4, -1)$ is the reflection of $(4, -1)$.
 (d) $A = (3, 3)$, so $A' = (-3, 3)$; $B = (6, 1)$, so $B' = (-6, 1)$; and $C = (1, -4)$, so $C' = (-1, -4)$.
53. (a) $d(A, B) = \sqrt{3^2 + 4^2} = \sqrt{25} = 5$.
 (b) We want the distances from $C = (4, 2)$ to $D = (11, 26)$. The walking distance is $|4 - 11| + |2 - 26| = 7 + 24 = 31$ blocks. Straight-line distance is $\sqrt{(4 - 11)^2 + (2 - 26)^2} = \sqrt{7^2 + 24^2} = \sqrt{625} = 25$ blocks.
 (c) The two points are on the same avenue or the same street.
54. (a) The midpoint is at $\left(\frac{3+27}{2}, \frac{7+17}{2}\right) = (15, 12)$, which is at the intersection of 15th Street and 12th Avenue.
 (b) They each must walk $|15 - 3| + |12 - 7| = 12 + 5 = 17$ blocks.
55. The midpoint of the line segment is $(66, 45)$. The pressure experienced by an ocean diver at a depth of 66 feet is 45 lb/in^2 .

56. We solve the equation $6 = \frac{2+x}{2}$ to find the x coordinate of B : $6 = \frac{2+x}{2} \Leftrightarrow 12 = 2+x \Leftrightarrow x = 10$. Likewise, for the y coordinate of B , we have $8 = \frac{3+y}{2} \Leftrightarrow 16 = 3+y \Leftrightarrow y = 13$. Thus $B = (10, 13)$.

57. We need to find a point $S(x_1, y_1)$ such that $PQRS$ is a parallelogram. As indicated by Example 3, this will be the case if the diagonals PR and QS bisect each other. So the midpoints of PR and QS are the same. Thus

$\left(\frac{0+5}{2}, \frac{-3+3}{2}\right) = \left(\frac{x_1+2}{2}, \frac{y_1+2}{2}\right)$. Setting the x -coordinates equal, we get

$$\frac{0+5}{2} = \frac{x_1+2}{2} \Leftrightarrow 0+5 = x_1+2 \Leftrightarrow x_1 = 3.$$

Setting the y -coordinates equal, we get $\frac{-3+3}{2} = \frac{y_1+2}{2} \Leftrightarrow -3+3 = y_1+2 \Leftrightarrow y_1 = -2$. Thus $S = (3, -2)$.

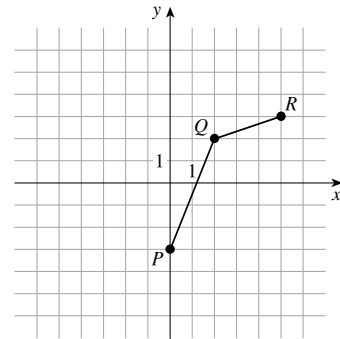

1.2 GRAPHS OF EQUATIONS IN TWO VARIABLES: CIRCLES

1. If the point $(2, 3)$ is on the graph of an equation in x and y , then the equation is satisfied when we replace x by 2 and y by 3. We check whether $2(3) \stackrel{?}{=} 2+1 \Leftrightarrow 6 \stackrel{?}{=} 3$. This is false, so the point $(2, 3)$ is not on the graph of the equation $2y = x + 1$. To complete the table, we express y in terms of x : $2y = x + 1 \Leftrightarrow y = \frac{1}{2}(x + 1) = \frac{1}{2}x + \frac{1}{2}$.

x	y	(x, y)
-2	$-\frac{1}{2}$	$\left(-2, -\frac{1}{2}\right)$
-1	0	$(-1, 0)$
0	$\frac{1}{2}$	$\left(0, \frac{1}{2}\right)$
1	1	$(1, 1)$
2	$\frac{3}{2}$	$\left(2, \frac{3}{2}\right)$

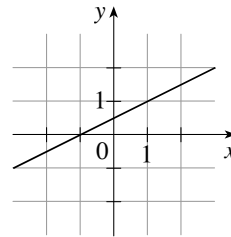

2. To find the x -intercept(s) of the graph of an equation we set y equal to 0 in the equation and solve for x : $2(0) = x + 1 \Leftrightarrow x = -1$, so the x -intercept of $2y = x + 1$ is -1 .
3. To find the y -intercept(s) of the graph of an equation we set x equal to 0 in the equation and solve for y : $2y = 0 + 1 \Leftrightarrow y = \frac{1}{2}$, so the y -intercept of $2y = x + 1$ is $\frac{1}{2}$.
4. The graph of the equation $(x - 1)^2 + (y - 2)^2 = 9$ is a circle with center $(1, 2)$ and radius $\sqrt{9} = 3$.
5. (a) If a graph is symmetric with respect to the x -axis and (a, b) is on the graph, then $(a, -b)$ is also on the graph.
 (b) If a graph is symmetric with respect to the y -axis and (a, b) is on the graph, then $(-a, b)$ is also on the graph.
 (c) If a graph is symmetric about the origin and (a, b) is on the graph, then $(-a, -b)$ is also on the graph.
6. (a) The x -intercepts are -3 and 3 and the y -intercepts are -1 and 2 .
 (b) The graph is symmetric about the y -axis.
7. Yes, this is true. If for every point (x, y) on the graph, $(-x, y)$ and $(x, -y)$ are also on the graph, then $(-x, -y)$ must be on the graph as well, and so it is symmetric about the origin.
8. No, this is not necessarily the case. For example, the graph of $y = x$ is symmetric about the origin, but not about either axis.

9. $y = 3 - 4x$. For the point $(0, 3)$: $3 \stackrel{?}{=} 3 - 4(0) \Leftrightarrow 3 = 3$. Yes. For $(4, 0)$: $0 \stackrel{?}{=} 3 - 4(4) \Leftrightarrow 0 \stackrel{?}{=} -13$. No. For $(1, -1)$: $-1 \stackrel{?}{=} 3 - 4(1) \Leftrightarrow -1 \stackrel{?}{=} -1$. Yes.

So the points $(0, 3)$ and $(1, -1)$ are on the graph of this equation.

10. $y = \sqrt{1-x}$. For the point $(2, 1)$: $1 \stackrel{?}{=} \sqrt{1-2} \Leftrightarrow 1 \stackrel{?}{=} \sqrt{-1}$. No. For $(-3, 2)$: $2 \stackrel{?}{=} \sqrt{1-(-3)} \Leftrightarrow 2 \stackrel{?}{=} \sqrt{4}$. Yes. For $(0, 1)$: $1 \stackrel{?}{=} \sqrt{1-0}$. Yes.

So the points $(-3, 2)$ and $(0, 1)$ are on the graph of this equation.

11. $x - 2y - 1 = 0$. For the point $(0, 0)$: $0 - 2(0) - 1 \stackrel{?}{=} 0 \Leftrightarrow -1 \stackrel{?}{=} 0$. No. For $(1, 0)$: $1 - 2(0) - 1 \stackrel{?}{=} 0 \Leftrightarrow -1 + 1 \stackrel{?}{=} 0$. Yes.

For $(-1, -1)$: $(-1) - 2(-1) - 1 \stackrel{?}{=} 0 \Leftrightarrow -1 + 2 - 1 \stackrel{?}{=} 0$. Yes.

So the points $(1, 0)$ and $(-1, -1)$ are on the graph of this equation.

12. $y(x^2 + 1) = 1$. For the point $(1, 1)$: $(1) \left[(1)^2 + 1 \right] \stackrel{?}{=} 1 \Leftrightarrow 1(2) \stackrel{?}{=} 1$. No. For $(1, \frac{1}{2})$: $(\frac{1}{2}) \left[(1)^2 + 1 \right] \stackrel{?}{=} 1 \Leftrightarrow \frac{1}{2}(2) \stackrel{?}{=} 1$.

Yes. For $(-1, \frac{1}{2})$: $(\frac{1}{2}) \left[(-1)^2 + 1 \right] \stackrel{?}{=} 1 \Leftrightarrow \frac{1}{2}(2) \stackrel{?}{=} 1$. Yes.

So the points $(1, \frac{1}{2})$ and $(-1, \frac{1}{2})$ are on the graph of this equation.

13. $x^2 + 2xy + y^2 = 1$. For the point $(0, 1)$: $0^2 + 2(0)(1) + 1^2 \stackrel{?}{=} 1 \Leftrightarrow 1 \stackrel{?}{=} 1$. Yes. For $(2, -1)$: $2^2 + 2(2)(-1) + (-1)^2 \stackrel{?}{=} 1 \Leftrightarrow 4 - 4 + 1 \stackrel{?}{=} 1 \Leftrightarrow 1 = 1$. Yes. For $(-2, 3)$: $(-2)^2 + 2(-2)(3) + 3^2 \stackrel{?}{=} 1 \Leftrightarrow 4 - 12 + 9 \stackrel{?}{=} 1 \Leftrightarrow 1 \stackrel{?}{=} 1$. Yes.

So the points $(0, 1)$, $(2, -1)$, and $(-2, 3)$ are on the graph of this equation.

14. $(0, 1)$: $(0)^2 + (1)^2 - 1 \stackrel{?}{=} 0 \Leftrightarrow 0 + 1 - 1 \stackrel{?}{=} 0$. Yes.

$(\frac{1}{\sqrt{2}}, \frac{1}{\sqrt{2}})$: $(\frac{1}{\sqrt{2}})^2 + (\frac{1}{\sqrt{2}})^2 - 1 \stackrel{?}{=} 0 \Leftrightarrow \frac{1}{2} + \frac{1}{2} - 1 \stackrel{?}{=} 0$. Yes.

$(\frac{\sqrt{3}}{2}, \frac{1}{2})$: $(\frac{\sqrt{3}}{2})^2 + (\frac{1}{2})^2 - 1 \stackrel{?}{=} 0 \Leftrightarrow \frac{3}{4} + \frac{1}{4} - 1 \stackrel{?}{=} 0$. Yes.

So the points $(0, 1)$, $(\frac{1}{\sqrt{2}}, \frac{1}{\sqrt{2}})$, and $(\frac{\sqrt{3}}{2}, \frac{1}{2})$ are on the graph of this equation.

15. $y = 3x$

x	y
-3	-9
-2	-6
-1	-3
0	0
1	3
2	6
3	9

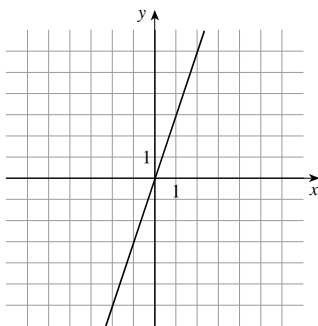

16. $y = -2x$

x	y
-3	6
-2	4
-1	2
0	0
1	-2
2	-4
3	-6

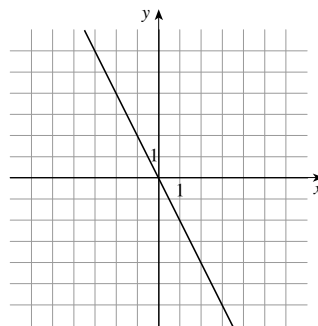

17. $y = 2 - x$

x	y
-4	6
-2	4
0	2
2	0
4	-2

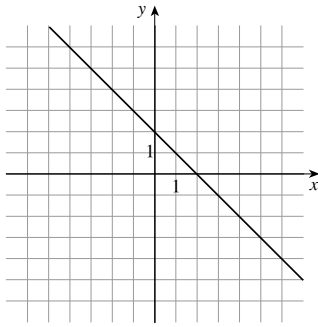

18. $y = 2x + 3$

x	y
-4	-5
-2	-1
0	3
2	7
4	11

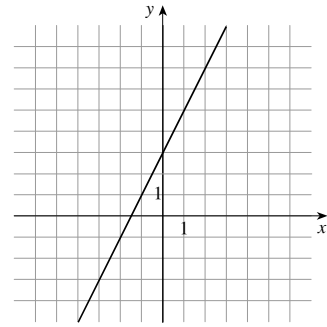

19. Solve for y: $2x - y = 6 \Leftrightarrow y = 2x - 6$.

x	y
-2	-10
0	-6
2	-2
4	2
6	6

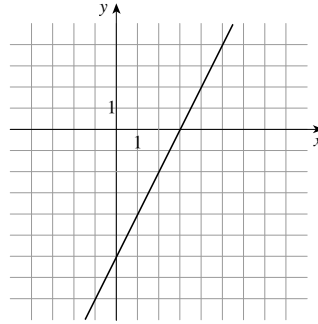

20. Solve for x: $x - 4y = 8 \Leftrightarrow x = 4y + 8$.

x	y
-4	-3
-2	$-\frac{5}{2}$
0	-2
2	$-\frac{3}{2}$
4	-1
6	$-\frac{1}{2}$
8	0
10	$\frac{1}{2}$

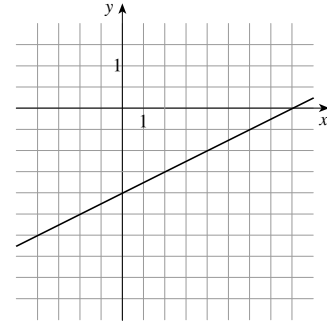

21. $y = 1 - x^2$

x	y
-3	-8
-2	-3
-1	0
0	1
1	0
2	-3
3	-8

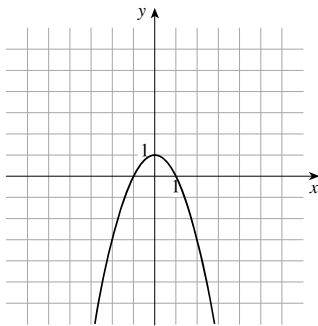

22. $y = x^2 + 2$

x	y
-3	11
-2	6
-1	3
0	2
1	3
2	6
3	11

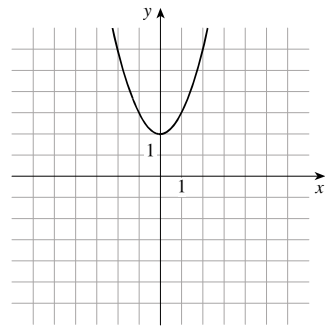

23. $y = x^2 - 2$

x	y
-3	7
-2	2
-1	-1
0	-2
1	-1
2	2
3	7

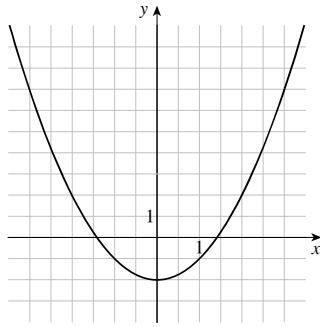

24. $y = -x^2 + 4$

x	y
-3	-5
-2	0
-1	3
0	4
1	3
2	0
3	-5

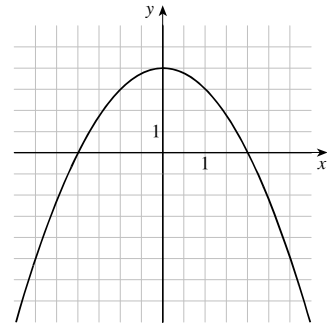

25. $9y = x^2$. To make a table, we rewrite the equation as

$y = \frac{1}{9}x^2$.

x	y
-9	9
-3	1
0	0
3	1
9	9

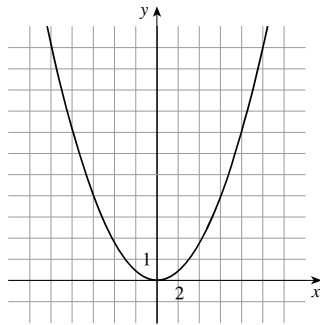

26. $4y = -x^2$.

x	y
-4	-4
-2	-1
0	0
2	-1
4	-4

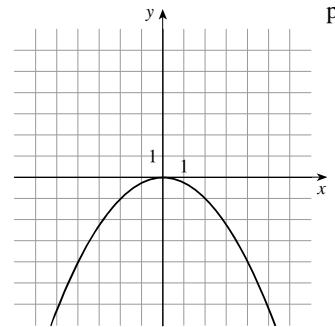

27. $x + y^2 = 4$.

x	y
-12	-4
-5	-3
0	-2
3	-1
4	0
3	1
0	2
-5	3
-12	4

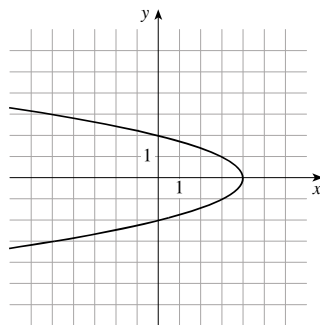

28. $xy = 2 \Leftrightarrow y = \frac{2}{x}$.

x	y
-4	$-\frac{1}{2}$
-2	-1
-1	-2
$-\frac{1}{2}$	-4
$-\frac{1}{4}$	-8
$\frac{1}{4}$	8
$\frac{1}{2}$	4
1	2
2	1
4	$\frac{1}{2}$

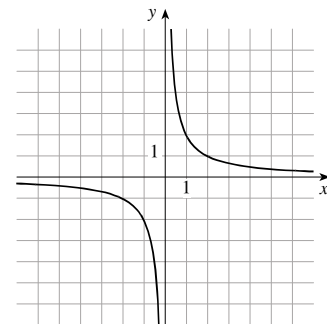

29. $y = \sqrt{x}$.

x	y
0	0
$\frac{1}{4}$	$\frac{1}{2}$
1	1
2	$\sqrt{2}$
4	2
9	3
16	4

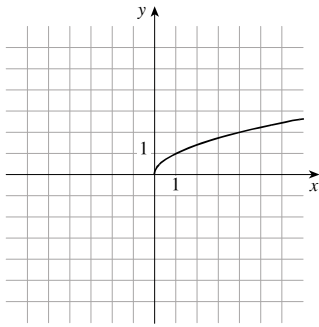

30. $y = 2 + \sqrt{x}$.

x	y
0	2
1	3
2	$2 + \sqrt{2}$
4	4
9	5

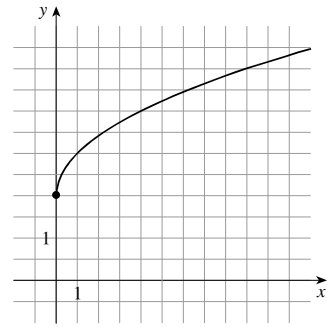

31. $y = -\sqrt{9-x^2}$. Since the radicand (the expression inside the square root) cannot be negative, we must have $9 - x^2 \geq 0 \Leftrightarrow x^2 \leq 9 \Leftrightarrow |x| \leq 3$.

x	y
-3	0
-2	$-\sqrt{5}$
-1	$-2\sqrt{2}$
0	-3
1	$-2\sqrt{2}$
2	$-\sqrt{5}$
3	0

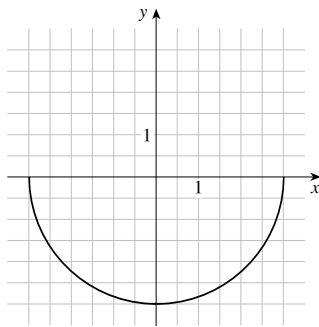

32. $y = \sqrt{9-x^2}$. Since the radicand (the expression inside the square root) cannot be negative, we must have $9 - x^2 \geq 0 \Leftrightarrow x^2 \leq 9 \Leftrightarrow |x| \leq 3$.

x	y
-3	0
-2	$\sqrt{5}$
-1	$2\sqrt{2}$
0	3
1	$2\sqrt{2}$
2	$\sqrt{5}$
3	0

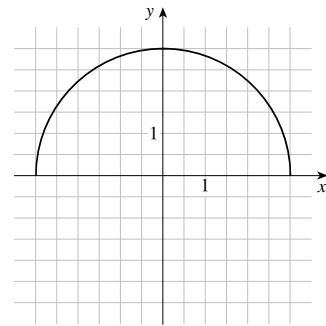

33. $y = -|x|$.

x	y
-6	-6
-4	-4
-2	-2
0	0
2	-2
4	-4
6	-6

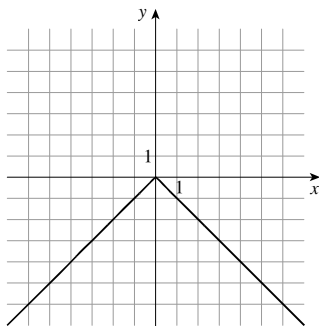

34. $x = |y|$. In the table below, we insert values of y and find the corresponding value of x.

x	y
3	-3
2	-2
1	-1
0	0
1	1
2	2
3	3

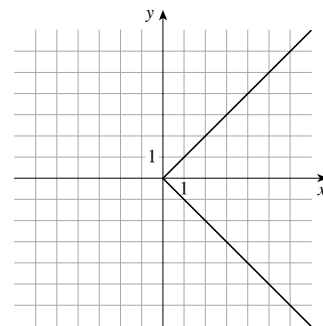

35. $y = 4 - |x|$.

x	y
-6	-2
-4	0
-2	2
0	4
2	2
4	0
6	-2

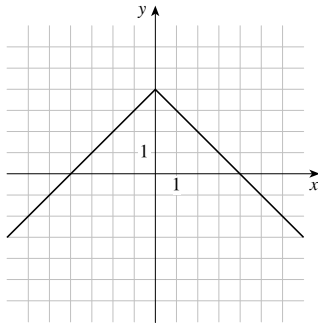

36. $y = |4 - x|$.

x	y
-6	10
-4	8
-2	6
0	4
2	2
4	0
6	2
8	4
10	6

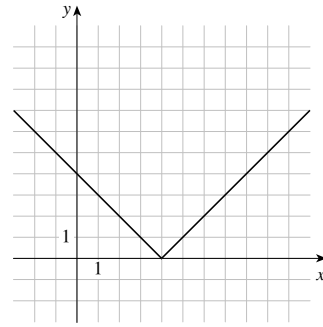

37. $x = y^3$. Since $x = y^3$ is solved for x in terms of y , we insert values for y and find the corresponding values of x in the table below.

x	y
-27	-3
-8	-2
-1	-1
0	0
1	1
8	2
27	3

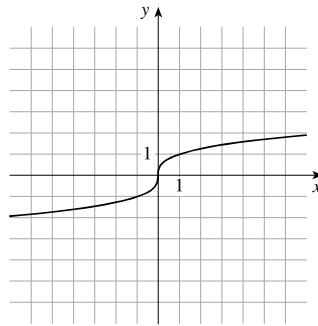

38. $y = x^3 - 1$.

x	y
-3	-28
-2	-9
-1	-2
0	-1
1	1
2	7
3	26

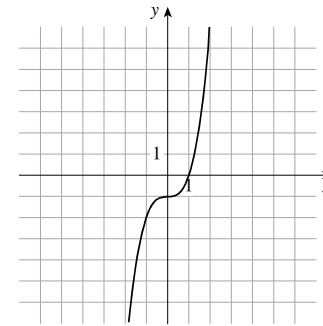

39. $y = x^4$.

x	y
-3	81
-2	16
-1	1
0	0
1	1
2	16
3	81

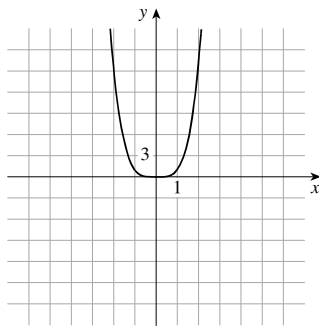

40. $y = 16 - x^4$.

x	y
-3	-65
-2	0
-1	15
0	16
1	15
2	0
3	-65

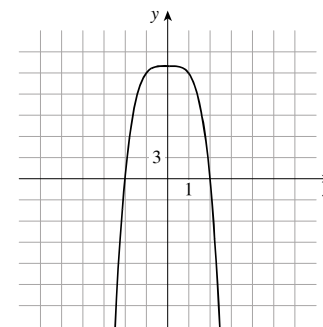

41. $y = 0.01x^3 - x^2 + 5$; $[-100, 150]$ by $[-2000, 2000]$

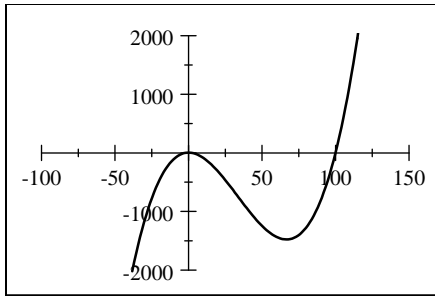

42. $y = 0.03x^2 + 1.7x - 3$; $[-100, 50]$ by $[-50, 100]$

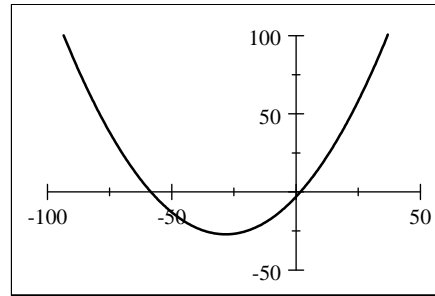

43. $y = \sqrt{12x - 17}$; $[-1, 10]$ by $[-1, 20]$

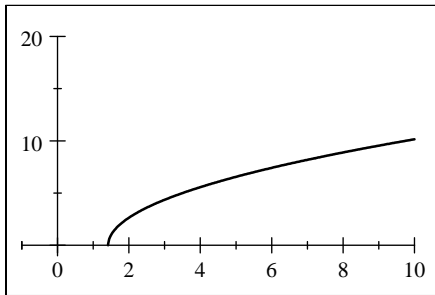

44. $y = \sqrt[4]{256 - x^2}$; $[-20, 20]$ by $[-2, 6]$

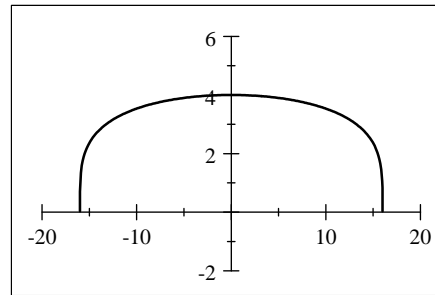

45. $y = \frac{x}{x^2 + 25}$; $[-50, 50]$ by $[-0.2, 0.2]$

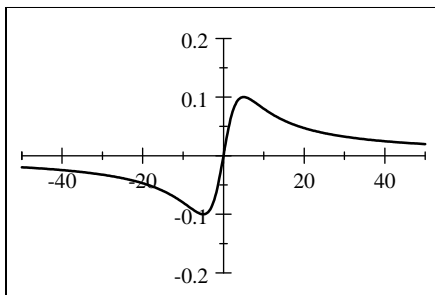

46. $y = x^4 - 4x^3$; $[-4, 6]$ by $[-50, 100]$

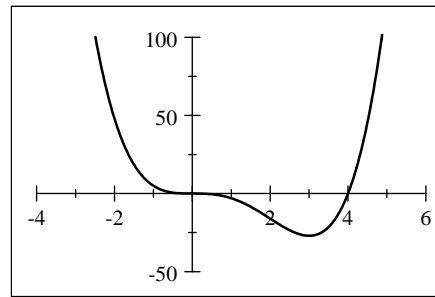

47. $y = x + 6$. To find x -intercepts, set $y = 0$. This gives $0 = x + 6 \Leftrightarrow x = -6$, so the x -intercept is -6 .

To find y -intercepts, set $x = 0$. This gives $y = 0 + 6 \Leftrightarrow y = 6$, so the y -intercept is 6 .

48. $2x - 5y = 40$. To find x -intercepts, set $y = 0$. This gives $2x - 5(0) = 40 \Leftrightarrow 2x = 40 \Leftrightarrow x = 20$, and the x -intercept is 20 .

To find y -intercepts, set $x = 0$. This gives $2(0) - 5y = 40 \Leftrightarrow y = -8$, so the y -intercept is -8 .

49. $y = x^2 - 5$. To find x -intercepts, set $y = 0$. This gives $0 = x^2 - 5 \Leftrightarrow x^2 = 5 \Rightarrow x = \pm\sqrt{5}$, so the x -intercepts are $\pm\sqrt{5}$.

To find y -intercepts, set $x = 0$. This gives $y = 0^2 - 5 = -5$, so the y -intercept is -5 .

50. $y^2 = 9 - x^2$. To find x -intercepts, set $y = 0$. This gives $0^2 = 9 - x^2 \Leftrightarrow x^2 = 9 \Rightarrow x = \pm 3$, so the x -intercepts are ± 3 .

To find y -intercepts, set $x = 0$. This gives $y^2 = 9 - 0^2 = 9 \Leftrightarrow y = \pm 3$, so the y -intercepts are ± 3 .

51. $y - 2xy + 2x = 1$. To find x -intercepts, set $y = 0$. This gives $0 - 2x(0) + 2x = 1 \Leftrightarrow 2x = 1 \Leftrightarrow x = \frac{1}{2}$, so the x -intercept is $\frac{1}{2}$.

To find y -intercepts, set $x = 0$. This gives $y - 2(0)y + 2(0) = 1 \Leftrightarrow y = 1$, so the y -intercept is 1 .

52. $x^2 - xy + y = 1$. To find x -intercepts, set $y = 0$. This gives $x^2 - x(0) + (0) = 1 \Leftrightarrow x^2 = 1 \Rightarrow x = \pm 1$, so the x -intercepts are -1 and 1 .

To find y -intercepts, set $x = 0$. This gives $y = (0)^2 - (0)y + y = 1 \Leftrightarrow y = 1$, so the y -intercept is 1 .

53. $y = \sqrt{x+1}$. To find x -intercepts, set $y = 0$. This gives $0 = \sqrt{x+1} \Leftrightarrow 0 = x+1 \Leftrightarrow x = -1$, so the x -intercept is -1 .

To find y -intercepts, set $x = 0$. This gives $y = \sqrt{0+1} \Leftrightarrow y = 1$, so the y -intercept is 1 .

54. $xy = 5$. To find x -intercepts, set $y = 0$. This gives $x(0) = 5 \Leftrightarrow 0 = 5$, which is impossible, so there is no x -intercept.

To find y -intercepts, set $x = 0$. This gives $(0)y = 5 \Leftrightarrow 0 = 5$, which is again impossible, so there is no y -intercept.

55. $4x^2 + 25y^2 = 100$. To find x -intercepts, set $y = 0$. This gives $4x^2 + 25(0)^2 = 100 \Leftrightarrow x^2 = 25 \Leftrightarrow x = \pm 5$, so the x -intercepts are -5 and 5 .

To find y -intercepts, set $x = 0$. This gives $4(0)^2 + 25y^2 = 100 \Leftrightarrow y^2 = 4 \Leftrightarrow y = \pm 2$, so the y -intercepts are -2 and 2 .

56. $25x^2 - y^2 = 100$. To find x -intercepts, set $y = 0$. This gives $25x^2 - 0^2 = 100 \Leftrightarrow x^2 = 4 \Leftrightarrow x = \pm 2$, so the x -intercepts are -2 and 2 .

To find y -intercepts, set $x = 0$. This gives $25(0)^2 - y^2 = 100 \Leftrightarrow y^2 = -100$, which has no solution, so there is no y -intercept.

57. $y = 4x - x^2$. To find x -intercepts, set $y = 0$. This gives $0 = 4x - x^2 \Leftrightarrow 0 = x(4 - x) \Leftrightarrow 0 = x$ or $x = 4$, so the x -intercepts are 0 and 4 .

To find y -intercepts, set $x = 0$. This gives $y = 4(0) - 0^2 \Leftrightarrow y = 0$, so the y -intercept is 0 .

58. $\frac{x^2}{9} + \frac{y^2}{4} = 1$. To find x -intercepts, set $y = 0$. This gives $\frac{x^2}{9} + \frac{0^2}{4} = 1 \Leftrightarrow \frac{x^2}{9} = 1 \Leftrightarrow x^2 = 9 \Leftrightarrow x = \pm 3$, so the x -intercepts are -3 and 3 .

To find y -intercepts, set $x = 0$. This gives $\frac{0^2}{9} + \frac{y^2}{4} = 1 \Leftrightarrow \frac{y^2}{4} = 1 \Leftrightarrow y^2 = 4 \Leftrightarrow y = \pm 2$, so the y -intercepts are -2 and 2 .

59. $x^4 + y^2 - xy = 16$. To find x -intercepts, set $y = 0$. This gives $x^4 + 0^2 - x(0) = 16 \Leftrightarrow x^4 = 16 \Leftrightarrow x = \pm 2$. So the x -intercepts are -2 and 2 .

To find y -intercepts, set $x = 0$. This gives $0^4 + y^2 - (0)y = 16 \Leftrightarrow y^2 = 16 \Leftrightarrow y = \pm 4$. So the y -intercepts are -4 and 4 .

60. $x^2 + y^3 - x^2y^2 = 64$. To find x -intercepts, set $y = 0$. This gives $x^2 + 0^3 - x^2(0)^2 = 64 \Leftrightarrow x^2 = 64 \Leftrightarrow x = \pm 8$. So the x -intercepts are -8 and 8 .

To find y -intercepts, set $x = 0$. This gives $0^2 + y^3 - (0)^2y^2 = 64 \Leftrightarrow y^3 = 64 \Leftrightarrow y = 4$. So the y -intercept is 4 .

61. (a) $y = x^3 - x^2$; $[-2, 2]$ by $[-1, 1]$

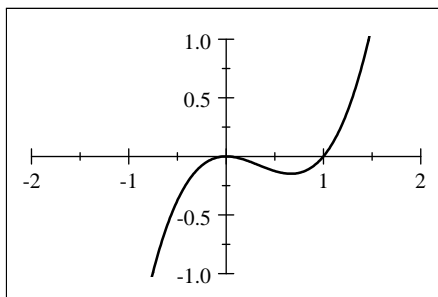

(b) From the graph, it appears that the x -intercepts are 0 and 1 and the y -intercept is 0 .

(c) To find x -intercepts, set $y = 0$. This gives

$$0 = x^3 - x^2 \Leftrightarrow x^2(x - 1) = 0 \Leftrightarrow x = 0 \text{ or } 1. \text{ So the } x\text{-intercepts are } 0 \text{ and } 1.$$

To find y -intercepts, set $x = 0$. This gives

$$y = 0^3 - 0^2 = 0. \text{ So the } y\text{-intercept is } 0.$$

62. (a) $y = x^4 - 2x^3$; $[-2, 3]$ by $[-3, 3]$

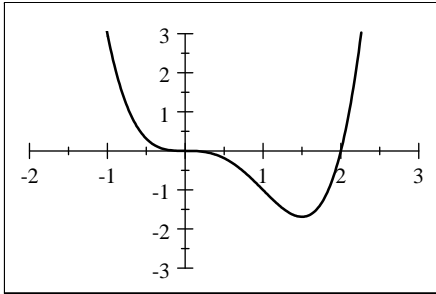

(b) From the graph, it appears that the x -intercepts are 0 and 2 and the y -intercept is 0.

(c) To find x -intercepts, set $y = 0$. This gives
 $0 = x^4 - 2x^3 \Leftrightarrow x^3(x - 2) = 0 \Leftrightarrow x = 0$ or 2 . So the x -intercepts are 0 and 2.

To find y -intercepts, set $x = 0$. This gives
 $y = 0^4 - 2(0)^3 = 0$. So the y -intercept is 0.

63. (a) $y = -\frac{2}{x^2 + 1}$; $[-5, 5]$ by $[-3, 1]$

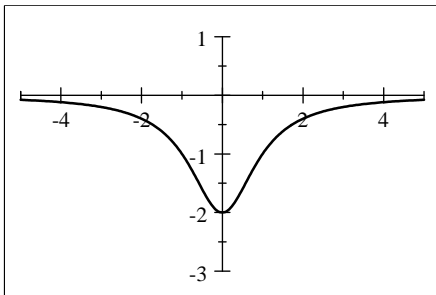

(b) From the graph, it appears that there is no x -intercept and the y -intercept is -2 .

(c) To find x -intercepts, set $y = 0$. This gives
 $0 = -\frac{2}{x^2 + 1}$, which has no solution. So there is no x -intercept.

To find y -intercepts, set $x = 0$. This gives
 $y = -\frac{2}{0^2 + 1} = -2$. So the y -intercept is -2 .

64. (a) $y = \frac{x}{x^2 + 1}$; $[-5, 5]$ by $[-2, 2]$

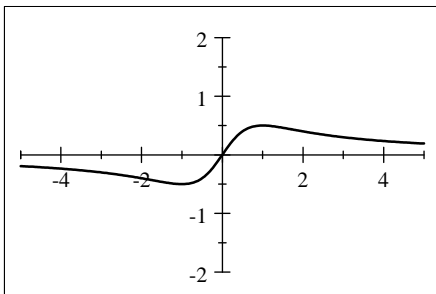

(b) From the graph, it appears that the x - and y -intercepts are 0.

(c) To find x -intercepts, set $y = 0$. This gives
 $0 = \frac{x}{x^2 + 1} \Leftrightarrow x = 0$. So the x -intercept is 0.

To find y -intercepts, set $x = 0$. This gives
 $y = \frac{0}{0^2 + 1} = 0$. So the y -intercept is 0.

65. (a) $y = \sqrt[3]{x}$; $[-5, 5]$ by $[-2, 2]$

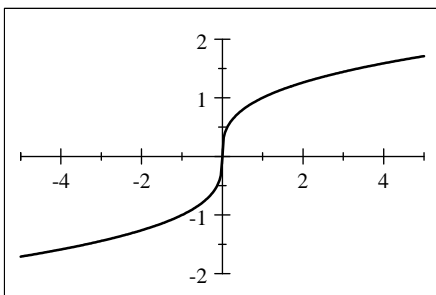

(b) From the graph, it appears that the x - and y -intercepts are 0.

(c) To find x -intercepts, set $y = 0$. This gives $0 = \sqrt[3]{x} \Leftrightarrow x = 0$. So the x -intercept is 0.

To find y -intercepts, set $x = 0$. This gives
 $y = \sqrt[3]{0} = 0$. So the y -intercept is 0.

66. (a) $y = \sqrt[3]{1-x^2}$; $[-5, 5]$ by $[-5, 3]$

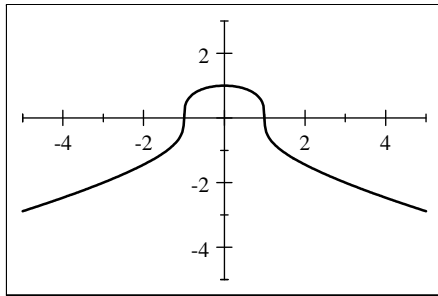

(b) From the graph, it appears that the x -intercepts are -1 and 1 and the y -intercept is 1 .

(c) To find x -intercepts, set $y = 0$. This gives $0 = \sqrt[3]{1-x^2} \Leftrightarrow 1-x^2 = 0 \Leftrightarrow x = \pm 1$. So the x -intercepts are -1 and 1 .

To find y -intercepts, set $x = 0$. This gives $y = \sqrt[3]{1-0^2} = 1$. So the y -intercept is 1 .

67. $x^2 + y^2 = 9$ has center $(0, 0)$ and radius 3 .

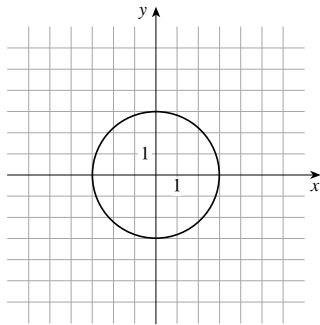

68. $x^2 + y^2 = 5$ has center $(0, 0)$ and radius $\sqrt{5}$.

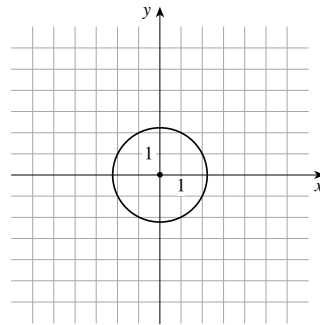

69. $(x-3)^2 + y^2 = 16$ has center $(3, 0)$ and radius 4 .

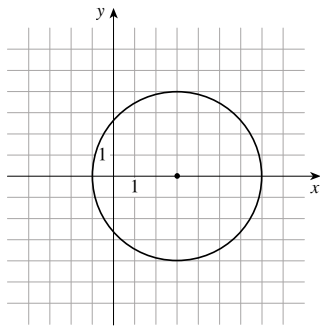

70. $x^2 + (y-2)^2 = 4$ has center $(0, 2)$ and radius 2 .

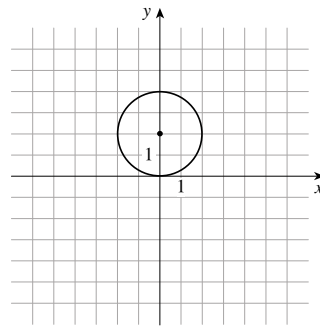

71. $(x+3)^2 + (y-4)^2 = 25$ has center $(-3, 4)$ and radius 5 . 72. $(x+1)^2 + (y+2)^2 = 36$ has center $(-1, -2)$ and radius 6 .

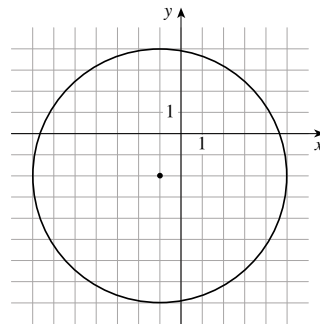
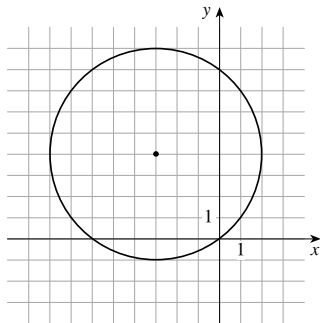

73. Using $h = -3, k = 2$, and $r = 5$, we get $(x - (-3))^2 + (y - 2)^2 = 5^2 \Leftrightarrow (x + 3)^2 + (y - 2)^2 = 25$.
74. Using $h = -1, k = -3$, and $r = 3$, we get $(x - (-1))^2 + (y - (-3))^2 = 3^2 \Leftrightarrow (x + 1)^2 + (y + 3)^2 = 9$.
75. The equation of a circle centered at the origin is $x^2 + y^2 = r^2$. Using the point $(4, 7)$ we solve for r^2 . This gives $(4)^2 + (7)^2 = r^2 \Leftrightarrow 16 + 49 = 65 = r^2$. Thus, the equation of the circle is $x^2 + y^2 = 65$.
76. Using $h = -1$ and $k = 5$, we get $(x - (-1))^2 + (y - 5)^2 = r^2 \Leftrightarrow (x + 1)^2 + (y - 5)^2 = r^2$. Next, using the point $(-4, -6)$, we solve for r^2 . This gives $(-4 + 1)^2 + (-6 - 5)^2 = r^2 \Leftrightarrow 130 = r^2$. Thus, an equation of the circle is $(x + 1)^2 + (y - 5)^2 = 130$.
77. The center is at the midpoint of the line segment, which is $\left(\frac{-1+5}{2}, \frac{1+9}{2}\right) = (2, 5)$. The radius is one half the diameter, so $r = \frac{1}{2}\sqrt{(-1-5)^2 + (1-9)^2} = \frac{1}{2}\sqrt{36+64} = \frac{1}{2}\sqrt{100} = 5$. Thus, an equation of the circle is $(x - 2)^2 + (y - 5)^2 = 5^2 \Leftrightarrow (x - 2)^2 + (y - 5)^2 = 25$.
78. The center is at the midpoint of the line segment, which is $\left(\frac{-1+7}{2}, \frac{3+(-5)}{2}\right) = (3, -1)$. The radius is one half the diameter, so $r = \frac{1}{2}\sqrt{(-1-7)^2 + (3-(-5))^2} = 4\sqrt{2}$. Thus, an equation of the circle is $(x - 3)^2 + (y + 1)^2 = 32$.
79. Since the circle is tangent to the x -axis, it must contain the point $(7, 0)$, so the radius is the change in the y -coordinates. That is, $r = |-3 - 0| = 3$. So the equation of the circle is $(x - 7)^2 + (y - (-3))^2 = 3^2$, which is $(x - 7)^2 + (y + 3)^2 = 9$.
80. Since the circle with $r = 5$ lies in the first quadrant and is tangent to both the x -axis and the y -axis, the center of the circle is at $(5, 5)$. Therefore, the equation of the circle is $(x - 5)^2 + (y - 5)^2 = 25$.
81. From the figure, the center of the circle is at $(-2, 2)$. The radius is the change in the y -coordinates, so $r = |2 - 0| = 2$. Thus the equation of the circle is $(x - (-2))^2 + (y - 2)^2 = 2^2$, which is $(x + 2)^2 + (y - 2)^2 = 4$.
82. From the figure, the center of the circle is at $(-1, 1)$. The radius is the distance from the center to the point $(2, 0)$. Thus $r = \sqrt{(-1-2)^2 + (1-0)^2} = \sqrt{9+1} = \sqrt{10}$, and the equation of the circle is $(x + 1)^2 + (y - 1)^2 = 10$.
83. Completing the square gives $x^2 + y^2 - 2x + 4y + 1 = 0 \Leftrightarrow x^2 - 2x + \left(\frac{-2}{2}\right)^2 + y^2 + 4y + \left(\frac{4}{2}\right)^2 = -1 + \left(\frac{-2}{2}\right)^2 + \left(\frac{4}{2}\right)^2 \Leftrightarrow x^2 - 2x + 1 + y^2 + 4y + 4 = -1 + 1 + 4 \Leftrightarrow (x - 1)^2 + (y + 2)^2 = 4$. Thus, the center is $(1, -2)$, and the radius is 2.
84. Completing the square gives $x^2 + y^2 - 2x - 2y = 2 \Leftrightarrow x^2 - 2x + \left(\frac{-2}{2}\right)^2 + y^2 - 2y + \left(\frac{-2}{2}\right)^2 = 2 + \left(\frac{-2}{2}\right)^2 + \left(\frac{-2}{2}\right)^2 \Leftrightarrow x^2 - 2x + 1 + y^2 - 2y + 1 = 2 + 1 + 1 \Leftrightarrow (x - 1)^2 + (y - 1)^2 = 4$. Thus, the center is $(1, 1)$, and the radius is 2.
85. Completing the square gives $x^2 + y^2 - 4x + 10y + 13 = 0 \Leftrightarrow x^2 - 4x + \left(\frac{-4}{2}\right)^2 + y^2 + 10y + \left(\frac{10}{2}\right)^2 = -13 + \left(\frac{4}{2}\right)^2 + \left(\frac{10}{2}\right)^2 \Leftrightarrow x^2 - 4x + 4 + y^2 + 10y + 25 = -13 + 4 + 25 \Leftrightarrow (x - 2)^2 + (y + 5)^2 = 16$. Thus, the center is $(2, -5)$, and the radius is 4.
86. Completing the square gives $x^2 + y^2 + 6y + 2 = 0 \Leftrightarrow x^2 + y^2 + 6y + \left(\frac{6}{2}\right)^2 = -2 + \left(\frac{6}{2}\right)^2 \Leftrightarrow x^2 + y^2 + 6y + 9 = -2 + 9 \Leftrightarrow x^2 + (y + 3)^2 = 7$. Thus, the circle has center $(0, -3)$ and radius $\sqrt{7}$.
87. Completing the square gives $x^2 + y^2 + x = 0 \Leftrightarrow x^2 + x + \left(\frac{1}{2}\right)^2 + y^2 = \left(\frac{1}{2}\right)^2 \Leftrightarrow x^2 + x + \frac{1}{4} + y^2 = \frac{1}{4} \Leftrightarrow \left(x + \frac{1}{2}\right)^2 + y^2 = \frac{1}{4}$. Thus, the circle has center $\left(-\frac{1}{2}, 0\right)$ and radius $\frac{1}{2}$.
88. Completing the square gives $x^2 + y^2 + 2x + y + 1 = 0 \Leftrightarrow x^2 + 2x + \left(\frac{2}{2}\right)^2 + y^2 + y + \left(\frac{1}{2}\right)^2 = -1 + 1 + \left(\frac{1}{2}\right)^2 \Leftrightarrow x^2 + 2x + 1 + y^2 + y + \frac{1}{4} = \frac{1}{4} \Leftrightarrow (x + 1)^2 + \left(y + \frac{1}{2}\right)^2 = \frac{1}{4}$. Thus, the circle has center $\left(-1, -\frac{1}{2}\right)$ and radius $\frac{1}{2}$.

89. Completing the square gives $x^2 + y^2 - \frac{1}{2}x + \frac{1}{2}y = \frac{1}{8} \Leftrightarrow x^2 - \frac{1}{2}x + \left(\frac{-1/2}{2}\right)^2 + y^2 + \frac{1}{2}y + \left(\frac{1/2}{2}\right)^2 = \frac{1}{8} + \left(\frac{-1/2}{2}\right)^2 + \left(\frac{1/2}{2}\right)^2$
 $\Leftrightarrow x^2 - \frac{1}{2}x + \frac{1}{16} + y^2 + \frac{1}{2}y + \frac{1}{16} = \frac{1}{8} + \frac{1}{16} + \frac{1}{16} = \frac{2}{8} = \frac{1}{4} \Leftrightarrow \left(x - \frac{1}{4}\right)^2 + \left(y + \frac{1}{4}\right)^2 = \frac{1}{4}$. Thus, the circle has center $\left(\frac{1}{4}, -\frac{1}{4}\right)$ and radius $\frac{1}{2}$.

90. Completing the square gives $x^2 + y^2 + \frac{1}{2}x + 2y + \frac{1}{16} = 0 \Leftrightarrow x^2 + \frac{1}{2}x + \left(\frac{1/2}{2}\right)^2 + y^2 + 2y + \left(\frac{2}{2}\right)^2 = -\frac{1}{16} + \left(\frac{1/2}{2}\right)^2 + \left(\frac{2}{2}\right)^2$
 $\Leftrightarrow \left(x + \frac{1}{4}\right)^2 + (y + 1)^2 = 1$. Thus, the circle has center $\left(-\frac{1}{4}, -1\right)$ and radius 1.

91. Completing the square gives $x^2 + y^2 + 4x - 10y = 21 \Leftrightarrow x^2 + 4x + \left(\frac{4}{2}\right)^2 + y^2 - 10y + \left(\frac{-10}{2}\right)^2 = 21 + \left(\frac{4}{2}\right)^2 + \left(\frac{-10}{2}\right)^2$
 $\Leftrightarrow (x + 2)^2 + (y - 5)^2 = 21 + 4 + 25 = 50$. Thus, the circle has center $(-2, 5)$ and radius $\sqrt{50} = 5\sqrt{2}$.

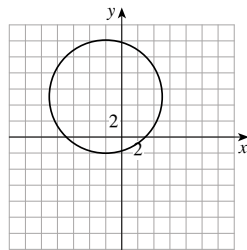

92. First divide by 4, then complete the square. This gives $4x^2 + 4y^2 + 2x = 0 \Leftrightarrow x^2 + y^2 + \frac{1}{2}x = 0 \Leftrightarrow x^2 + \frac{1}{2}x + \frac{1}{4} + y^2 = \frac{1}{4}$
 $\Leftrightarrow \left(x + \frac{1}{4}\right)^2 + y^2 = \frac{1}{16}$. Thus, the circle has center $\left(-\frac{1}{4}, 0\right)$ and radius $\frac{1}{4}$.

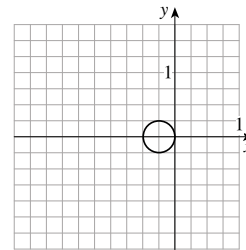

93. Completing the square gives $x^2 + y^2 + 6x - 12y + 45 = 0 \Leftrightarrow (x + 3)^2 + (y - 6)^2 = -45 + 9 + 36 = 0$. Thus, the center is $(-3, 6)$, and the radius is 0. This is a degenerate circle whose graph consists only of the point $(-3, 6)$.

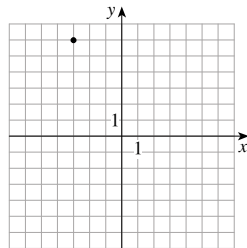

94. $x^2 + y^2 - 16x + 12y + 200 = 0 \Leftrightarrow x^2 - 16x + \left(\frac{-16}{2}\right)^2 + y^2 + 12y + \left(\frac{12}{2}\right)^2 = -200 + \left(\frac{-16}{2}\right)^2 + \left(\frac{12}{2}\right)^2$
 $\Leftrightarrow (x - 8)^2 + (y + 6)^2 = -200 + 64 + 36 = -100$. Since completing the square gives $r^2 = -100$, this is not the equation of a circle. There is no graph.

95. x -axis symmetry: $(-y) = x^4 + x^2 \Leftrightarrow y = -x^4 - x^2$, which is not the same as $y = x^4 + x^2$, so the graph is not symmetric with respect to the x -axis.

y -axis symmetry: $y = (-x)^4 + (-x)^2 = x^4 + x^2$, so the graph is symmetric with respect to the y -axis.

Origin symmetry: $(-y) = (-x)^4 + (-x)^2 \Leftrightarrow -y = x^4 + x^2$, which is not the same as $y = x^4 + x^2$, so the graph is not symmetric with respect to the origin.

96. x -axis symmetry: $x = (-y)^4 - (-y)^2 = y^4 - y^2$, so the graph is symmetric with respect to the x -axis.

y -axis symmetry: $(-x) = y^4 - y^2$, which is not the same as $x = y^4 - y^2$, so the graph is not symmetric with respect to the y -axis.

Origin symmetry: $(-x) = (-y)^4 - (-y)^2 \Leftrightarrow -x = y^4 - y^2$, which is not the same as $x = y^4 - y^2$, so the graph is not symmetric with respect to the origin.

- 97.** *x*-axis symmetry: $(-y) = x^3 + 10x \Leftrightarrow y = -x^3 - 10x$, which is not the same as $y = x^3 + 10x$, so the graph is not symmetric with respect to the *x*-axis.
y-axis symmetry: $y = (-x)^3 + 10(-x) \Leftrightarrow y = -x^3 - 10x$, which is not the same as $y = x^3 + 10x$, so the graph is not symmetric with respect to the *y*-axis.
 Origin symmetry: $(-y) = (-x)^3 + 10(-x) \Leftrightarrow -y = -x^3 - 10x \Leftrightarrow y = x^3 + 10x$, so the graph is symmetric with respect to the origin.
- 98.** *x*-axis symmetry: $(-y) = x^2 + |x| \Leftrightarrow y = -x^2 - |x|$, which is not the same as $y = x^2 + |x|$, so the graph is not symmetric with respect to the *x*-axis.
y-axis symmetry: $y = (-x)^2 + |-x| \Leftrightarrow y = x^2 + |x|$, so the graph is symmetric with respect to the *y*-axis. Note that $|-x| = |x|$.
 Origin symmetry: $(-y) = (-x)^2 + |-x| \Leftrightarrow -y = x^2 + |x| \Leftrightarrow y = -x^2 - |x|$, which is not the same as $y = x^2 + |x|$, so the graph is not symmetric with respect to the origin.
- 99.** *x*-axis symmetry: $x^4(-y)^4 + x^2(-y)^2 = 1 \Leftrightarrow x^4y^4 + x^2y^2 = 1$, so the graph is symmetric with respect to the *x*-axis.
y-axis symmetry: $(-x)^4y^4 + (-x)^2y^2 = 1 \Leftrightarrow x^4y^4 + x^2y^2 = 1$, so the graph is symmetric with respect to the *y*-axis.
 Origin symmetry: $(-x)^4(-y)^4 + (-x)^2(-y)^2 = 1 \Leftrightarrow x^4y^4 + x^2y^2 = 1$, so the graph is symmetric with respect to the origin.
- 100.** *x*-axis symmetry: $x^2(-y)^2 + x(-y) = 1 \Leftrightarrow x^2y^2 - xy = 1$, which is not the same as $x^2y^2 + xy = 1$, so the graph is not symmetric with respect to the *x*-axis.
y-axis symmetry: $(-x)^2y^2 + (-x)y = 1 \Leftrightarrow x^2y^2 - xy = 1$, which is not the same as $x^2y^2 + xy = 1$, so the graph is not symmetric with respect to the *y*-axis.
 Origin symmetry: $(-x)^2(-y)^2 + (-x)(-y) = 1 \Leftrightarrow x^2y^2 + xy = 1$, so the graph is symmetric with respect to the origin.

101. Symmetric with respect to the *y*-axis.

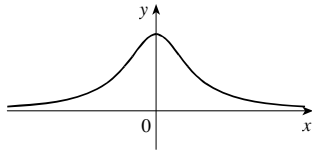

102. Symmetric with respect to the *x*-axis.

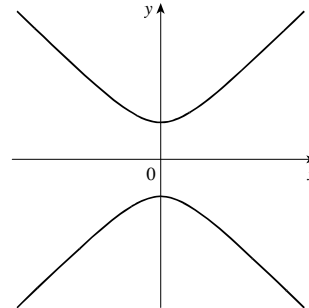

103. Symmetric with respect to the origin.

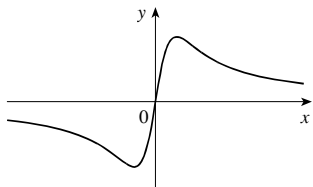

104. Symmetric with respect to the origin.

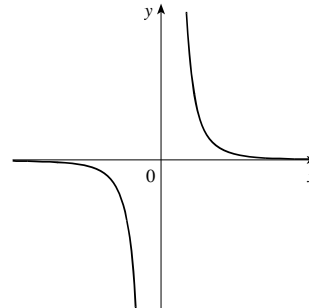

105. $\{(x, y) \mid x^2 + y^2 \leq 1\}$. This is the set of points inside (and on) the circle $x^2 + y^2 = 1$.

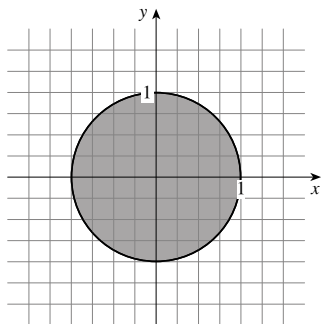

106. $\{(x, y) \mid x^2 + y^2 > 4\}$. This is the set of points outside the circle $x^2 + y^2 = 4$.

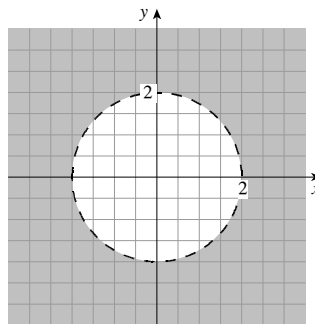

107. Completing the square gives $x^2 + y^2 - 4y - 12 = 0$

$$\Leftrightarrow x^2 + y^2 - 4y + \left(\frac{-4}{2}\right)^2 = 12 + \left(\frac{-4}{2}\right)^2 \Leftrightarrow$$

$x^2 + (y - 2)^2 = 16$. Thus, the center is $(0, 2)$, and the radius is 4. So the circle $x^2 + y^2 = 4$, with center $(0, 0)$ and radius 2, sits completely inside the larger circle. Thus, the area is $\pi 4^2 - \pi 2^2 = 16\pi - 4\pi = 12\pi$.

108. This is the top quarter of the circle of radius 3. Thus, the area is $\frac{1}{4}(9\pi) = \frac{9\pi}{4}$.

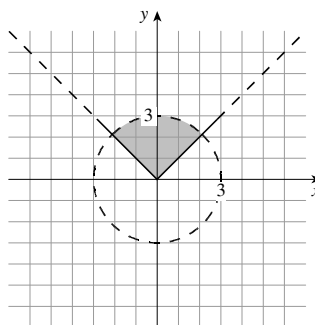

109. (a) The point $(5, 3)$ is shifted to $(5 + 3, 3 + 2) = (8, 5)$.

(b) The point (a, b) is shifted to $(a + 3, b + 2)$.

(c) Let (x, y) be the point that is shifted to $(3, 4)$. Then $(x + 3, y + 2) = (3, 4)$. Setting the x -coordinates equal, we get $x + 3 = 3 \Leftrightarrow x = 0$. Setting the y -coordinates equal, we get $y + 2 = 4 \Leftrightarrow y = 2$. So the point is $(0, 2)$.

(d) $A = (-5, -1)$, so $A' = (-5 + 3, -1 + 2) = (-2, 1)$; $B = (-3, 2)$, so $B' = (-3 + 3, 2 + 2) = (0, 4)$; and $C = (2, 1)$, so $C' = (2 + 3, 1 + 2) = (5, 3)$.

110. (a) Symmetric about the x -axis.

(b) Symmetric about the y -axis.

(c) Symmetric about the origin.

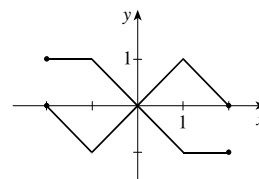
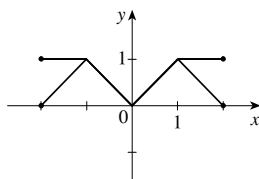
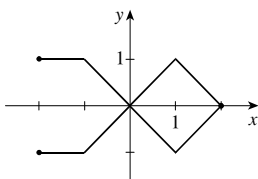

111. (a) In 1980 inflation was 14%; in 1990, it was 6%; in 1999, it was 2%.

(b) Inflation exceeded 6% from 1975 to 1976 and from 1978 to 1982.

(c) Between 1980 and 1985 the inflation rate generally decreased. Between 1987 and 1992 the inflation rate generally increased.

(d) The highest rate was about 14% in 1980. The lowest was about 1% in 2002.

112. (a) Closest: 2 Mm. Farthest: 8 Mm.

- (b) When $y = 2$ we have $\frac{(x-3)^2}{25} + \frac{2^2}{16} = 1 \Leftrightarrow \frac{(x-3)^2}{25} + \frac{1}{4} = 1 \Leftrightarrow \frac{(x-3)^2}{25} = \frac{3}{4} \Leftrightarrow (x-3)^2 = \frac{75}{4}$. Taking the square root of both sides we get $x-3 = \pm\sqrt{\frac{75}{4}} = \pm\frac{5\sqrt{3}}{2} \Leftrightarrow x = 3 \pm \frac{5\sqrt{3}}{2}$. So $x = 3 - \frac{5\sqrt{3}}{2} \approx -1.33$ or $x = 3 + \frac{5\sqrt{3}}{2} \approx 7.33$. The distance from $(-1.33, 2)$ to the center $(0, 0)$ is $d = \sqrt{(-1.33-0)^2 + (2-0)^2} = \sqrt{5.7689} \approx 2.40$. The distance from $(7.33, 2)$ to the center $(0, 0)$ is $d = \sqrt{(7.33-0)^2 + (2-0)^2} = \sqrt{57.7307} \approx 7.60$.

113. Completing the square gives $x^2 + y^2 + ax + by + c = 0 \Leftrightarrow x^2 + ax + \left(\frac{a}{2}\right)^2 + y^2 + by + \left(\frac{b}{2}\right)^2 = -c + \left(\frac{a}{2}\right)^2 + \left(\frac{b}{2}\right)^2$
 $\Leftrightarrow \left(x + \frac{a}{2}\right)^2 + \left(y + \frac{b}{2}\right)^2 = -c + \frac{a^2 + b^2}{4}$. This equation represents a circle only when $-c + \frac{a^2 + b^2}{4} > 0$. This equation represents a point when $-c + \frac{a^2 + b^2}{4} = 0$, and this equation represents the empty set when $-c + \frac{a^2 + b^2}{4} < 0$.

When the equation represents a circle, the center is $\left(-\frac{a}{2}, -\frac{b}{2}\right)$, and the radius is $\sqrt{-c + \frac{a^2 + b^2}{4}} = \frac{1}{2}\sqrt{a^2 + b^2 - 4ac}$.

114. (a) (i) $(x-2)^2 + (y-1)^2 = 9$, the center is at $(2, 1)$, and the radius is 3. $(x-6)^2 + (y-4)^2 = 16$, the center is at $(6, 4)$, and the radius is 4. The distance between centers is $\sqrt{(2-6)^2 + (1-4)^2} = \sqrt{(-4)^2 + (-3)^2} = \sqrt{16+9} = \sqrt{25} = 5$. Since $5 < 3 + 4$, these circles intersect.
- (ii) $x^2 + (y-2)^2 = 4$, the center is at $(0, 2)$, and the radius is 2. $(x-5)^2 + (y-14)^2 = 9$, the center is at $(5, 14)$, and the radius is 3. The distance between centers is $\sqrt{(0-5)^2 + (2-14)^2} = \sqrt{(-5)^2 + (-12)^2} = \sqrt{25+144} = \sqrt{169} = 13$. Since $13 > 2 + 3$, these circles do not intersect.
- (iii) $(x-3)^2 + (y+1)^2 = 1$, the center is at $(3, -1)$, and the radius is 1. $(x-2)^2 + (y-2)^2 = 25$, the center is at $(2, 2)$, and the radius is 5. The distance between centers is $\sqrt{(3-2)^2 + (-1-2)^2} = \sqrt{1^2 + (-3)^2} = \sqrt{1+9} = \sqrt{10}$. Since $\sqrt{10} < 1 + 5$, these circles intersect.
- (b) If the distance d between the centers of the circles is greater than the sum $r_1 + r_2$ of their radii, then the circles do not intersect, as shown in the first diagram. If $d = r_1 + r_2$, then the circles intersect at a single point, as shown in the second diagram. If $d < r_1 + r_2$, then the circles intersect at two points, as shown in the third diagram.

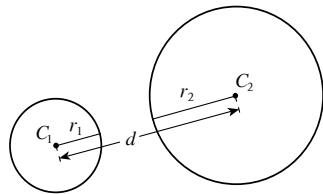

Case 1 $d > r_1 + r_2$

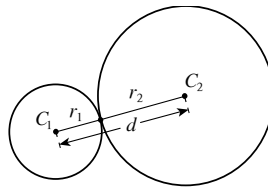

Case 2 $d = r_1 + r_2$

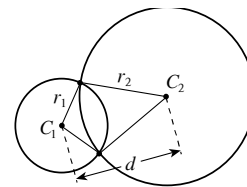

Case 3 $d < r_1 + r_2$

1.3 LINES

- We find the “steepness” or slope of a line passing through two points by dividing the difference in the y -coordinates of these points by the difference in the x -coordinates. So the line passing through the points $(0, 1)$ and $(2, 5)$ has slope $\frac{5-1}{2-0} = 2$.
- (a) The line with equation $y = 3x + 2$ has slope 3.
 (b) Any line parallel to this line has slope 3.

- (c) Any line perpendicular to this line has slope $-\frac{1}{3}$.
3. The point-slope form of the equation of the line with slope 3 passing through the point (1, 2) is $y - 2 = 3(x - 1)$.
4. For the linear equation $2x + 3y - 12 = 0$, the x -intercept is 6 and the y -intercept is 4. The equation in slope-intercept form is $y = -\frac{2}{3}x + 4$. The slope of the graph of this equation is $-\frac{2}{3}$.
5. The slope of a horizontal line is 0. The equation of the horizontal line passing through (2, 3) is $y = 3$.
6. The slope of a vertical line is undefined. The equation of the vertical line passing through (2, 3) is $x = 2$.
7. (a) Yes, the graph of $y = -3$ is a horizontal line 3 units below the x -axis.
 (b) Yes, the graph of $x = -3$ is a vertical line 3 units to the left of the y -axis.
 (c) No, a line perpendicular to a horizontal line is vertical and has undefined slope.
 (d) Yes, a line perpendicular to a vertical line is horizontal and has slope 0.

8.

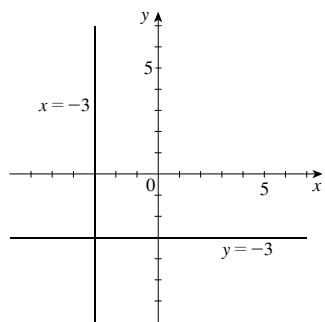
Yes, the graphs of $y = -3$ and $x = -3$ are perpendicular lines.

9. $m = \frac{y_2 - y_1}{x_2 - x_1} = \frac{0 - 2}{0 - (-1)} = \frac{-2}{1} = -2$
10. $m = \frac{y_2 - y_1}{x_2 - x_1} = \frac{-1 - 0}{3 - 0} = \frac{-1}{3} = -\frac{1}{3}$
11. $m = \frac{y_2 - y_1}{x_2 - x_1} = \frac{-1 - (-2)}{7 - 2} = \frac{1}{5}$
12. $m = \frac{y_2 - y_1}{x_2 - x_1} = \frac{-2 - 1}{3 - (-5)} = \frac{-3}{8} = -\frac{3}{8}$
13. $m = \frac{y_2 - y_1}{x_2 - x_1} = \frac{4 - 4}{0 - 5} = 0$
14. $m = \frac{y_2 - y_1}{x_2 - x_1} = \frac{-1 - 3}{1 - 4} = \frac{-4}{-3} = \frac{4}{3}$
15. $m = \frac{y_2 - y_1}{x_2 - x_1} = \frac{-5 - (-2)}{6 - 10} = \frac{-3}{-4} = \frac{3}{4}$
16. $m = \frac{y_2 - y_1}{x_2 - x_1} = \frac{-2 - (-2)}{6 - 3} = 0$
17. For ℓ_1 , we find two points, $(-1, 2)$ and $(0, 0)$ that lie on the line. Thus the slope of ℓ_1 is $m = \frac{y_2 - y_1}{x_2 - x_1} = \frac{2 - 0}{-1 - 0} = -2$.
- For ℓ_2 , we find two points $(0, 2)$ and $(2, 3)$. Thus, the slope of ℓ_2 is $m = \frac{y_2 - y_1}{x_2 - x_1} = \frac{3 - 2}{2 - 0} = \frac{1}{2}$. For ℓ_3 we find the points $(2, -2)$ and $(3, 1)$. Thus, the slope of ℓ_3 is $m = \frac{y_2 - y_1}{x_2 - x_1} = \frac{1 - (-2)}{3 - 2} = 3$. For ℓ_4 , we find the points $(-2, -1)$ and $(2, -2)$. Thus, the slope of ℓ_4 is $m = \frac{y_2 - y_1}{x_2 - x_1} = \frac{-2 - (-1)}{2 - (-2)} = \frac{-1}{4} = -\frac{1}{4}$.

18. (a)

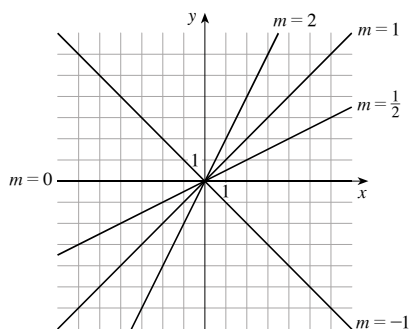

(b)

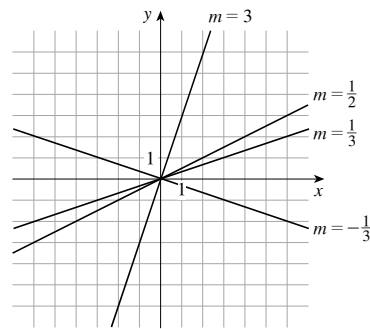

19. First we find two points $(0, 4)$ and $(4, 0)$ that lie on the line. So the slope is $m = \frac{0-4}{4-0} = -1$. Since the y -intercept is 4, the equation of the line is $y = mx + b = -1x + 4$. So $y = -x + 4$, or $x + y - 4 = 0$.
20. We find two points on the graph, $(0, 4)$ and $(-2, 0)$. So the slope is $m = \frac{0-4}{-2-0} = 2$. Since the y -intercept is 4, the equation of the line is $y = mx + b = 2x + 4$, so $y = 2x + 4 \Leftrightarrow 2x - y + 4 = 0$.
21. We choose the two intercepts as points, $(0, -3)$ and $(2, 0)$. So the slope is $m = \frac{0-(-3)}{2-0} = \frac{3}{2}$. Since the y -intercept is -3 , the equation of the line is $y = mx + b = \frac{3}{2}x - 3$, or $3x - 2y - 6 = 0$.
22. We choose the two intercepts, $(0, -4)$ and $(-3, 0)$. So the slope is $m = \frac{0-(-4)}{-3-0} = -\frac{4}{3}$. Since the y -intercept is -4 , the equation of the line is $y = mx + b = -\frac{4}{3}x - 4 \Leftrightarrow 4x + 3y + 12 = 0$.
23. Using $y = mx + b$, we have $y = 3x + (-2)$ or $3x - y - 2 = 0$.
24. Using $y = mx + b$, we have $y = \frac{2}{5}x + 4 \Leftrightarrow 2x - 5y + 20 = 0$.
25. Using the equation $y - y_1 = m(x - x_1)$, we get $y - 3 = 5(x - 2) \Leftrightarrow -5x + y = -7 \Leftrightarrow 5x - y - 7 = 0$.
26. Using the equation $y - y_1 = m(x - x_1)$, we get $y - 4 = -1(x - (-2)) \Leftrightarrow y - 4 = -x - 2 \Leftrightarrow x + y - 2 = 0$.
27. Using the equation $y - y_1 = m(x - x_1)$, we get $y - 7 = \frac{2}{3}(x - 1) \Leftrightarrow 3y - 21 = 2x - 2 \Leftrightarrow -2x + 3y = 19 \Leftrightarrow 2x - 3y + 19 = 0$.
28. Using the equation $y - y_1 = m(x - x_1)$, we get $y - (-5) = -\frac{7}{2}(x - (-3)) \Leftrightarrow 2y + 10 = -7x - 21 \Leftrightarrow 7x + 2y + 31 = 0$.
29. First we find the slope, which is $m = \frac{y_2 - y_1}{x_2 - x_1} = \frac{6-1}{1-2} = \frac{5}{-1} = -5$. Substituting into $y - y_1 = m(x - x_1)$, we get $y - 6 = -5(x - 1) \Leftrightarrow y - 6 = -5x + 5 \Leftrightarrow 5x + y - 11 = 0$.
30. First we find the slope, which is $m = \frac{y_2 - y_1}{x_2 - x_1} = \frac{3-(-2)}{4-(-1)} = \frac{5}{5} = 1$. Substituting into $y - y_1 = m(x - x_1)$, we get $y - 3 = 1(x - 4) \Leftrightarrow y - 3 = x - 4 \Leftrightarrow x - y - 1 = 0$.
31. We are given two points, $(-2, 5)$ and $(-1, -3)$. Thus, the slope is $m = \frac{y_2 - y_1}{x_2 - x_1} = \frac{-3-5}{-1-(-2)} = \frac{-8}{1} = -8$. Substituting into $y - y_1 = m(x - x_1)$, we get $y - 5 = -8[x - (-2)] \Leftrightarrow y = -8x - 11$ or $8x + y + 11 = 0$.
32. We are given two points, $(1, 7)$ and $(4, 7)$. Thus, the slope is $m = \frac{y_2 - y_1}{x_2 - x_1} = \frac{7-7}{4-1} = 0$. Substituting into $y - y_1 = m(x - x_1)$, we get $y - 7 = 0(x - 1) \Leftrightarrow y = 7$ or $y - 7 = 0$.
33. We are given two points, $(1, 0)$ and $(0, -3)$. Thus, the slope is $m = \frac{y_2 - y_1}{x_2 - x_1} = \frac{-3-0}{0-1} = \frac{-3}{-1} = 3$. Using the y -intercept, we have $y = 3x + (-3)$ or $y = 3x - 3$ or $3x - y - 3 = 0$.
34. We are given two points, $(-8, 0)$ and $(0, 6)$. Thus, the slope is $m = \frac{y_2 - y_1}{x_2 - x_1} = \frac{6-0}{0-(-8)} = \frac{6}{8} = \frac{3}{4}$. Using the y -intercept we have $y = \frac{3}{4}x + 6 \Leftrightarrow 3x - 4y + 24 = 0$.
35. Since the equation of a line with slope 0 passing through (a, b) is $y = b$, the equation of this line is $y = 3$.
36. Since the equation of a line with undefined slope passing through (a, b) is $x = a$, the equation of this line is $x = -1$.
37. Since the equation of a line with undefined slope passing through (a, b) is $x = a$, the equation of this line is $x = 2$.
38. Since the equation of a line with slope 0 passing through (a, b) is $y = b$, the equation of this line is $y = 1$.
39. Any line parallel to $y = 3x - 5$ has slope 3. The desired line passes through $(1, 2)$, so substituting into $y - y_1 = m(x - x_1)$, we get $y - 2 = 3(x - 1) \Leftrightarrow y = 3x - 1$ or $3x - y - 1 = 0$.
40. Any line perpendicular to $y = -\frac{1}{2}x + 7$ has slope $-\frac{1}{-1/2} = 2$. The desired line passes through $(-3, 2)$, so substituting into $y - y_1 = m(x - x_1)$, we get $y - 2 = 2[x - (-3)] \Leftrightarrow y = 2x + 8$ or $2x - y + 8 = 0$.

41. Since the equation of a horizontal line passing through (a, b) is $y = b$, the equation of the horizontal line passing through $(4, 5)$ is $y = 5$.
42. Any line parallel to the y -axis has undefined slope and an equation of the form $x = a$. Since the graph of the line passes through the point $(4, 5)$, the equation of the line is $x = 4$.
43. Since $x + 2y = 6 \Leftrightarrow 2y = -x + 6 \Leftrightarrow y = -\frac{1}{2}x + 3$, the slope of this line is $-\frac{1}{2}$. Thus, the line we seek is given by $y - (-6) = -\frac{1}{2}(x - 1) \Leftrightarrow 2y + 12 = -x + 1 \Leftrightarrow x + 2y + 11 = 0$.
44. Since $2x + 3y + 4 = 0 \Leftrightarrow 3y = -2x - 4 \Leftrightarrow y = -\frac{2}{3}x - \frac{4}{3}$, the slope of this line is $m = -\frac{2}{3}$. Substituting $m = -\frac{2}{3}$ and $b = 6$ into the slope-intercept formula, the line we seek is given by $y = -\frac{2}{3}x + 6 \Leftrightarrow 2x + 3y - 18 = 0$.
45. Any line parallel to $x = 5$ has undefined slope and an equation of the form $x = a$. Thus, an equation of the line is $x = -1$.
46. Any line perpendicular to $y = 1$ has undefined slope and an equation of the form $x = a$. Since the graph of the line passes through the point $(2, 6)$, an equation of the line is $x = 2$.
47. First find the slope of $2x + 5y + 8 = 0$. This gives $2x + 5y + 8 = 0 \Leftrightarrow 5y = -2x - 8 \Leftrightarrow y = -\frac{2}{5}x - \frac{8}{5}$. So the slope of the line that is perpendicular to $2x + 5y + 8 = 0$ is $m = -\frac{1}{-2/5} = \frac{5}{2}$. The equation of the line we seek is $y - (-2) = \frac{5}{2}(x - (-1)) \Leftrightarrow 2y + 4 = 5x + 5 \Leftrightarrow 5x - 2y + 1 = 0$.
48. First find the slope of the line $4x - 8y = 1$. This gives $4x - 8y = 1 \Leftrightarrow -8y = -4x + 1 \Leftrightarrow y = \frac{1}{2}x - \frac{1}{8}$. So the slope of the line that is perpendicular to $4x - 8y = 1$ is $m = -\frac{1}{1/2} = -2$. The equation of the line we seek is $y - \left(-\frac{2}{3}\right) = -2\left(x - \frac{1}{2}\right) \Leftrightarrow y + \frac{2}{3} = -2x + 1 \Leftrightarrow 6x + 3y - 1 = 0$.
49. First find the slope of the line passing through $(2, 5)$ and $(-2, 1)$. This gives $m = \frac{1 - 5}{-2 - 2} = \frac{-4}{-4} = 1$, and so the equation of the line we seek is $y - 7 = 1(x - 1) \Leftrightarrow x - y + 6 = 0$.
50. First find the slope of the line passing through $(1, 1)$ and $(5, -1)$. This gives $m = \frac{-1 - 1}{5 - 1} = \frac{-2}{4} = -\frac{1}{2}$, and so the slope of the line that is perpendicular is $m = -\frac{1}{-1/2} = 2$. Thus the equation of the line we seek is $y + 11 = 2(x + 2) \Leftrightarrow 2x - y - 7 = 0$.

51. (a)

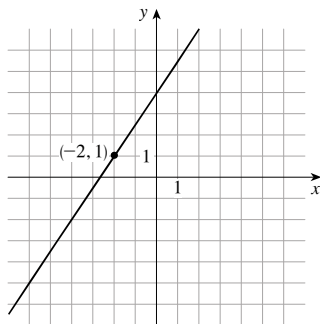

(b) $y - 1 = \frac{3}{2}(x - (-2)) \Leftrightarrow 2y - 2 = 3(x + 2) \Leftrightarrow 2y - 2 = 3x + 6 \Leftrightarrow 3x - 2y + 8 = 0$.

52. (a)

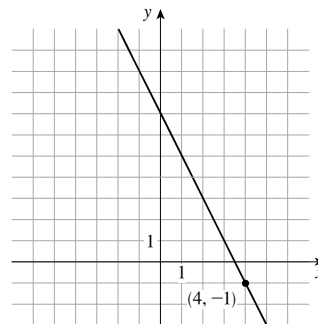

(b) $y - (-1) = -2(x - 4) \Leftrightarrow y + 1 = -2x + 8 \Leftrightarrow 2x + y - 7 = 0$.

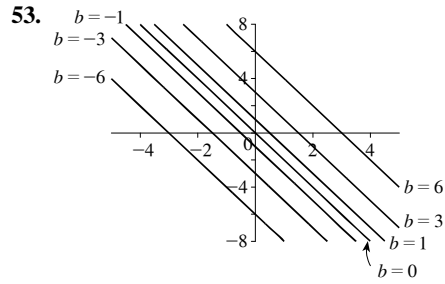

$y = -2x + b$, $b = 0, \pm 1, \pm 3, \pm 6$. They have the same slope, so they are parallel.

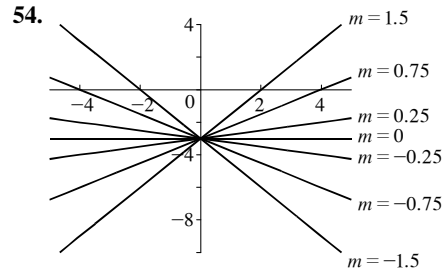

$y = mx - 3$, $m = 0, \pm 0.25, \pm 0.75, \pm 1.5$. Each of the lines contains the point $(0, -3)$ because the point $(0, -3)$ satisfies each equation $y = mx - 3$. Since $(0, -3)$ is on the y-axis, they all have the same y-intercept.

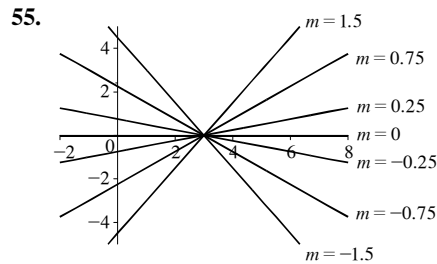

$y = m(x - 3)$, $m = 0, \pm 0.25, \pm 0.75, \pm 1.5$. Each of the lines contains the point $(3, 0)$ because the point $(3, 0)$ satisfies each equation $y = m(x - 3)$. Since $(3, 0)$ is on the x-axis, we could also say that they all have the same x-intercept.

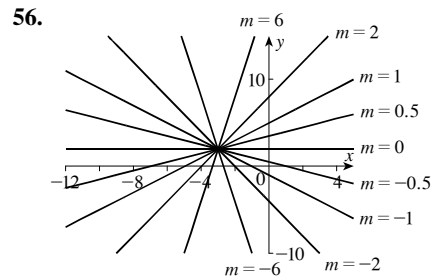

$y = 2 + m(x + 3)$, $m = 0, \pm 0.5, \pm 1, \pm 2, \pm 6$. Each of the lines contains the point $(-3, 2)$ because the point $(-3, 2)$ satisfies each equation $y = 2 + m(x + 3)$.

57. $y = 3 - x = -x + 3$. So the slope is -1 and the y-intercept is 3 .

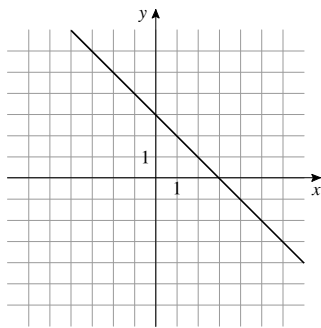

58. $y = \frac{2}{3}x - 2$. So the slope is $\frac{2}{3}$ and the y-intercept is -2 .

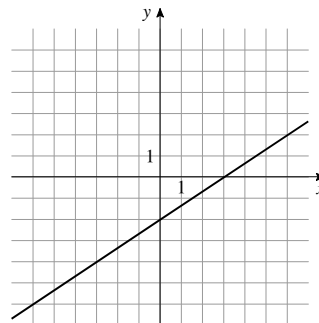

59. $-2x + y = 7 \Leftrightarrow y = 2x + 7$. So the slope is 2 and the y-intercept is 7.

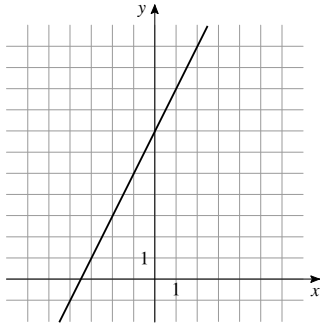

60. $2x - 5y = 0 \Leftrightarrow -5y = -2x \Leftrightarrow y = \frac{2}{5}x$. So the slope is $\frac{2}{5}$ and the y-intercept is 0.

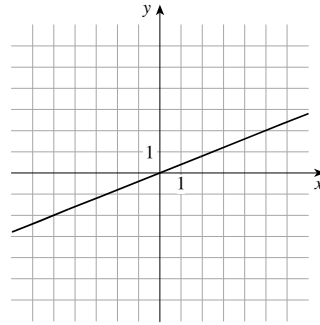

61. $4x + 5y = 10 \Leftrightarrow 5y = -4x + 10 \Leftrightarrow y = -\frac{4}{5}x + 2$. So the slope is $-\frac{4}{5}$ and the y-intercept is 2.

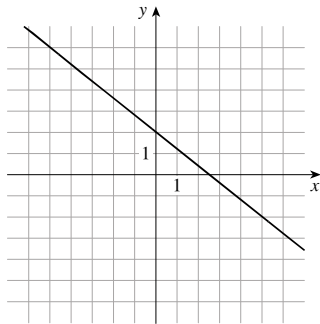

62. $3x - 4y = 12 \Leftrightarrow -4y = -3x + 12 \Leftrightarrow y = \frac{3}{4}x - 3$. So the slope is $\frac{3}{4}$ and the y-intercept is -3.

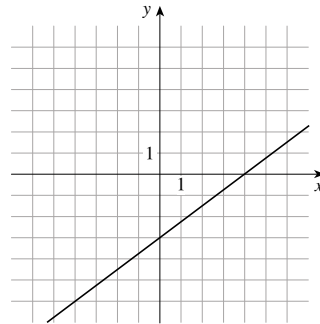

63. $y = 4$ can also be expressed as $y = 0x + 4$. So the slope is 0 and the y-intercept is 4.

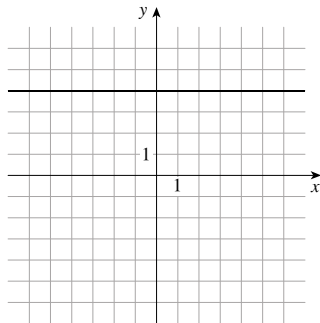

64. $x = -5$ cannot be expressed in the form $y = mx + b$. So the slope is undefined, and there is no y-intercept. This is a vertical line.

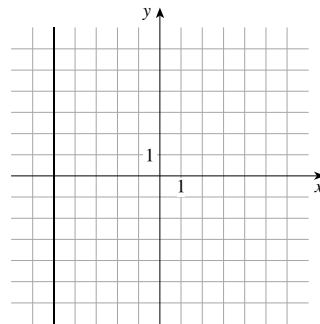

65. $x = 3$ cannot be expressed in the form $y = mx + b$. So the slope is undefined, and there is no y -intercept. This is a vertical line.

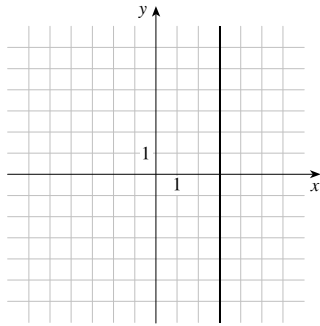

66. $y = -2$ can also be expressed as $y = 0x - 2$. So the slope is 0 and the y -intercept is -2 .

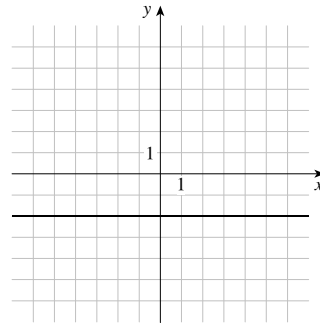

67. $5x + 2y - 10 = 0$. To find x -intercepts, we set $y = 0$ and solve for x : $5x + 2(0) - 10 = 0 \Leftrightarrow 5x = 10 \Leftrightarrow x = 2$, so the x -intercept is 2.

To find y -intercepts, we set $x = 0$ and solve for y : $5(0) + 2y - 10 = 0 \Leftrightarrow 2y = 10 \Leftrightarrow y = 5$, so the y -intercept is 5.

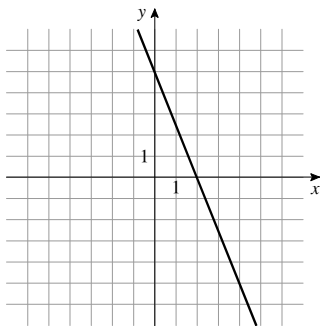

68. $6x - 7y - 42 = 0$. To find x -intercepts, we set $y = 0$ and solve for x : $6x - 7(0) - 42 = 0 \Leftrightarrow 6x = 42 \Leftrightarrow x = 7$, so the x -intercept is 7.

To find y -intercepts, we set $x = 0$ and solve for y : $6(0) - 7y - 42 = 0 \Leftrightarrow 7y = -42 \Leftrightarrow y = -6$, so the y -intercept is -6 .

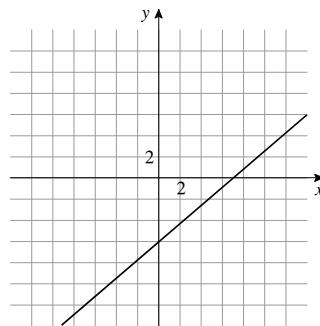

69. $\frac{1}{2}x - \frac{1}{3}y + 1 = 0$. To find x -intercepts, we set $y = 0$ and solve for x : $\frac{1}{2}x - \frac{1}{3}(0) + 1 = 0 \Leftrightarrow \frac{1}{2}x = -1 \Leftrightarrow x = -2$, so the x -intercept is -2 .

To find y -intercepts, we set $x = 0$ and solve for y :

$$\frac{1}{2}(0) - \frac{1}{3}y + 1 = 0 \Leftrightarrow \frac{1}{3}y = 1 \Leftrightarrow y = 3, \text{ so the } y\text{-intercept is } 3.$$

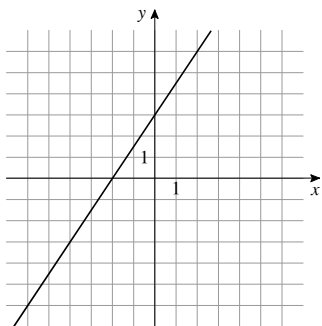

70. $\frac{1}{3}x - \frac{1}{5}y - 2 = 0$. To find x -intercepts, we set $y = 0$ and solve for x : $\frac{1}{3}x - \frac{1}{5}(0) - 2 = 0 \Leftrightarrow \frac{1}{3}x = 2 \Leftrightarrow x = 6$, so the x -intercept is 6.

To find y -intercepts, we set $x = 0$ and solve for y :

$$\frac{1}{3}(0) - \frac{1}{5}y - 2 = 0 \Leftrightarrow \frac{1}{5}y = -2 \Leftrightarrow y = -10, \text{ so the } y\text{-intercept is } -10.$$

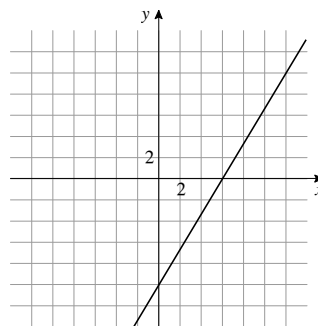

71. $y = 6x + 4$. To find x -intercepts, we set $y = 0$ and solve for x : $0 = 6x + 4 \Leftrightarrow 6x = -4 \Leftrightarrow x = -\frac{2}{3}$, so the x -intercept is $-\frac{2}{3}$.

To find y -intercepts, we set $x = 0$ and solve for y :

$$y = 6(0) + 4 = 4, \text{ so the } y\text{-intercept is } 4.$$

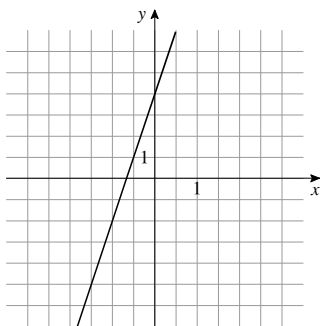

72. $y = -4x - 10$. To find x -intercepts, we set $y = 0$ and solve for x : $0 = -4x - 10 \Leftrightarrow 4x = -10 \Leftrightarrow x = -\frac{5}{2}$, so the x -intercept is $-\frac{5}{2}$.

To find y -intercepts, we set $x = 0$ and solve for y :

$$y = -4(0) - 10 = -10, \text{ so the } y\text{-intercept is } -10.$$

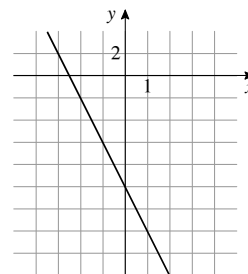

73. To determine if the lines are parallel or perpendicular, we find their slopes. The line with equation $y = 2x + 3$ has slope 2. The line with equation $2y - 4x - 5 = 0 \Leftrightarrow 2y = 4x + 5 \Leftrightarrow y = 2x + \frac{5}{2}$ also has slope 2, and so the lines are parallel.

74. To determine if the lines are parallel or perpendicular, we find their slopes. The line with equation $y = \frac{1}{2}x + 4$ has slope $\frac{1}{2}$. The line with equation $2x + 4y = 1 \Leftrightarrow 4y = -2x - 1 \Leftrightarrow y = -\frac{1}{2}x - \frac{1}{4}$ has slope $-\frac{1}{2} \neq -\frac{1}{1/2}$, and so the lines are neither parallel nor perpendicular.

75. To determine if the lines are parallel or perpendicular, we find their slopes. The line with equation $-3x + 4y = 4 \Leftrightarrow 4y = 3x + 4 \Leftrightarrow y = \frac{3}{4}x + 1$ has slope $\frac{3}{4}$. The line with equation $4x + 3y = 5 \Leftrightarrow 3y = -4x + 5 \Leftrightarrow y = -\frac{4}{3}x + \frac{5}{3}$ has slope $-\frac{4}{3} = -\frac{1}{3/4}$, and so the lines are perpendicular.

76. To determine if the lines are parallel or perpendicular, we find their slopes. The line with equation $2x - 3y = 10 \Leftrightarrow 3y = 2x - 10 \Leftrightarrow y = \frac{2}{3}x - \frac{10}{3}$ has slope $\frac{2}{3}$. The line with equation $3y - 2x - 7 = 0 \Leftrightarrow 3y = 2x + 7 \Leftrightarrow y = \frac{2}{3}x + \frac{7}{3}$ also has slope $\frac{2}{3}$, and so the lines are parallel.

77. To determine if the lines are parallel or perpendicular, we find their slopes. The line with equation $7x - 3y = 2 \Leftrightarrow 3y = 7x - 2 \Leftrightarrow y = \frac{7}{3}x - \frac{2}{3}$ has slope $\frac{7}{3}$. The line with equation $9y + 21x = 1 \Leftrightarrow 9y = -21x - 1 \Leftrightarrow y = -\frac{7}{3} - \frac{1}{9}$ has slope $-\frac{7}{3} \neq -\frac{1}{7/3}$, and so the lines are neither parallel nor perpendicular.

78. To determine if the lines are parallel or perpendicular, we find their slopes. The line with equation $6y - 2x = 5 \Leftrightarrow 6y = 2x + 5 \Leftrightarrow y = \frac{1}{3}x + \frac{5}{6}$ has slope $\frac{1}{3}$. The line with equation $2y + 6x = 1 \Leftrightarrow 2y = -6x - 1 \Leftrightarrow y = -3x - \frac{1}{2}$ has slope $-3 = -\frac{1}{1/3}$, and so the lines are perpendicular.

79. We first plot the points to find the pairs of points that determine each side. Next we find the slopes of opposite sides. The slope of AB is $\frac{4-1}{7-1} = \frac{3}{6} = \frac{1}{2}$, and the slope of DC is $\frac{10-7}{5-(-1)} = \frac{3}{6} = \frac{1}{2}$. Since these slope are equal, these two sides are parallel. The slope of AD is $\frac{7-1}{-1-1} = \frac{6}{-2} = -3$, and the slope of BC is $\frac{10-4}{5-7} = \frac{6}{-2} = -3$. Since these slope are equal, these two sides are parallel. Hence $ABCD$ is a parallelogram.

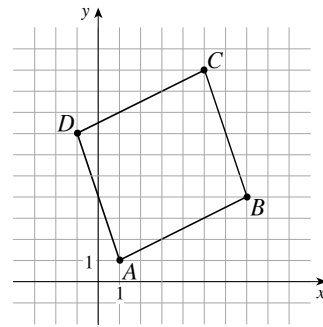

80. We first plot the points to determine the perpendicular sides. Next find the slopes of the sides. The slope of AB is $\frac{3-(-1)}{3-(-3)} = \frac{4}{6} = \frac{2}{3}$, and the slope of AC is $\frac{8-(-1)}{-9-(-3)} = \frac{9}{-6} = -\frac{3}{2}$. Since $(\text{slope of } AB) \times (\text{slope of } AC) = \left(\frac{2}{3}\right) \left(-\frac{3}{2}\right) = -1$, the sides are perpendicular, and ABC is a right triangle.

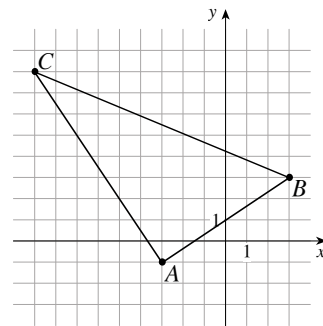

81. We first plot the points to find the pairs of points that determine each side. Next we find the slopes of opposite sides. The slope of AB is $\frac{3-1}{11-1} = \frac{2}{10} = \frac{1}{5}$ and the slope of DC is $\frac{6-8}{0-10} = \frac{-2}{-10} = \frac{1}{5}$. Since these slope are equal, these two sides are parallel. Slope of AD is $\frac{6-1}{0-1} = \frac{5}{-1} = -5$, and the slope of BC is $\frac{3-8}{11-10} = \frac{-5}{1} = -5$. Since these slope are equal, these two sides are parallel. Since $(\text{slope of } AB) \times (\text{slope of } AD) = \frac{1}{5} \times (-5) = -1$, the first two sides are each perpendicular to the second two sides. So the sides form a rectangle.

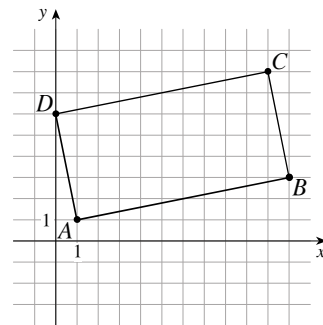

82. (a) The slope of the line passing through $(1, 1)$ and $(3, 9)$ is $\frac{9-1}{3-1} = \frac{8}{2} = 4$. The slope of the line passing through $(1, 1)$ and $(6, 21)$ is $\frac{21-1}{6-1} = \frac{20}{5} = 4$. Since the slopes are equal, the points are collinear.

- (b) The slope of the line passing through $(-1, 3)$ and $(1, 7)$ is $\frac{7-3}{1-(-1)} = \frac{4}{2} = 2$. The slope of the line passing through $(-1, 3)$ and $(4, 15)$ is $\frac{15-3}{4-(-1)} = \frac{12}{5}$. Since the slopes are not equal, the points are not collinear.
83. We need the slope and the midpoint of the line AB . The midpoint of AB is $\left(\frac{1+7}{2}, \frac{4-2}{2}\right) = (4, 1)$, and the slope of AB is $m = \frac{-2-4}{7-1} = \frac{-6}{6} = -1$. The slope of the perpendicular bisector will have slope $\frac{-1}{m} = \frac{-1}{-1} = 1$. Using the point-slope form, the equation of the perpendicular bisector is $y - 1 = 1(x - 4)$ or $x - y - 3 = 0$.
84. We find the intercepts (the length of the sides). When $x = 0$, we have $2y + 3(0) - 6 = 0 \Leftrightarrow 2y = 6 \Leftrightarrow y = 3$, and when $y = 0$, we have $2(0) + 3x - 6 = 0 \Leftrightarrow 3x = 6 \Leftrightarrow x = 2$. Thus, the area of the triangle is $\frac{1}{2}(3)(2) = 3$.
85. (a) We start with the two points $(a, 0)$ and $(0, b)$. The slope of the line that contains them is $\frac{b-0}{0-a} = -\frac{b}{a}$. So the equation of the line containing them is $y = -\frac{b}{a}x + b$ (using the slope-intercept form). Dividing by b (since $b \neq 0$) gives $\frac{y}{b} = -\frac{x}{a} + 1 \Leftrightarrow \frac{x}{a} + \frac{y}{b} = 1$.
- (b) Setting $a = 6$ and $b = -8$, we get $\frac{x}{6} + \frac{y}{-8} = 1 \Leftrightarrow 4x - 3y = 24 \Leftrightarrow 4x - 3y - 24 = 0$.
86. (a) The line tangent at $(3, -4)$ will be perpendicular to the line passing through the points $(0, 0)$ and $(3, -4)$. The slope of this line is $\frac{-4-0}{3-0} = -\frac{4}{3}$. Thus, the slope of the tangent line will be $-\frac{1}{(-4/3)} = \frac{3}{4}$. Then the equation of the tangent line is $y - (-4) = \frac{3}{4}(x - 3) \Leftrightarrow 4(y + 4) = 3(x - 3) \Leftrightarrow 3x - 4y - 25 = 0$.
- (b) Since diametrically opposite points on the circle have parallel tangent lines, the other point is $(-3, 4)$.
87. (a) The slope represents an increase of 0.02°C every year. The T -intercept is the average surface temperature in 1950, or 15°C .
- (b) In 2050, $t = 2050 - 1950 = 100$, so $T = 0.02(100) + 15 = 17$ degrees Celsius.
88. (a) The slope is $0.0417D = 0.0417(200) = 8.34$. It represents the increase in dosage for each one-year increase in the child's age.
- (b) When $a = 0$, $c = 8.34(0 + 1) = 8.34$ mg.

89. (a)

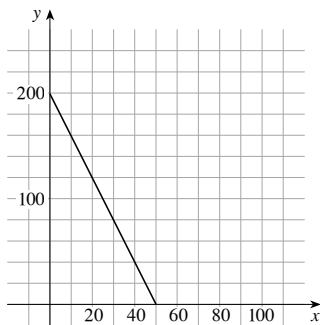

- (b) The slope, -4 , represents the decline in number of spaces sold for each \$1 increase in rent. The y -intercept is the number of spaces at the flea market, 200, and the x -intercept is the cost per space when the manager rents no spaces, \$50.

90. (a)

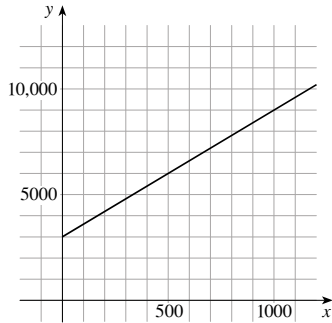

(b) The slope is the cost per toaster oven, \$6. The y-intercept, \$3000, is the monthly fixed cost—the cost that is incurred no matter how many toaster ovens are produced.

91. (a)

C	-30°	-20°	-10°	0°	10°	20°	30°
F	-22°	-4°	14°	32°	50°	68°	86°

(b) Substituting a for both F and C, we have

$$a = \frac{9}{5}a + 32 \Leftrightarrow -\frac{4}{5}a = 32 \Leftrightarrow$$

$$a = -40^\circ. \text{ Thus both scales agree at } -40^\circ.$$

92. (a) Using n in place of x and t in place of y , we find that the slope is $\frac{t_2 - t_1}{n_2 - n_1} = \frac{80 - 70}{168 - 120} = \frac{10}{48} = \frac{5}{24}$. So the linear

$$\text{equation is } t - 80 = \frac{5}{24}(n - 168) \Leftrightarrow t - 80 = \frac{5}{24}n - 35 \Leftrightarrow t = \frac{5}{24}n + 45.$$

(b) When $n = 150$, the temperature is approximately given by $t = \frac{5}{24}(150) + 45 = 76.25^\circ \text{ F} \approx 76^\circ \text{ F}$.

93. (a) Using t in place of x and V in place of y , we find the slope of the line using the points $(0, 4000)$ and $(4, 200)$. Thus, the slope is

$$m = \frac{200 - 4000}{4 - 0} = \frac{-3800}{4} = -950. \text{ Using the } V\text{-intercept, the}$$

linear equation is $V = -950t + 4000$.

(c) The slope represents a decrease of \$950 each year in the value of the computer. The V -intercept represents the cost of the computer.

(d) When $t = 3$, the value of the computer is given by $V = -950(3) + 4000 = 1150$.

(b)

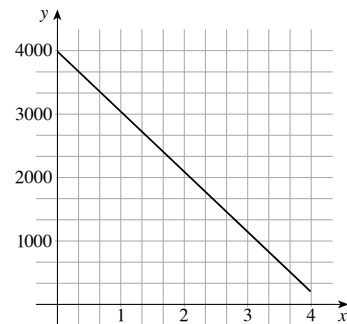

94. (a) We are given $\frac{\text{change in pressure}}{10 \text{ feet change in depth}} = \frac{4.34}{10} = 0.434$. Using P for

pressure and d for depth, and using the point $P = 15$ when $d = 0$, we have $P - 15 = 0.434(d - 0) \Leftrightarrow P = 0.434d + 15$.

(c) The slope represents the increase in pressure per foot of descent. The y -intercept represents the pressure at the surface.

(d) When $P = 100$, then $100 = 0.434d + 15 \Leftrightarrow 0.434d = 85 \Leftrightarrow d = 195.9 \text{ ft}$. Thus the pressure is 100 lb/in^3 at a depth of approximately 196 ft.

(b)

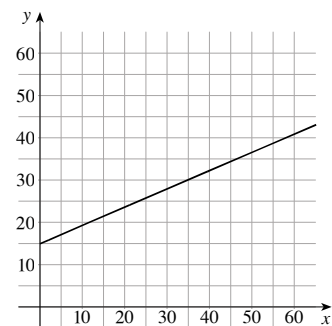

95. The temperature is increasing at a constant rate when the slope is positive, decreasing at a constant rate when the slope is negative, and constant when the slope is 0.

96. We label the three points A , B , and C . If the slope of the line segment \overline{AB} is equal to the slope of the line segment \overline{BC} , then the points A , B , and C are collinear. Using the distance formula, we find the distance between A and B , between B and C , and between A and C . If the sum of the two smaller distances equals the largest distance, the points A , B , and C are collinear.

Another method: Find an equation for the line through A and B . Then check if C satisfies the equation. If so, the points are collinear.

1.4 SOLVING QUADRATIC EQUATIONS

1. (a) The Quadratic Formula states that $x = \frac{-b \pm \sqrt{b^2 - 4ac}}{2a}$.

(b) In the equation $\frac{1}{2}x^2 - x - 4 = 0$, $a = \frac{1}{2}$, $b = -1$, and $c = -4$. So, the solution of the equation is

$$x = \frac{-(-1) \pm \sqrt{(-1)^2 - 4\left(\frac{1}{2}\right)(-4)}}{2\left(\frac{1}{2}\right)} = \frac{1 \pm 3}{1} = -2 \text{ or } 4.$$

2. (a) To solve the equation $x^2 - 4x - 5 = 0$ by factoring, we write $x^2 - 4x - 5 = (x - 5)(x + 1) = 0$ and use the Zero-Product Property to get $x = 5$ or $x = -1$.

(b) To solve by completing the square, we add 5 to both sides to get $x^2 - 4x = 5$, and then add $\left(-\frac{4}{2}\right)^2$ to both sides to get $x^2 - 4x + 4 = 5 + 4 \Leftrightarrow (x - 2)^2 = 9 \Leftrightarrow x - 2 = \pm 3 \Leftrightarrow x = 5$ or $x = -1$.

(c) To solve using the Quadratic Formula, we substitute $a = 1$, $b = -4$, and $c = -5$, obtaining

$$x = \frac{-(-4) \pm \sqrt{(-4)^2 - 4(1)(-5)}}{2(1)} = \frac{4 \pm \sqrt{36}}{2} = 2 \pm 3 \Leftrightarrow x = 5 \text{ or } x = -1.$$

3. For the quadratic equation $ax^2 + bx + c = 0$ the discriminant is $D = b^2 - 4ac$. If $D > 0$, the equation has two real solutions; if $D = 0$, the equation has one real solution; and if $D < 0$, the equation has no real solution.

4. There are many possibilities. For example, $x^2 = 1$ has two solutions, $x^2 = 0$ has one solution, and $x^2 = -1$ has no solution.

5. $x^2 - 8x + 15 = 0 \Leftrightarrow (x - 3)(x - 5) = 0 \Leftrightarrow x - 3 = 0$ or $x - 5 = 0$. Thus, $x = 3$ or $x = 5$.

6. $x^2 + 5x + 6 = 0 \Leftrightarrow (x + 3)(x + 2) = 0 \Leftrightarrow x + 3 = 0$ or $x + 2 = 0$. Thus, $x = -3$ or $x = -2$.

7. $x^2 - x = 6 \Leftrightarrow x^2 - x - 6 = 0 \Leftrightarrow (x + 2)(x - 3) = 0 \Leftrightarrow x + 2 = 0$ or $x - 3 = 0$. Thus, $x = -2$ or $x = 3$.

8. $x^2 - 4x = 21 \Leftrightarrow x^2 - 4x - 21 = 0 \Leftrightarrow (x + 3)(x - 7) = 0 \Leftrightarrow x + 3 = 0$ or $x - 7 = 0$. Thus, $x = -3$ or $x = 7$.

9. $5x^2 - 9x - 2 = 0 \Leftrightarrow (5x + 1)(x - 2) = 0 \Leftrightarrow 5x + 1 = 0$ or $x - 2 = 0$. Thus, $x = -\frac{1}{5}$ or $x = 2$.

10. $6x^2 - x - 12 = 0 \Leftrightarrow (3x + 4)(2x - 3) = 0 \Leftrightarrow 3x + 4 = 0$ or $2x - 3 = 0$. Thus, $x = -\frac{4}{3}$ or $x = \frac{3}{2}$.

11. $2s^2 = 5s + 3 \Leftrightarrow 2s^2 - 5s - 3 = 0 \Leftrightarrow (2s + 1)(s - 3) = 0 \Leftrightarrow 2s + 1 = 0$ or $s - 3 = 0$. Thus, $s = -\frac{1}{2}$ or $s = 3$.

12. $4y^2 - 9y = 28 \Leftrightarrow 4y^2 - 9y - 28 = 0 \Leftrightarrow (4y + 7)(y - 4) = 0 \Leftrightarrow 4y + 7 = 0$ or $y - 4 = 0$. Thus, $y = -\frac{7}{4}$ or $y = 4$.

13. $12z^2 - 44z = 45 \Leftrightarrow 12z^2 - 44z - 45 = 0 \Leftrightarrow (6z + 5)(2z - 9) = 0 \Leftrightarrow 6z + 5 = 0$ or $2z - 9 = 0$. Thus, $z = -\frac{5}{6}$ or $z = \frac{9}{2}$.

14. $4w^2 = 4w + 3 \Leftrightarrow 4w^2 - 4w - 3 = 0 \Leftrightarrow (2w + 1)(2w - 3) = 0 \Leftrightarrow 2w + 1 = 0$ or $2w - 3 = 0$. If $2w + 1 = 0$, then $w = -\frac{1}{2}$; if $2w - 3 = 0$, then $w = \frac{3}{2}$.

15. $x^2 = 5(x + 100) \Leftrightarrow x^2 = 5x + 500 \Leftrightarrow x^2 - 5x - 500 = 0 \Leftrightarrow (x - 25)(x + 20) = 0 \Leftrightarrow x - 25 = 0$ or $x + 20 = 0$. Thus, $x = 25$ or $x = -20$.

16. $6x(x - 1) = 21 - x \Leftrightarrow 6x^2 - 6x = 21 - x \Leftrightarrow 6x^2 - 5x - 21 = 0 \Leftrightarrow (2x + 3)(3x - 7) = 0 \Leftrightarrow 2x + 3 = 0$ or $3x - 7 = 0$. If $2x + 3 = 0$, then $x = -\frac{3}{2}$; if $3x - 7 = 0$, then $x = \frac{7}{3}$.

17. $x^2 - 8x + 1 = 0 \Leftrightarrow x^2 - 8x = -1 \Leftrightarrow x^2 - 8x + 16 = -1 + 16 \Leftrightarrow (x - 4)^2 = 15 \Leftrightarrow x - 4 = \pm\sqrt{15} \Leftrightarrow x = 4 \pm \sqrt{15}$.
18. $x^2 + 6x - 2 = 0 \Leftrightarrow x^2 + 6x = 2 \Leftrightarrow x^2 + 6x + 9 = 2 + 9 \Leftrightarrow (x + 3)^2 = 11 \Leftrightarrow x + 3 = \pm\sqrt{11} \Leftrightarrow x = -3 \pm \sqrt{11}$.
19. $x^2 - 6x - 11 = 0 \Leftrightarrow x^2 - 6x = 11 \Leftrightarrow x^2 - 6x + 9 = 11 + 9 \Leftrightarrow (x - 3)^2 = 20 \Rightarrow x - 3 = \pm 2\sqrt{5} \Leftrightarrow x = 3 \pm 2\sqrt{5}$.
20. $x^2 + 3x - \frac{7}{4} = 0 \Leftrightarrow x^2 + 3x = \frac{7}{4} \Leftrightarrow x^2 + 3x + \frac{9}{4} = \frac{7}{4} + \frac{9}{4} \Leftrightarrow \left(x + \frac{3}{2}\right)^2 = \frac{16}{4} = 4 \Rightarrow x + \frac{3}{2} = \pm 2 \Leftrightarrow x = -\frac{3}{2} \pm 2 \Leftrightarrow x = \frac{1}{2} \text{ or } x = -\frac{7}{2}$.
21. $x^2 + x - \frac{3}{4} = 0 \Leftrightarrow x^2 + x = \frac{3}{4} \Leftrightarrow x^2 + x + \frac{1}{4} = \frac{3}{4} + \frac{1}{4} \Leftrightarrow \left(x + \frac{1}{2}\right)^2 = 1 \Rightarrow x + \frac{1}{2} = \pm 1 \Leftrightarrow x = -\frac{1}{2} \pm 1$. So $x = -\frac{1}{2} - 1 = -\frac{3}{2}$ or $x = -\frac{1}{2} + 1 = \frac{1}{2}$.
22. $x^2 - 5x + 1 = 0 \Leftrightarrow x^2 - 5x = -1 \Leftrightarrow x^2 - 5x + \frac{25}{4} = -1 + \frac{25}{4} \Leftrightarrow \left(x - \frac{5}{2}\right)^2 = \frac{21}{4} \Rightarrow x - \frac{5}{2} = \pm\sqrt{\frac{21}{4}} = \pm\frac{\sqrt{21}}{2} \Leftrightarrow x = \frac{5}{2} \pm \frac{\sqrt{21}}{2}$.
23. $x^2 + 22x + 21 = 0 \Leftrightarrow x^2 + 22x = -21 \Leftrightarrow x^2 + 22x + 11^2 = -21 + 11^2 = -21 + 121 \Leftrightarrow (x + 11)^2 = 100 \Rightarrow x + 11 = \pm 10 \Leftrightarrow x = -11 \pm 10$. Thus, $x = -1$ or $x = -21$.
24. $x^2 - 18x = 19 \Leftrightarrow x^2 - 18x + (-9)^2 = 19 + (-9)^2 = 19 + 81 \Leftrightarrow (x - 9)^2 = 100 \Rightarrow x - 9 = \pm 10 \Leftrightarrow x = 9 \pm 10$, so $x = -1$ or $x = 19$.
25. $5x^2 + 10x - 7 = 0 \Leftrightarrow x^2 + 2x - \frac{7}{5} = 0 \Leftrightarrow x^2 + 2x = \frac{7}{5} \Leftrightarrow x^2 + 2x + 1 = \frac{7}{5} + 1 \Leftrightarrow (x + 1)^2 = \frac{12}{5} \Leftrightarrow x + 1 = \pm\sqrt{\frac{12}{5}} \Leftrightarrow x = -1 \pm \frac{2\sqrt{15}}{5}$.
26. $2x^2 + 16x + 5 = 0 \Leftrightarrow x^2 + 8x + \frac{5}{2} = 0 \Leftrightarrow x^2 + 8x = -\frac{5}{2} \Leftrightarrow x^2 + 8x + 16 = -\frac{5}{2} + 16 \Leftrightarrow (x + 4)^2 = \frac{27}{2} \Leftrightarrow x + 4 = \pm\sqrt{\frac{27}{2}} \Leftrightarrow x = -4 \pm \frac{3\sqrt{6}}{2}$.
27. $2x^2 + 7x + 4 = 0 \Leftrightarrow x^2 + \frac{7}{2}x + 2 = 0 \Leftrightarrow x^2 + \frac{7}{2}x = -2 \Leftrightarrow x^2 + \frac{7}{2}x + \frac{49}{16} = -2 + \frac{49}{16} \Leftrightarrow \left(x + \frac{7}{4}\right)^2 = \frac{17}{16} \Leftrightarrow x + \frac{7}{4} = \pm\sqrt{\frac{17}{16}} \Leftrightarrow x = -\frac{7}{4} \pm \frac{\sqrt{17}}{4}$.
28. $4x^2 + 5x - 8 = 0 \Leftrightarrow x^2 + \frac{5}{4}x - 2 = 0 \Leftrightarrow x^2 + \frac{5}{4}x = 2 \Leftrightarrow x^2 + \frac{5}{4}x + \frac{25}{64} = 2 + \frac{25}{64} \Leftrightarrow \left(x + \frac{5}{8}\right)^2 = \frac{153}{64} \Leftrightarrow x + \frac{5}{8} = \pm\sqrt{\frac{153}{64}} \Leftrightarrow x = -\frac{5}{8} \pm \frac{3\sqrt{17}}{8}$.
29. $x^2 - 8x + 12 = 0 \Leftrightarrow (x - 2)(x - 6) = 0 \Leftrightarrow x = 2 \text{ or } x = 6$.
30. $x^2 - 3x - 18 = 0 \Leftrightarrow (x + 3)(x - 6) = 0 \Leftrightarrow x = -3 \text{ or } x = 6$.
31. $x^2 + 8x - 20 = 0 \Leftrightarrow (x + 10)(x - 2) = 0 \Leftrightarrow x = -10 \text{ or } x = 2$.
32. $10x^2 + 9x - 7 = 0 \Leftrightarrow (5x + 7)(2x - 1) = 0 \Leftrightarrow x = -\frac{7}{5} \text{ or } x = \frac{1}{2}$.
33. $2x^2 + x - 3 = 0 \Leftrightarrow (x - 1)(2x + 3) = 0 \Leftrightarrow x - 1 = 0 \text{ or } 2x + 3 = 0$. If $x - 1 = 0$, then $x = 1$; if $2x + 3 = 0$, then $x = -\frac{3}{2}$.
34. $3x^2 + 7x + 4 = 0 \Leftrightarrow (3x + 4)(x + 1) = 0 \Leftrightarrow 3x + 4 = 0 \text{ or } x + 1 = 0$. Thus, $x = -\frac{4}{3} \text{ or } x = -1$.
35. $3x^2 + 6x - 5 = 0 \Leftrightarrow x^2 + 2x - \frac{5}{3} = 0 \Leftrightarrow x^2 + 2x = \frac{5}{3} \Leftrightarrow x^2 + 2x + 1 = \frac{5}{3} + 1 \Leftrightarrow (x + 1)^2 = \frac{8}{3} \Rightarrow x + 1 = \pm\sqrt{\frac{8}{3}} \Leftrightarrow x = -1 \pm \frac{2\sqrt{6}}{3}$.
36. $x^2 - 6x + 1 = 0 \Rightarrow x = \frac{-b \pm \sqrt{b^2 - 4ac}}{2a} = \frac{-(-6) \pm \sqrt{(-6)^2 - 4(1)(1)}}{2(1)} = \frac{6 \pm \sqrt{36 - 4}}{2} = \frac{6 \pm \sqrt{32}}{2} = \frac{6 \pm 4\sqrt{2}}{2} = 3 \pm 2\sqrt{2}$.
37. $x^2 - \frac{4}{3}x + \frac{4}{9} = 0 \Leftrightarrow 9x^2 - 12x + 4 = 0 \Leftrightarrow (3x - 2)^2 = 0 \Leftrightarrow x = \frac{2}{3}$.

$$38. 2x^2 + 3x - \frac{1}{2} = 0 \Leftrightarrow 4x^2 + 6x - 1 = 0 \Leftrightarrow x = \frac{-b \pm \sqrt{b^2 - 4ac}}{2a} = \frac{-6 \pm \sqrt{6^2 - 4(4)(-1)}}{2(4)} = \frac{-6 \pm \sqrt{52}}{8} = \frac{3 \pm \sqrt{13}}{4}.$$

$$39. 4x^2 + 16x - 9 = 0 \Leftrightarrow (2x - 1)(2x + 9) = 0 \Leftrightarrow 2x - 1 = 0 \text{ or } 2x + 9 = 0. \text{ If } 2x - 1 = 0, \text{ then } x = \frac{1}{2}; \text{ if } 2x + 9 = 0, \text{ then } x = -\frac{9}{2}.$$

$$40. 0 = x^2 - 4x + 1 = 0 \Rightarrow x = \frac{-b \pm \sqrt{b^2 - 4ac}}{2a} = \frac{-(-4) \pm \sqrt{(-4)^2 - 4(1)(1)}}{2(1)} = \frac{4 \pm \sqrt{16 - 4}}{2} = \frac{4 \pm \sqrt{12}}{2} = \frac{4 \pm 2\sqrt{3}}{2} = 2 \pm \sqrt{3}.$$

$$41. w^2 = 3(w - 1) \Leftrightarrow w^2 - 3w + 3 = 0 \Rightarrow w = \frac{-(-3) \pm \sqrt{(-3)^2 - 4(1)(3)}}{2(1)} = \frac{3 \pm \sqrt{9 - 12}}{2} = \frac{3 \pm \sqrt{-3}}{2}. \text{ Since the discriminant is less than 0, the equation has no real solution.}$$

$$42. 3 + 5z + z^2 = 0 \Rightarrow z = \frac{-b \pm \sqrt{b^2 - 4ac}}{2a} = \frac{-(5) \pm \sqrt{(5)^2 - 4(1)(3)}}{2(1)} = \frac{-5 \pm \sqrt{25 - 12}}{2} = \frac{-5 \pm \sqrt{13}}{2}.$$

$$43. 10y^2 - 16y + 5 = 0 \Rightarrow x = \frac{-b \pm \sqrt{b^2 - 4ac}}{2a} = \frac{-(-16) \pm \sqrt{(-16)^2 - 4(10)(5)}}{2(10)} = \frac{16 \pm \sqrt{256 - 200}}{20} = \frac{16 \pm \sqrt{56}}{20} = \frac{8 \pm \sqrt{14}}{10}.$$

$$44. 25x^2 + 70x + 49 = 0 \Leftrightarrow (5x + 7)^2 = 0 \Leftrightarrow 5x + 7 = 0 \Leftrightarrow 5x = -7 \Leftrightarrow x = -\frac{7}{5}.$$

$$45. 3x^2 + 2x + 2 = 0 \Rightarrow x = \frac{-b \pm \sqrt{b^2 - 4ac}}{2a} = \frac{-(2) \pm \sqrt{(2)^2 - 4(3)(2)}}{2(3)} = \frac{-2 \pm \sqrt{4 - 24}}{6} = \frac{-2 \pm \sqrt{-20}}{6}. \text{ Since the discriminant is less than 0, the equation has no real solution.}$$

$$46. 5x^2 - 7x + 5 = 0 \Rightarrow x = \frac{-b \pm \sqrt{b^2 - 4ac}}{2a} = \frac{-(-7) \pm \sqrt{(-7)^2 - 4(5)(5)}}{2(5)} = \frac{7 \pm \sqrt{49 - 100}}{10} = \frac{7 \pm \sqrt{-51}}{10}.$$

Since the discriminant is less than 0, the equation has no real solution.

$$47. x^2 - 0.011x - 0.064 = 0 \Rightarrow x = \frac{-(-0.011) \pm \sqrt{(-0.011)^2 - 4(1)(-0.064)}}{2(1)} = \frac{0.011 \pm \sqrt{0.000121 + 0.256}}{2} \approx \frac{0.011 \pm 0.506}{2}.$$

$$\text{Thus, } x \approx \frac{0.011 + 0.506}{2} = 0.259 \text{ or } x \approx \frac{0.011 - 0.506}{2} = -0.248.$$

$$48. x^2 - 2.450x + 1.500 = 0 \Rightarrow x = \frac{-(-2.450) \pm \sqrt{(-2.450)^2 - 4(1)(1.500)}}{2(1)} = \frac{2.450 \pm \sqrt{6.0025 - 6}}{2} = \frac{2.450 \pm \sqrt{0.0025}}{2} = \frac{2.450 \pm 0.050}{2}. \text{ Thus,}$$

$$x = \frac{2.450 + 0.050}{2} = 1.250 \text{ or } x = \frac{2.450 - 0.050}{2} = 1.200.$$

$$49. x^2 - 2.450x + 1.501 = 0 \Rightarrow x = \frac{-(-2.450) \pm \sqrt{(-2.450)^2 - 4(1)(1.501)}}{2(1)} = \frac{2.450 \pm \sqrt{6.0025 - 6.004}}{2} = \frac{2.450 \pm \sqrt{-0.0015}}{2}.$$

Thus, there is no real solution.

$$50. x^2 - 1.800x + 0.810 = 0 \Rightarrow x = \frac{-(-1.800) \pm \sqrt{(-1.800)^2 - 4(1)(0.810)}}{2(1)} = \frac{1.800 \pm \sqrt{3.24 - 3.24}}{2} = \frac{1.800 \pm \sqrt{0}}{2} = 0.900. \text{ Thus the only solution is } x = 0.900.$$

51. $h = \frac{1}{2}gt^2 + v_0t \Leftrightarrow \frac{1}{2}gt^2 + v_0t - h = 0$. Using the Quadratic Formula,

$$t = \frac{-(v_0) \pm \sqrt{(v_0)^2 - 4\left(\frac{1}{2}g\right)(-h)}}{2\left(\frac{1}{2}g\right)} = \frac{-v_0 \pm \sqrt{v_0^2 + 2gh}}{g}.$$

52. $S = \frac{n(n+1)}{2} \Leftrightarrow 2S = n^2 + n \Leftrightarrow n^2 + n - 2S = 0$. Using the Quadratic Formula,

$$n = \frac{-1 \pm \sqrt{(1)^2 - 4(1)(-2S)}}{2(1)} = \frac{-1 \pm \sqrt{1 + 8S}}{2}.$$

53. $A = 2x^2 + 4xh \Leftrightarrow 2x^2 + 4xh - A = 0$. Using the Quadratic Formula,

$$\begin{aligned} x &= \frac{-(4h) \pm \sqrt{(4h)^2 - 4(2)(-A)}}{2(2)} = \frac{-4h \pm \sqrt{16h^2 + 8A}}{4} = \frac{-4h \pm \sqrt{4(4h^2 + 2A)}}{4} = \frac{-4h \pm 2\sqrt{4h^2 + 2A}}{4} \\ &= \frac{2(-2h \pm \sqrt{4h^2 + 2A})}{4} = \frac{-2h \pm \sqrt{4h^2 + 2A}}{2} \end{aligned}$$

54. $A = 2\pi r^2 + 2\pi rh \Leftrightarrow 2\pi r^2 + 2\pi rh - A = 0$. Using the Quadratic Formula,

$$r = \frac{-(2\pi h) \pm \sqrt{(2\pi h)^2 - 4(2\pi)(-A)}}{2(2\pi)} = \frac{-2\pi h \pm \sqrt{4\pi^2 h^2 + 8\pi A}}{4\pi} = \frac{-\pi h \pm \sqrt{\pi^2 h^2 + 2\pi A}}{2\pi}.$$

55. $\frac{1}{s+a} + \frac{1}{s+b} = \frac{1}{c} \Leftrightarrow c(s+b) + c(s+a) = (s+a)(s+b) \Leftrightarrow cs + bc + cs + ac = s^2 + as + bs + ab \Leftrightarrow$
 $s^2 + (a+b-2c)s + (ab-ac-bc) = 0$. Using the Quadratic Formula,

$$\begin{aligned} s &= \frac{-(a+b-2c) \pm \sqrt{(a+b-2c)^2 - 4(1)(ab-ac-bc)}}{2(1)} \\ &= \frac{-(a+b-2c) \pm \sqrt{a^2 + b^2 + 4c^2 + 2ab - 4ac - 4bc - 4ab + 4ac + 4bc}}{2} \\ &= \frac{-(a+b-2c) \pm \sqrt{a^2 + b^2 + 4c^2 - 2ab}}{2} \end{aligned}$$

56. $\frac{1}{r} + \frac{2}{1-r} = \frac{4}{r^2} \Leftrightarrow r^2(1-r)\left(\frac{1}{r} + \frac{2}{1-r}\right) = r^2(1-r)\left(\frac{4}{r^2}\right) \Leftrightarrow r(1-r) + 2r^2 = 4(1-r) \Leftrightarrow r - r^2 + 2r^2 = 4 - 4r$

$$\Leftrightarrow r^2 + 5r - 4 = 0. \text{ Using the Quadratic Formula, } r = \frac{-(5) \pm \sqrt{(5)^2 - 4(1)(-4)}}{2(1)} = \frac{-5 \pm \sqrt{25 + 16}}{2} = \frac{-5 \pm \sqrt{41}}{2}.$$

57. $D = b^2 - 4ac = (-6)^2 - 4(1)(1) = 32$. Since D is positive, this equation has two real solutions.

58. $x^2 = 6x - 9 \Leftrightarrow x^2 - 6x + 9$, so $D = b^2 - 4ac = (-6)^2 - 4(1)(9) = 36 - 36 = 0$. Since $D = 0$, this equation has one real solution.

59. $D = b^2 - 4ac = (2.20)^2 - 4(1)(1.21) = 4.84 - 4.84 = 0$. Since $D = 0$, this equation has one real solution.

60. $D = b^2 - 4ac = (2.21)^2 - 4(1)(1.21) = 4.8841 - 4.84 = 0.0441$. Since $D \neq 0$, this equation has two real solutions.

61. $D = b^2 - 4ac = (5)^2 - 4(4)\left(\frac{13}{8}\right) = 25 - 26 = -1$. Since D is negative, this equation has no real solution.

62. $D = b^2 - 4ac = (r)^2 - 4(1)(-s) = r^2 + 4s$. Since D is positive, this equation has two real solutions.

63. $a^2x^2 + 2ax + 1 = 0 \Leftrightarrow (ax + 1)^2 = 0 \Leftrightarrow ax + 1 = 0$. So $ax + 1 = 0$ then $ax = -1 \Leftrightarrow x = -\frac{1}{a}$.

64. $ax^2 - (2a+1)x + (a+1) = 0 \Leftrightarrow [ax - (a+1)](x-1) = 0 \Leftrightarrow ax - (a+1) = 0$ or $x-1 = 0$. If $ax - (a+1) = 0$, then $x = \frac{a+1}{a}$; if $x-1 = 0$, then $x = 1$.

65. We want to find the values of k that make the discriminant 0. Thus $k^2 - 4(4)(25) = 0 \Leftrightarrow k^2 = 400 \Leftrightarrow k = \pm 20$.
66. We want to find the values of k that make the discriminant 0. Thus $D = 36^2 - 4(k)(k) = 0 \Leftrightarrow 4k^2 = 36^2 \Rightarrow 2k = \pm 36 \Leftrightarrow k = \pm 18$.
67. Let n be one number. Then the other number must be $55 - n$, since $n + (55 - n) = 55$. Because the product is 684, we have $(n)(55 - n) = 684 \Leftrightarrow 55n - n^2 = 684 \Leftrightarrow n^2 - 55n + 684 = 0 \Rightarrow$

$$n = \frac{-(-55) \pm \sqrt{(-55)^2 - 4(1)(684)}}{2(1)} = \frac{55 \pm \sqrt{3025 - 2736}}{2} = \frac{55 \pm \sqrt{289}}{2} = \frac{55 \pm 17}{2}$$
. So $n = \frac{55+17}{2} = \frac{72}{2} = 36$ or
 $n = \frac{55-17}{2} = \frac{38}{2} = 19$. In either case, the two numbers are 19 and 36.
68. Let n be one even number. Then the next even number is $n + 2$. Thus we get the equation $n^2 + (n + 2)^2 = 1252 \Leftrightarrow$
 $n^2 + n^2 + 4n + 4 = 1252 \Leftrightarrow 0 = 2n^2 + 4n - 1248 = 2(n^2 + 2n - 624) = 2(n - 24)(n + 26)$. So $n = 24$ or $n = -26$.
 Thus the consecutive even integers are 24 and 26 or -26 and -24 .
69. Let w be the width of the garden in feet. Then the length is $w + 10$. Thus $875 = w(w + 10) \Leftrightarrow w^2 + 10w - 875 = 0 \Leftrightarrow$
 $(w + 35)(w - 25) = 0$. So $w + 35 = 0$ in which case $w = -35$, which is not possible, or $w - 25 = 0$ and so $w = 25$.
 Thus the width is 25 feet and the length is 35 feet.
70. Let w be the width of the bedroom. Then its length is $w + 7$. Since area is length times width, we have
 $228 = (w + 7)w = w^2 + 7w \Leftrightarrow w^2 + 7w - 228 = 0 \Leftrightarrow (w + 19)(w - 12) = 0 \Leftrightarrow w + 19 = 0$ or $w - 12 = 0$. Thus
 $w = -19$ or $w = 12$. Since the width must be positive, the width is 12 feet.
71. Let w be the width of the garden in feet. We use the perimeter to express the length l of the garden in terms of width. Since the perimeter is twice the width plus twice the length, we have $200 = 2w + 2l \Leftrightarrow 2l = 200 - 2w \Leftrightarrow l = 100 - w$. Using the formula for area, we have $2400 = w(100 - w) = 100w - w^2 \Leftrightarrow w^2 - 100w + 2400 = 0 \Leftrightarrow (w - 40)(w - 60) = 0$. So $w - 40 = 0 \Leftrightarrow w = 40$, or $w - 60 = 0 \Leftrightarrow w = 60$. If $w = 40$, then $l = 100 - 40 = 60$. And if $w = 60$, then $l = 100 - 60 = 40$. So the length is 60 feet and the width is 40 feet.

72. First we write a formula for the area of the figure in terms of x . Region A has dimensions 14 in. and x in. and region B has dimensions $(13 + x)$ in. and x in. So the area of the figure is $(14 \cdot x) + [(13 + x)x] = 14x + 13x + x^2 = x^2 + 27x$. We are given that this is equal to 160 in^2 , so $160 = x^2 + 27x \Leftrightarrow x^2 + 27x - 160 = 0 \Leftrightarrow (x + 32)(x - 5) \Leftrightarrow x = -32$ or $x = 5$. x must be positive, so $x = 5$ in.

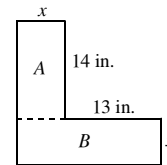

73. The shaded area is the sum of the area of a rectangle and the area of a triangle. So $A = y(1) + \frac{1}{2}(y)(y) = \frac{1}{2}y^2 + y$. We are given that the area is 1200 cm^2 , so $1200 = \frac{1}{2}y^2 + y \Leftrightarrow y^2 + 2y - 2400 = 0 \Leftrightarrow (y + 50)(y - 48) = 0$. y is positive, so $y = 48 \text{ cm}$.
74. Setting $P = 1250$ and solving for x , we have $1250 = \frac{1}{10}x(300 - x) = 30x - \frac{1}{10}x^2 \Leftrightarrow \frac{1}{10}x^2 - 30x + 1250 = 0$.

$$\text{Using the Quadratic Formula, } x = \frac{-(-30) \pm \sqrt{(-30)^2 - 4\left(\frac{1}{10}\right)(1250)}}{2\left(\frac{1}{10}\right)} = \frac{30 \pm \sqrt{900 - 500}}{0.2} = \frac{30 \pm 20}{0.2}.$$
 Thus

$$x = \frac{30 - 20}{0.2} = 50 \text{ or } x = \frac{30 + 20}{0.2} = 250. \text{ Since he must have } 0 \leq x \leq 200, \text{ he should make 50 ovens per week.}$$

75. Let x be the length of one side of the cardboard, so we start with a piece of cardboard x by x . When 4 inches are removed from each side, the base of the box is $x - 8$ by $x - 8$. Since the volume is 100 in^3 , we get $4(x - 8)^2 = 100 \Leftrightarrow x^2 - 16x + 64 = 25 \Leftrightarrow x^2 - 16x + 39 = 0 \Leftrightarrow (x - 3)(x - 13) = 0$. So $x = 3$ or $x = 13$. But $x = 3$ is not possible, since then the length of the base would be $3 - 8 = -5$, and all lengths must be positive. Thus $x = 13$, and the piece of cardboard is 13 inches by 13 inches.

76. Let r be the radius of the can. Now using the formula $V = \pi r^2 h$ with $V = 40\pi \text{ cm}^3$ and $h = 10$, we solve for r . Thus $40\pi = \pi r^2 (10) \Leftrightarrow 4 = r^2 \Rightarrow r = \pm 2$. Since r represents radius, $r > 0$. Thus $r = 2$, and the diameter is 4 cm.
77. Let w be the width of the lot in feet. Then the length is $w + 6$. Using the Pythagorean Theorem, we have $w^2 + (w + 6)^2 = (174)^2 \Leftrightarrow w^2 + w^2 + 12w + 36 = 30,276 \Leftrightarrow 2w^2 + 12w - 30,240 = 0 \Leftrightarrow w^2 + 6w - 15,120 = 0 \Leftrightarrow (w + 126)(w - 120) = 0$. So either $w + 126 = 0$ in which case $w = -126$, which is not possible, or $w - 120 = 0$ in which case $w = 120$. Thus the width is 120 feet and the length is 126 feet.
78. Let h be the height of the flagpole, in feet. Then the length of each guy wire is $h + 5$. Since the distance between the points where the wires are fixed to the ground is equal to one guy wire, the triangle is equilateral, and the flagpole is the perpendicular bisector of the base. Thus from the Pythagorean Theorem, we get $\left[\frac{1}{2}(h + 5)\right]^2 + h^2 = (h + 5)^2 \Leftrightarrow h^2 + 10h + 25 + 4h^2 = 4h^2 + 40h + 100 \Leftrightarrow h^2 - 30h - 75 = 0 \Rightarrow$
 $h = \frac{-(-30) \pm \sqrt{(-30)^2 - 4(1)(-75)}}{2(1)} = \frac{30 \pm \sqrt{900 + 300}}{2} = \frac{30 \pm \sqrt{1200}}{2} = \frac{30 \pm 20\sqrt{3}}{2}$. Since $h = \frac{30 - 20\sqrt{3}}{2} < 0$, we reject it. Thus the height is $h = \frac{30 + 20\sqrt{3}}{2} = 15 + 10\sqrt{3} \approx 32.32 \text{ ft} \approx 32 \text{ ft } 4 \text{ in}$.
79. Let x be the rate, in mi/h, at which the salesman drove between Ajax and Barrington.

Direction	Distance	Rate	Time
Ajax \rightarrow Barrington	120	x	$\frac{120}{x}$
Barrington \rightarrow Collins	150	$x + 10$	$\frac{150}{x + 10}$

We have used the equation $\text{time} = \frac{\text{distance}}{\text{rate}}$ to fill in the "Time" column of the table. Since the second part of the trip took 6 minutes (or $\frac{1}{10}$ hour) more than the first, we can use the time column to get the equation $\frac{120}{x} + \frac{1}{10} = \frac{150}{x + 10} \Rightarrow 120(10)(x + 10) + x(x + 10) = 150(10x) \Leftrightarrow 1200x + 12,000 + x^2 + 10x = 1500x \Leftrightarrow x^2 - 290x + 12,000 = 0 \Leftrightarrow$
 $x = \frac{-(-290) \pm \sqrt{(-290)^2 - 4(1)(12,000)}}{2} = \frac{290 \pm \sqrt{84,100 - 48,000}}{2} = \frac{290 \pm \sqrt{36,100}}{2} = \frac{290 \pm 190}{2} = 145 \pm 95$. Hence, the salesman drove either 50 mi/h or 240 mi/h between Ajax and Barrington. (The first choice seems more likely!)

80. Let x be the rate, in mi/h, at which Kiran drove from Tortula to Cactus.

Direction	Distance	Rate	Time
Tortula \rightarrow Cactus	250	x	$\frac{250}{x}$
Cactus \rightarrow Dry Junction	360	$x + 10$	$\frac{360}{x + 10}$

We have used $\text{time} = \frac{\text{distance}}{\text{rate}}$ to fill in the time column of the table. We are given that the sum of the times is 11 hours. Thus we get the equation $\frac{250}{x} + \frac{360}{x + 10} = 11 \Leftrightarrow 250(x + 10) + 360x = 11x(x + 10) \Leftrightarrow 250x + 2500 + 360x = 11x^2 + 110x \Leftrightarrow 11x^2 - 500x - 2500 = 0 \Rightarrow$
 $x = \frac{-(-500) \pm \sqrt{(-500)^2 - 4(11)(-2500)}}{2(11)} = \frac{500 \pm \sqrt{250,000 + 110,000}}{22} = \frac{500 \pm \sqrt{360,000}}{22} = \frac{500 \pm 600}{22}$. Hence, Kiran drove either -4.54 mi/h (impossible) or 50 mi/h between Tortula and Cactus.

81. Let r be the rowing rate in km/h of the crew in still water. Then their rate upstream was $r - 3$ km/h, and their rate downstream was $r + 3$ km/h.

Direction	Distance	Rate	Time
Upstream	6	$r - 3$	$\frac{6}{r - 3}$
Downstream	6	$r + 3$	$\frac{6}{r + 3}$

- Since the time to row upstream plus the time to row downstream was 2 hours 40 minutes = $\frac{8}{3}$ hour, we get the equation $\frac{6}{r - 3} + \frac{6}{r + 3} = \frac{8}{3} \Leftrightarrow 6(3)(r + 3) + 6(3)(r - 3) = 8(r - 3)(r + 3) \Leftrightarrow 18r + 54 + 18r - 54 = 8r^2 - 72 \Leftrightarrow 0 = 8r^2 - 36r - 72 = 4(2r^2 - 9r - 18) = 4(2r + 3)(r - 6) \Leftrightarrow 2r + 3 = 0$ or $r - 6 = 0$. If $2r + 3 = 0$, then $r = -\frac{3}{2}$, which is impossible because the rowing rate is positive. If $r - 6 = 0$, then $r = 6$. So the rate of the rowing crew in still water is 6 km/h.
82. Let r be the speed of the southbound boat. Then $r + 3$ is the speed of the eastbound boat. In two hours the southbound boat has traveled $2r$ miles and the eastbound boat has traveled $2(r + 3) = 2r + 6$ miles. Since they are traveling in directions with a 90° apart, we can use the Pythagorean Theorem to get $(2r)^2 + (2r + 6)^2 = 30^2 \Leftrightarrow 4r^2 + 4r^2 + 24r + 36 = 900 \Leftrightarrow 8r^2 + 24r - 864 = 0 \Leftrightarrow 8(r^2 + 3r - 108) = 0 \Leftrightarrow 8(r + 12)(r - 9) = 0$. So $r = -12$ or $r = 9$. Since speed is positive, the speed of the southbound boat is 9 mi/h.
83. Using $h_0 = 288$, we solve $0 = -16t^2 + 288$, for $t \geq 0$. So $0 = -16t^2 + 288 \Leftrightarrow 16t^2 = 288 \Leftrightarrow t^2 = 18 \Rightarrow t = \pm\sqrt{18} = \pm 3\sqrt{2}$. Thus it takes $3\sqrt{2} \approx 4.24$ seconds for the ball to hit the ground.
84. (a) Using $h_0 = 96$, half the distance is 48, so we solve the equation $48 = -16t^2 + 96 \Leftrightarrow -48 = -16t^2 \Leftrightarrow 3 = t^2 \Rightarrow t = \pm\sqrt{3}$. Since $t \geq 0$, it takes $\sqrt{3} \approx 1.732$ s.
- (b) The ball hits the ground when $h = 0$, so we solve the equation $0 = -16t^2 + 96 \Leftrightarrow 16t^2 = 96 \Leftrightarrow t^2 = 6 \Rightarrow t = \pm\sqrt{6}$. Since $t \geq 0$, it takes $\sqrt{6} \approx 2.449$ s.
85. We are given $v_o = 40$ ft/s.
- (a) Setting $h = 24$, we have $24 = -16t^2 + 40t \Leftrightarrow 16t^2 - 40t + 24 = 0 \Leftrightarrow 8(2t^2 - 5t + 3) = 0 \Leftrightarrow 8(2t - 3)(t - 1) = 0 \Leftrightarrow t = 1$ or $t = 1\frac{1}{2}$. Therefore, the ball reaches 24 feet in 1 second (ascending) and again after $1\frac{1}{2}$ seconds (descending).
- (b) Setting $h = 48$, we have $48 = -16t^2 + 40t \Leftrightarrow 16t^2 - 40t + 48 = 0 \Leftrightarrow 2t^2 - 5t + 6 = 0 \Leftrightarrow t = \frac{5 \pm \sqrt{25 - 48}}{4} = \frac{5 \pm \sqrt{-23}}{4}$. However, since the discriminant $D < 0$, there is no real solution, and hence the ball never reaches a height of 48 feet.
- (c) The greatest height h is reached only once. So $h = -16t^2 + 40t \Leftrightarrow 16t^2 - 40t + h = 0$ has only one solution. Thus $D = (-40)^2 - 4(16)(h) = 0 \Leftrightarrow 1600 - 64h = 0 \Leftrightarrow h = 25$. So the greatest height reached by the ball is 25 feet.
- (d) Setting $h = 25$, we have $25 = -16t^2 + 40t \Leftrightarrow 16t^2 - 40t + 25 = 0 \Leftrightarrow (4t - 5)^2 = 0 \Leftrightarrow t = 1\frac{1}{4}$. Thus the ball reaches the highest point of its path after $1\frac{1}{4}$ seconds.
- (e) Setting $h = 0$ (ground level), we have $0 = -16t^2 + 40t \Leftrightarrow 2t^2 - 5t = 0 \Leftrightarrow t(2t - 5) = 0 \Leftrightarrow t = 0$ (start) or $t = 2\frac{1}{2}$. So the ball hits the ground in $2\frac{1}{2}$ s.
86. If the maximum height is 100 feet, then the discriminant of the equation, $16t^2 - v_o t + 100 = 0$, must equal zero. So $0 = b^2 - 4ac = (-v_o)^2 - 4(16)(100) \Leftrightarrow v_o^2 = 6400 \Rightarrow v_o = \pm 80$. Since $v_o = -80$ does not make sense, we must have $v_o = 80$ ft/s.

- 87. (a)** The fish population on January 1, 2002 corresponds to $t = 0$, so $F = 1000(30 + 17(0) - (0)^2) = 30,000$. To find when the population will again reach this value, we set $F = 30,000$, giving
- $$30000 = 1000(30 + 17t - t^2) = 30000 + 17000t - 1000t^2 \Leftrightarrow 0 = 17000t - 1000t^2 = 1000t(17 - t) \Leftrightarrow t = 0 \text{ or } t = 17.$$
- Thus the fish population will again be the same 17 years later, that is, on January 1, 2019.
- (b)** Setting $F = 0$, we have $0 = 1000(30 + 17t - t^2) \Leftrightarrow t^2 - 17t - 30 = 0 \Leftrightarrow$
- $$t = \frac{17 \pm \sqrt{289 + 120}}{-2} = \frac{17 \pm \sqrt{409}}{-2} = \frac{17 \pm 20.22}{-2}.$$
- Thus $t \approx -1.612$ or $t \approx 18.612$. Since $t < 0$ is inadmissible, it follows that the fish in the lake will have died out 18.612 years after January 1, 2002, that is on August 12, 2020.
- 88.** Let y be the circumference of the circle, so $360 - y$ is the perimeter of the square. Use the circumference to find the radius, r , in terms of y : $y = 2\pi r \Rightarrow r = y/(2\pi)$. Thus the area of the circle is $\pi [y/(2\pi)]^2 = y^2/(4\pi)$. Now if the perimeter of the square is $360 - y$, the length of each side is $\frac{1}{4}(360 - y)$, and the area of the square is $[\frac{1}{4}(360 - y)]^2$. Setting these areas equal, we obtain $y^2/(4\pi) = [\frac{1}{4}(360 - y)]^2 \Leftrightarrow y/(2\sqrt{\pi}) = \frac{1}{4}(360 - y) \Leftrightarrow 2y = 360\sqrt{\pi} - \sqrt{\pi}y \Leftrightarrow (2 + \sqrt{\pi})y = 360\sqrt{\pi}$. Therefore, $y = 360\sqrt{\pi}/(2 + \sqrt{\pi}) \approx 169.1$. Thus one wire is 169.1 in. long and the other is 190.9 in. long.
- 89.** Let w be the uniform width of the lawn. With w cut off each end, the area of the factory is $(240 - 2w)(180 - 2w)$. Since the lawn and the factory are equal in size this area, is $\frac{1}{2} \cdot 240 \cdot 180$. So $21,600 = 43,200 - 480w - 360w + 4w^2 \Leftrightarrow 0 = 4w^2 - 840w + 21,600 = 4(w^2 - 210w + 5400) = 4(w - 30)(w - 180) \Rightarrow w = 30$ or $w = 180$. Since 180 ft is too wide, the width of the lawn is 30 ft, and the factory is 120 ft by 180 ft.
- 90.** Let h be the height the ladder reaches (in feet). Using the Pythagorean Theorem we have $(7\frac{1}{2})^2 + h^2 = (19\frac{1}{2})^2 \Leftrightarrow (\frac{15}{2})^2 + h^2 = (\frac{39}{2})^2 \Leftrightarrow h^2 = (\frac{39}{2})^2 - (\frac{15}{2})^2 = \frac{1521}{4} - \frac{225}{4} = \frac{1296}{4} = 324$. So $h = \sqrt{324} = 18$ feet.
- 91.** Let t be the time, in hours it takes Irene to wash all the windows. Then it takes Henry $t + \frac{3}{2}$ hours to wash all the windows, and the sum of the fraction of the job per hour they can do individually equals the fraction of the job they can do together. Since 1 hour 48 minutes $= 1 + \frac{48}{60} = 1 + \frac{4}{5} = \frac{9}{5}$, we have $\frac{1}{t} + \frac{1}{t + \frac{3}{2}} = \frac{1}{\frac{9}{5}} \Leftrightarrow \frac{1}{t} + \frac{2}{2t + 3} = \frac{5}{9} \Rightarrow 9(2t + 3) + 2(9t) = 5t(2t + 3) \Leftrightarrow 18t + 27 + 18t = 10t^2 + 15t \Leftrightarrow 10t^2 - 21t - 27 = 0$
- $$\Leftrightarrow t = \frac{-(-21) \pm \sqrt{(-21)^2 - 4(10)(-27)}}{2(10)} = \frac{21 \pm \sqrt{441 + 1080}}{20} = \frac{21 \pm 39}{20}.$$
- So $t = \frac{21 - 39}{20} = -\frac{9}{10}$ or $t = \frac{21 + 39}{20} = 3$. Since $t < 0$ is impossible, all the windows are washed by Irene alone in 3 hours and by Henry alone in $3 + \frac{3}{2} = 4\frac{1}{2}$ hours.
- 92.** Let t be the time, in hours, it takes Kay to deliver all the flyers alone. Then it takes Lynn $t + 1$ hours to deliver all the flyers alone, and it takes the group $0.4t$ hours to do it together. Thus $\frac{1}{4} + \frac{1}{t} + \frac{1}{t + 1} = \frac{1}{0.4t} \Leftrightarrow \frac{1}{4}(0.4t) + \frac{1}{t}(0.4t) + \frac{1}{t + 1}(0.4t) = 1 \Leftrightarrow t + 4 + \frac{4t}{t + 1} = 10 \Leftrightarrow t(t + 1) + 4(t + 1) + 4t = 10(t + 1) \Leftrightarrow t^2 + t + 4t + 4 + 4t = 10t + 10 \Leftrightarrow t^2 - t - 6 = 0 \Leftrightarrow (t - 3)(t + 2) = 0$. So $t = 3$ or $t = -2$. Since $t = -2$ is impossible, it takes Kay 3 hours to deliver all the flyers alone.

93. Let x be the distance from the center of the earth to the dead spot (in thousands of miles). Now setting

$$F = 0, \text{ we have } 0 = -\frac{K}{x^2} + \frac{0.012K}{(239-x)^2} \Leftrightarrow \frac{K}{x^2} = \frac{0.012K}{(239-x)^2} \Leftrightarrow K(239-x)^2 = 0.012Kx^2 \Leftrightarrow$$

$$57121 - 478x + x^2 = 0.012x^2 \Leftrightarrow 0.988x^2 - 478x + 57121 = 0. \text{ Using the Quadratic Formula, we obtain}$$

$$x = \frac{-(-478) \pm \sqrt{(-478)^2 - 4(0.988)(57121)}}{2(0.988)} = \frac{478 \pm \sqrt{228484 - 225742.192}}{1.976} = \frac{478 \pm \sqrt{2741.808}}{1.976} \approx \frac{478 \pm 52.362}{1.976} \approx 241.903 \pm 26.499.$$

So either $x \approx 241.903 + 26.499 \approx 268$ or $x \approx 241.903 - 26.499 \approx 215$. Since 268 is greater than the distance from the earth to the moon, we reject it; thus $x \approx 215,000$ miles.

94. If we have $x^2 - 9x + 20 = (x - 4)(x - 5) = 0$, then $x = 4$ or $x = 5$, so the roots are 4 and 5. The product is $4 \cdot 5 = 20$, and the sum is $4 + 5 = 9$. If we have $x^2 - 2x - 8 = (x - 4)(x + 2) = 0$, then $x = 4$ or $x = -2$, so the roots are 4 and -2 . The product is $4 \cdot (-2) = -8$, and the sum is $4 + (-2) = 2$. Lastly, if we have $x^2 + 4x + 2 = 0$, then using the Quadratic Formula,

$$\text{we have } x = \frac{-4 \pm \sqrt{4^2 - 4(1)(2)}}{2(1)} = \frac{-4 \pm \sqrt{8}}{2} = \frac{-4 \pm 2\sqrt{2}}{2} = -2 \pm \sqrt{2}. \text{ The roots are } -2 - \sqrt{2} \text{ and } -2 + \sqrt{2}. \text{ The}$$

product is $(-2 - \sqrt{2}) \cdot (-2 + \sqrt{2}) = 4 - 2 = 2$, and the sum is $(-2 - \sqrt{2}) + (-2 + \sqrt{2}) = -4$. In general, if $x = r_1$ and $x = r_2$ are roots, then $x^2 + bx + c = (x - r_1)(x - r_2) = x^2 - r_1x - r_2x + r_1r_2 = x^2 - (r_1 + r_2)x + r_1r_2$. Equating the coefficients, we get $c = r_1r_2$ and $b = -(r_1 + r_2)$.

95. Let x equal the original length of the reed in cubits. Then $x - 1$ is the piece that fits 60 times along the length of the field, that is, the length is $60(x - 1)$. The width is $30x$. Then converting cubits to ninda, we have

$$375 = 60(x - 1) \cdot 30x \cdot \frac{1}{12^2} = \frac{25}{2}x(x - 1) \Leftrightarrow 30 = x^2 - x \Leftrightarrow x^2 - x - 30 = 0 \Leftrightarrow (x - 6)(x + 5) = 0. \text{ So } x = 6 \text{ or } x = -5. \text{ Since } x \text{ must be positive, the original length of the reed is 6 cubits.}$$

1.5 COMPLEX NUMBERS

- The imaginary number i has the property that $i^2 = -1$.
- For the complex number $3 + 4i$ the real part is 3 and the imaginary part is 4.
- (a) The complex conjugate of $3 + 4i$ is $\overline{3 + 4i} = 3 - 4i$.
(b) $(3 + 4i)(\overline{3 + 4i}) = 3^2 + 4^2 = 25$
- If $3 + 4i$ is a solution of a quadratic equation with real coefficients, then $\overline{3 + 4i} = 3 - 4i$ is also a solution of the equation.
- Yes, every real number a is a complex number of the form $a + 0i$.
- Yes. For any complex number z , $z + \bar{z} = (a + bi) + (\overline{a + bi}) = a + bi + a - bi = 2a$, which is a real number.
- $5 - 7i$: real part 5, imaginary part -7 .
8. $-6 + 4i$: real part -6 , imaginary part 4.
- $\frac{-2 - 5i}{3} = -\frac{2}{3} - \frac{5}{3}i$: real part $-\frac{2}{3}$, imaginary part $-\frac{5}{3}$.
10. $\frac{4 + 7i}{2} = 2 + \frac{7}{2}i$: real part 2, imaginary part $\frac{7}{2}$.
- 3: real part 3, imaginary part 0.
12. $-\frac{1}{2}$: real part $-\frac{1}{2}$, imaginary part 0.
- $-\frac{2}{3}i$: real part 0, imaginary part $-\frac{2}{3}$.
14. $i\sqrt{3}$: real part 0, imaginary part $\sqrt{3}$.
- $\sqrt{3} + \sqrt{-4} = \sqrt{3} + 2i$: real part $\sqrt{3}$, imaginary part 2.
16. $2 - \sqrt{-5} = 2 - i\sqrt{5}$: real part 2, imaginary part $-\sqrt{5}$.
- $(3 + 2i) + 5i = 3 + (2 + 5)i = 3 + 7i$
18. $3i - (2 - 3i) = -2 + [3 - (-3)]i = -2 + 6i$
- $(5 - 3i) + (-4 - 7i) = (5 - 4) + (-3 - 7)i = 1 - 10i$
19. $(-3 + 4i) - (2 - 5i) = (-3 - 2) + [4 - (-5)]i = -5 + 9i$
- $(-6 + 6i) + (9 - i) = (-6 + 9) + (6 - 1)i = 3 + 5i$
22. $(3 - 2i) + (-5 - \frac{1}{3}i) = (3 - 5) + (-2 - \frac{1}{3})i = -2 - \frac{7}{3}i$
- $(7 - \frac{1}{2}i) - (5 + \frac{3}{2}i) = (7 - 5) + (-\frac{1}{2} - \frac{3}{2})i = 2 - 2i$

24. $(-4 + i) - (2 - 5i) = -4 + i - 2 + 5i = (-4 - 2) + (1 + 5)i = -6 + 6i$
25. $(-12 + 8i) - (7 + 4i) = -12 + 8i - 7 - 4i = (-12 - 7) + (8 - 4)i = -19 + 4i$
26. $6i - (4 - i) = 6i - 4 + i = (-4) + (6 + 1)i = -4 + 7i$
27. $4(-1 + 2i) = -4 + 8i$
28. $-2(3 - 4i) = -6 + 8i$
29. $(7 - i)(4 + 2i) = 28 + 14i - 4i - 2i^2 = (28 + 2) + (14 - 4)i = 30 + 10i$
30. $(5 - 3i)(1 + i) = 5 + 5i - 3i - 3i^2 = (5 + 3) + (5 - 3)i = 8 + 2i$
31. $(6 + 5i)(2 - 3i) = 12 - 18i + 10i - 15i^2 = (12 + 15) + (-18 + 10)i = 27 - 8i$
32. $(-2 + i)(3 - 7i) = -6 + 14i + 3i - 7i^2 = (-6 + 7) + (14 + 3)i = 1 + 17i$
33. $(2 + 5i)(2 - 5i) = 2^2 - (5i)^2 = 4 - 25(-1) = 29$
34. $(3 - 7i)(3 + 7i) = 3^2 - (7i)^2 = 58$
35. $(2 + 5i)^2 = 2^2 + (5i)^2 + 2(2)(5i) = 4 - 25 + 20i = -21 + 20i$
36. $(3 - 7i)^2 = 3^2 + (7i)^2 - 2(3)(7i) = -40 - 42i$
37. $\frac{1}{i} = \frac{1}{i} \cdot \frac{i}{i} = \frac{i}{i^2} = \frac{i}{-1} = -i$
38. $\frac{1}{1+i} = \frac{1}{1+i} \cdot \frac{1-i}{1-i} = \frac{1-i}{1-i^2} = \frac{1-i}{1+1} = \frac{1-i}{2} = \frac{1}{2} - \frac{1}{2}i$
39. $\frac{2-3i}{1-2i} = \frac{2-3i}{1-2i} \cdot \frac{1+2i}{1+2i} = \frac{2+4i-3i-6i^2}{1-4i^2} = \frac{(2+6) + (4-3)i}{1+4} = \frac{8+i}{5}$ or $\frac{8}{5} + \frac{1}{5}i$
40. $\frac{5-i}{3+4i} = \frac{5-i}{3+4i} \cdot \frac{3-4i}{3-4i} = \frac{15-20i-3i+4i^2}{9-16i^2} = \frac{(15-4) + (-20-3)i}{9+16} = \frac{11-23i}{25} = \frac{11}{25} - \frac{23}{25}i$
41. $\frac{10i}{1-2i} = \frac{10i}{1-2i} \cdot \frac{1+2i}{1+2i} = \frac{10i+20i^2}{1-4i^2} = \frac{-20+10i}{1+4} = \frac{5(-4+2i)}{5} = -4+2i$
42. $(2-3i)^{-1} = \frac{1}{2-3i} = \frac{1}{2-3i} \cdot \frac{2+3i}{2+3i} = \frac{2+3i}{4-9i^2} = \frac{2+3i}{4+9} = \frac{2+3i}{13} = \frac{2}{13} + \frac{3}{13}i$
43. $\frac{4+6i}{3i} = \frac{4+6i}{3i} \cdot \frac{3i}{3i} = \frac{12i+18i^2}{9i^2} = \frac{-18+12i}{-9} = \frac{-18}{-9} + \frac{12}{-9}i = 2 - \frac{4}{3}i$
44. $\frac{-3+5i}{15i} = \frac{-3+5i}{15i} \cdot \frac{15i}{15i} = \frac{-45i+75i^2}{225i^2} = \frac{-75-45i}{-225} = \frac{-75}{-225} + \frac{-45}{-225}i = \frac{1}{3} + \frac{1}{5}i$
45. $\frac{1}{1+i} - \frac{1}{1-i} = \frac{1}{1+i} \cdot \frac{1-i}{1-i} - \frac{1}{1-i} \cdot \frac{1+i}{1+i} = \frac{1-i}{1-i^2} - \frac{1+i}{1-i^2} = \frac{1-i}{2} - \frac{1+i}{2} = \frac{1-i-1-i}{2} = -i$
46. $\frac{(1+2i)(3-i)}{2+i} = \frac{3-i+6i-2i^2}{2+i} = \frac{5+5i}{2+i} = \frac{5+5i}{2+i} \cdot \frac{2-i}{2-i} = \frac{10-5i+10i-5i^2}{4-i^2} = \frac{(10+5) + (-5+10)i}{5}$
 $= \frac{15+5i}{5} = \frac{15}{5} + \frac{5}{5}i = 3+i$
47. $i^3 = i^2i = -i$
48. $i^{10} = (i^2)^5 = (-1)^5 = -1$
49. $(3i)^5 = 3^5 (i^2)^2 i = 243 (-1)^2 i = 243i$
50. $(2i)^4 = 2^4 i^4 = 16(1) = 16$
51. $i^{1000} = (i^4)^{250} = 1^{250} = 1$
52. $i^{1002} = (i^4)^{250} i^2 = 1^{250} i^2 = -1$
53. $\sqrt{-49} = \sqrt{49}\sqrt{-1} = 7i$
54. $\sqrt{\frac{-81}{16}} = \frac{9}{4}i$
55. $\sqrt{-3}\sqrt{-12} = i\sqrt{3} \cdot 2i\sqrt{3} = 6i^2 = -6$
56. $\sqrt{\frac{1}{3}}\sqrt{-27} = \sqrt{\frac{1}{3}} \cdot 3i\sqrt{3} = 3i$
57. $(3 - \sqrt{-5})(1 + \sqrt{-1}) = (3 - i\sqrt{5})(1 + i) = 3 + 3i - i\sqrt{5} - i^2\sqrt{5} = (3 + \sqrt{5}) + (3 - \sqrt{5})i$

58. $(\sqrt{3} - \sqrt{-4})(\sqrt{6} - \sqrt{-8}) = (\sqrt{3} - 2i)(\sqrt{6} - 2i\sqrt{2}) = \sqrt{18} - 2i\sqrt{6} - 2i\sqrt{6} + 4i^2\sqrt{2}$
 $= (3\sqrt{2} - 4\sqrt{2}) + (-2\sqrt{6} - 2\sqrt{6})i = -\sqrt{2} - 4i\sqrt{6}$
59. $\frac{2 + \sqrt{-8}}{1 + \sqrt{-2}} = \frac{2 + 2i\sqrt{2}}{1 + i\sqrt{2}} = \frac{2(1 + i\sqrt{2})}{1 + i\sqrt{2}} = 2$
60. $\frac{\sqrt{-36}}{\sqrt{-2}\sqrt{-9}} = \frac{6i}{i\sqrt{2} \cdot 3i} = \frac{2}{i\sqrt{2}} \cdot \frac{i\sqrt{2}}{i\sqrt{2}} = \frac{2i\sqrt{2}}{2i^2} = \frac{i\sqrt{2}}{-1} = -i\sqrt{2}$
61. $x^2 + 49 = 0 \Leftrightarrow x^2 = -49 \Rightarrow x = \pm 7i$
62. $3x^2 + 1 = 0 \Leftrightarrow 3x^2 = -1 \Leftrightarrow x^2 = -\frac{1}{3} \Leftrightarrow x = \pm \frac{\sqrt{3}}{3}i$
63. $x^2 - x + 2 = 0 \Leftrightarrow x = \frac{-b \pm \sqrt{b^2 - 4ac}}{2a} = \frac{-(-1) \pm \sqrt{(-1)^2 - 4(1)(2)}}{2(1)} = \frac{1 \pm \sqrt{-7}}{2} = \frac{1}{2} \pm \frac{\sqrt{7}}{2}i$
64. $x^2 + 2x + 2 = 0 \Rightarrow x = \frac{-2 \pm \sqrt{(2)^2 - 4(1)(2)}}{2(1)} = \frac{-2 \pm \sqrt{4 - 8}}{2} = \frac{-2 \pm \sqrt{-4}}{2} = \frac{-2 \pm 2i}{2} = -1 \pm i$
65. $x^2 + 3x + 7 = 0 \Leftrightarrow x = \frac{-3 \pm \sqrt{3^2 - 4(1)(7)}}{2(1)} = \frac{-3 \pm \sqrt{-19}}{2} = -\frac{3}{2} \pm \frac{\sqrt{19}}{2}i$
66. $x^2 - 6x + 10 = 0 \Rightarrow x = \frac{-(-6) \pm \sqrt{(-6)^2 - 4(1)(10)}}{2(1)} = \frac{6 \pm \sqrt{36 - 40}}{2} = \frac{6 \pm \sqrt{-4}}{2} = \frac{6 \pm 2i}{2} = 3 \pm i$
67. $x^2 + x + 1 = 0 \Rightarrow x = \frac{-(1) \pm \sqrt{(1)^2 - 4(1)(1)}}{2(1)} = \frac{-1 \pm \sqrt{1 - 4}}{2} = \frac{-1 \pm \sqrt{-3}}{2} = \frac{-1 \pm i\sqrt{3}}{2} = -\frac{1}{2} \pm \frac{\sqrt{3}}{2}i$
68. $x^2 - 3x + 3 = 0 \Rightarrow x = \frac{-(-3) \pm \sqrt{(-3)^2 - 4(1)(3)}}{2(1)} = \frac{3 \pm \sqrt{9 - 12}}{2} = \frac{3 \pm \sqrt{-3}}{2} = \frac{3 \pm i\sqrt{3}}{2} = \frac{3}{2} \pm \frac{\sqrt{3}}{2}i$
69. $2x^2 - 2x + 1 = 0 \Rightarrow x = \frac{-(-2) \pm \sqrt{(-2)^2 - 4(2)(1)}}{2(2)} = \frac{2 \pm \sqrt{4 - 8}}{4} = \frac{2 \pm \sqrt{-4}}{4} = \frac{2 \pm 2i}{4} = \frac{1}{2} \pm \frac{1}{2}i$
70. $t + 3 + \frac{3}{t} = 0 \Leftrightarrow t^2 + 3t + 3 = 0 \Rightarrow t = \frac{-3 \pm \sqrt{(3)^2 - 4(1)(3)}}{2(1)} = \frac{-3 \pm \sqrt{9 - 12}}{2} = \frac{-3 \pm \sqrt{-3}}{2} = \frac{-3 \pm i\sqrt{3}}{2} = -\frac{3}{2} \pm \frac{\sqrt{3}}{2}i$
71. $6x^2 + 12x + 7 = 0 \Rightarrow$
 $x = \frac{-(12) \pm \sqrt{(12)^2 - 4(6)(7)}}{2(6)} = \frac{-12 \pm \sqrt{144 - 168}}{12} = \frac{-12 \pm \sqrt{-24}}{12} = \frac{-12 \pm 2i\sqrt{6}}{12} = \frac{-12}{12} \pm \frac{2i\sqrt{6}}{12} = -1 \pm \frac{\sqrt{6}}{6}i$
72. $x^2 + \frac{1}{2}x + 1 = 0 \Rightarrow$
 $x = \frac{-\left(\frac{1}{2}\right) \pm \sqrt{\left(\frac{1}{2}\right)^2 - 4(1)(1)}}{2(1)} = \frac{-\frac{1}{2} \pm \sqrt{\frac{1}{4} - 4}}{2} = \frac{-\frac{1}{2} \pm \sqrt{-\frac{15}{4}}}{2} = \frac{-\frac{1}{2} \pm \frac{1}{2}i\sqrt{15}}{2} = -\frac{1}{4} \pm \frac{\sqrt{15}}{4}i$
73. $\bar{z} + \bar{w} = \overline{3 - 4i} + \overline{5 + 2i} = 3 + 4i + 5 - 2i = 8 + 2i$
74. $\bar{z} + \bar{w} = \overline{3 - 4i} + \overline{5 + 2i} = 8 - 2i = 8 + 2i$
75. $z \cdot \bar{z} = (3 - 4i)(3 + 4i) = 3^2 + 4^2 = 25$
76. $\bar{z} \cdot \bar{w} = (3 + 4i)(5 - 2i) = 15 - 6i + 20i - 8i^2 = 23 + 14i$
77. LHS = $\bar{z} + \bar{w} = \overline{(a + bi)} + \overline{(c + di)} = a - bi + c - di = (a + c) + (-b - d)i = (a + c) - (b + d)i$.
RHS = $\bar{z} + \bar{w} = \overline{(a + bi)} + \overline{(c + di)} = \overline{(a + c) + (b + d)i} = (a + c) - (b + d)i$.
Since LHS = RHS, this proves the statement.
78. LHS = $\bar{z}\bar{w} = \overline{(a + bi)(c + di)} = \overline{ac + adi + bci + bdi^2} = \overline{(ac - bd) + (ad + bc)i} = (ac - bd) - (ad + bc)i$.
RHS = $\bar{z} \cdot \bar{w} = \overline{a + bi} \cdot \overline{c + di} = (a - bi)(c - di) = ac - adi - bci + bdi^2 = (ac - bd) - (ad + bc)i$.
Since LHS = RHS, this proves the statement.

$$79. \text{LHS} = (\bar{z})^2 = \overline{(a+bi)^2} = \overline{(a-bi)^2} = a^2 - 2abi + b^2i^2 = (a^2 - b^2) - 2abi.$$

$$\text{RHS} = \overline{z^2} = \overline{(a+bi)^2} = \overline{a^2 + 2abi + b^2i^2} = \overline{(a^2 - b^2) + 2abi} = (a^2 - b^2) - 2abi.$$

Since LHS = RHS, this proves the statement.

$$80. \overline{\bar{z}} = \overline{a+bi} = a-bi = a+bi = z.$$

$$81. z + \bar{z} = (a+bi) + \overline{(a+bi)} = a+bi + a-bi = 2a, \text{ which is a real number.}$$

$$82. z - \bar{z} = (a+bi) - \overline{(a+bi)} = a+bi - (a-bi) = a+bi - a+bi = 2bi, \text{ which is a pure imaginary number.}$$

$$83. z \cdot \bar{z} = (a+bi) \cdot \overline{(a+bi)} = (a+bi) \cdot (a-bi) = a^2 - b^2i^2 = a^2 + b^2, \text{ which is a real number.}$$

84. Suppose $z = \bar{z}$. Then we have $(a+bi) = \overline{(a+bi)} \Rightarrow a+bi = a-bi \Rightarrow 0 = -2bi \Rightarrow b = 0$, so z is real. Now if z is real, then $z = a + 0i$ (where a is real). Since $\bar{z} = a - 0i$, we have $z = \bar{z}$.

85. Using the Quadratic Formula, the solutions to the equation are $x = \frac{-b \pm \sqrt{b^2 - 4ac}}{2a}$. Since both solutions are imaginary,

we have $b^2 - 4ac < 0 \Leftrightarrow 4ac - b^2 > 0$, so the solutions are $x = \frac{-b}{2a} \pm \frac{\sqrt{4ac - b^2}}{2a}i$, where $\sqrt{4ac - b^2}$ is a real number.

Thus the solutions are complex conjugates of each other.

$$86. i = i, i^5 = i^4 \cdot i = i, i^9 = i^8 \cdot i = i; \quad i^2 = -1, i^6 = i^4 \cdot i^2 = -1, i^{10} = i^8 \cdot i^2 = -1;$$

$$i^3 = -i, i^7 = i^4 \cdot i^3 = -i, i^{11} = i^8 \cdot i^3 = -i; \quad i^4 = 1, i^8 = i^4 \cdot i^4 = 1, i^{12} = i^8 \cdot i^4 = 1.$$

Because $i^4 = 1$, we have $i^n = i^r$, where r is the remainder when n is divided by 4, that is, $n = 4 \cdot k + r$, where k is an integer and $0 \leq r < 4$. Since $4446 = 4 \cdot 1111 + 2$, we must have $i^{4446} = i^2 = -1$.

1.6 SOLVING OTHER TYPES OF EQUATIONS

Note: In cases where both sides of an equation are squared, the implication symbol \Leftrightarrow is sometimes used loosely. For example, $\sqrt{x} = x - 1$ “ \Leftrightarrow ” $(\sqrt{x})^2 = (x - 1)^2$ is valid only for positive x . In these cases, inadmissible solutions are identified later in the solution.

1. (a) To solve the equation $x^3 - 4x^2 = 0$ we *factor* the left-hand side: $x^2(x - 4) = 0$, as above.

(b) The solutions of the equation $x^2(x - 4) = 0$ are $x = 0$ and $x = 4$.

2. (a) Isolating the radical in $\sqrt{2x} + x = 0$, we obtain $\sqrt{2x} = -x$.

(b) Now square both sides: $(\sqrt{2x})^2 = (-x)^2 \Rightarrow 2x = x^2$.

(c) Solving the resulting quadratic equation, we find $2x = x^2 \Rightarrow x^2 - 2x = x(x - 2) = 0$, so the solutions are $x = 0$ and $x = 2$.

(d) We substitute these possible solutions into the original equation: $\sqrt{2 \cdot 0} + 0 = 0$, so $x = 0$ is a solution, but $\sqrt{2 \cdot 2} + 2 = 4 \neq 0$, so $x = 2$ is not a solution. The only real solution is $x = 0$.

3. The equation $(x + 1)^2 - 5(x + 1) + 6 = 0$ is of *quadratic* type. To solve the equation we set $W = x + 1$. The resulting quadratic equation is $W^2 - 5W + 6 = 0 \Leftrightarrow (W - 3)(W - 2) = 0 \Leftrightarrow W = 2$ or $W = 3 \Leftrightarrow x + 1 = 2$ or $x + 1 = 3 \Leftrightarrow x = 1$ or $x = 2$. You can verify that these are both solutions to the original equation.

4. The equation $x^6 + 7x^3 - 8 = 0$ is of *quadratic* type. To solve the equation we set $W = x^3$. The resulting quadratic equation is $W^2 + 7W - 8 = 0$.

5. $x^2 - x = 0 \Leftrightarrow x(x - 1) = 0 \Leftrightarrow x = 0$ or $x - 1 = 0$. Thus, the two real solutions are 0 and 1.

6. $3x^3 - 6x^2 = 0 \Leftrightarrow 3x^2(x - 2) = 0 \Leftrightarrow x = 0$ or $x - 2 = 0$. Thus, the two real solutions are 0 and 2.

7. $x^3 = 25x \Leftrightarrow x^3 - 25x = 0 \Leftrightarrow x(x^2 - 25) = 0 \Leftrightarrow x(x + 5)(x - 5) = 0 \Leftrightarrow x = 0$ or $x + 5 = 0$ or $x - 5 = 0$. The three real solutions are $-5, 0$, and 5 .

8. $x^5 = 5x^3 \Leftrightarrow x^5 - 5x^3 = 0 \Leftrightarrow x^3(x^2 - 5) = 0 \Leftrightarrow x = 0$ or $x^2 - 5 = 0$. The solutions are 0 and $\pm\sqrt{5}$.
9. $x^5 - 3x^2 = 0 \Leftrightarrow x^2(x^3 - 3) = 0 \Leftrightarrow x = 0$ or $x^3 - 3 = 0$. The solutions are 0 and $\sqrt[3]{3}$.
10. $6x^5 - 24x = 0 \Leftrightarrow 6x(x^4 - 4) = 0 \Leftrightarrow 6x(x^2 + 2)(x^2 - 2) = 0$. Thus, $x = 0$, or $x^2 + 2 = 0$ (which has no solution), or $x^2 - 2 = 0$. The solutions are 0 and $\pm\sqrt{2}$.
11. $0 = 4z^5 - 10z^2 = 2z^2(2z^3 - 5)$. If $2z^2 = 0$, then $z = 0$. If $2z^3 - 5 = 0$, then $2z^3 = 5 \Leftrightarrow z = \sqrt[3]{\frac{5}{2}}$. The solutions are 0 and $\sqrt[3]{\frac{5}{2}}$.
12. $0 = 125t^{10} - 2t^7 = t^7(125t^3 - 2)$. If $t^7 = 0$, then $t = 0$. If $125t^3 - 2 = 0$, then $t = \sqrt[3]{\frac{2}{125}} = \frac{\sqrt[3]{2}}{5}$. The solutions are 0 and $\frac{\sqrt[3]{2}}{5}$.
13. $0 = x^5 + 8x^2 = x^2(x^3 + 8) = x^2(x + 2)(x^2 - 2x + 4) \Leftrightarrow x^2 = 0$, $x + 2 = 0$, or $x^2 - 2x + 4 = 0$. If $x^2 = 0$, then $x = 0$; if $x + 2 = 0$, then $x = -2$, and $x^2 - 2x + 4 = 0$ has no real solution. Thus the solutions are $x = 0$ and $x = -2$.
14. $0 = x^4 + 64x = x(x^3 + 64) \Leftrightarrow x = 0$ or $x^3 + 64 = 0$. If $x^3 + 64 = 0$, then $x^3 = -64 \Leftrightarrow x = -4$. The solutions are 0 and -4 .
15. $0 = x^3 - 5x^2 + 6x = x(x^2 - 5x + 6) = x(x - 2)(x - 3) \Leftrightarrow x = 0$, $x - 2 = 0$, or $x - 3 = 0$. Thus $x = 0$, or $x = 2$, or $x = 3$. The solutions are $x = 0$, $x = 2$, and $x = 3$.
16. $0 = x^4 - x^3 - 6x^2 = x^2(x^2 - x - 6) = x^2(x - 3)(x + 2)$. Thus either $x^2 = 0$, so $x = 0$, or $x = 3$, or $x = -2$. The solutions are 0, 3, and -2 .
17. $0 = x^4 + 4x^3 + 2x^2 = x^2(x^2 + 4x + 2)$. So either $x^2 = 0 \Leftrightarrow x = 0$, or using the Quadratic Formula on $x^2 + 4x + 2 = 0$, we have $x = \frac{-4 \pm \sqrt{4^2 - 4(1)(2)}}{2(1)} = \frac{-4 \pm \sqrt{16 - 8}}{2} = \frac{-4 \pm \sqrt{8}}{2} = \frac{-4 \pm 2\sqrt{2}}{2} = -2 \pm \sqrt{2}$. The solutions are 0, $-2 - \sqrt{2}$, and $-2 + \sqrt{2}$.
18. $0 = y^5 - 8y^4 + 4y^3 = y^3(y^2 - 8y + 4)$. If $y^3 = 0$, then $y = 0$. If $y^2 - 8y + 4 = 0$, then using the Quadratic Formula, we have $y = \frac{-(-8) \pm \sqrt{(-8)^2 - 4(1)(4)}}{2(1)} = \frac{8 \pm \sqrt{48}}{2} = 4 \pm 2\sqrt{3}$. Thus, the three solutions are 0, $4 - 2\sqrt{3}$, and $4 + 2\sqrt{3}$.
19. $(3x + 5)^4 - (3x + 5)^3 = 0$. Let $y = 3x + 5$. The equation becomes $y^4 - y^3 = 0 \Leftrightarrow y(y^3 - 1) = y(y - 1)(y^2 + y + 1) = 0$. If $y = 0$, then $3x + 5 = 0 \Leftrightarrow x = -\frac{5}{3}$. If $y - 1 = 0$, then $3x + 5 - 1 = 0 \Leftrightarrow x = -\frac{4}{3}$. If $y^2 + y + 1 = 0$, then $(3x + 5)^2 + (3x + 5) + 1 = 0 \Leftrightarrow 9x^2 + 33x + 31 = 0$. The discriminant is $b^2 - 4ac = 33^2 - 4(9)(31) = -27 < 0$, so this case gives no real solution. The solutions are $x = -\frac{5}{3}$ and $x = -\frac{4}{3}$.
20. $(x + 5)^4 - 16(x + 5)^2 = 0$. Let $y = x + 5$. The equation becomes $y^4 - 16y^2 = y^2(y - 4)(y + 4) = 0$. If $y^2 = 0$, then $x + 5 = 0$ and $x = -5$. If $y - 4 = 0$, then $x + 5 - 4 = 0$ and $x = -1$. If $y + 4 = 0$, then $x + 5 + 4 = 0$ and $x = -9$. Thus, the solutions are -9 , -5 , and -1 .
21. $0 = x^3 - 5x^2 - 2x + 10 = x^2(x - 5) - 2(x - 5) = (x - 5)(x^2 - 2)$. If $x - 5 = 0$, then $x = 5$. If $x^2 - 2 = 0$, then $x^2 = 2 \Leftrightarrow x = \pm\sqrt{2}$. The solutions are 5 and $\pm\sqrt{2}$.
22. $0 = 2x^3 + x^2 - 18x - 9 = x^2(2x + 1) - 9(2x + 1) = (2x + 1)(x^2 - 9) = (2x + 1)(x - 3)(x + 3)$. The solutions are $-\frac{1}{2}$, 3, and -3 .
23. $x^3 - x^2 + x - 1 = x^2 + 1 \Leftrightarrow 0 = x^3 - 2x^2 + x - 2 = x^2(x - 2) + (x - 2) = (x - 2)(x^2 + 1)$. Since $x^2 + 1 = 0$ has no real solution, the only solution comes from $x - 2 = 0 \Leftrightarrow x = 2$.

24. $7x^3 - x + 1 = x^3 + 3x^2 + x \Leftrightarrow 0 = 6x^3 - 3x^2 - 2x + 1 = 3x^2(2x - 1) - (2x - 1) = (2x - 1)(3x^2 - 1) \Leftrightarrow 2x - 1 = 0$
or $3x^2 - 1 = 0$. If $2x - 1 = 0$, then $x = \frac{1}{2}$. If $3x^2 - 1 = 0$, then $3x^2 = 1 \Leftrightarrow x^2 = \frac{1}{3} \Leftrightarrow x = \pm\sqrt{\frac{1}{3}}$. The solutions are $\frac{1}{2}$
and $\pm\sqrt{\frac{1}{3}}$.
25. $z + \frac{4}{z+1} = 3 \Leftrightarrow (z+1)\left(z + \frac{4}{z+1}\right) = (z+1)(3) \Leftrightarrow z^2 + z + 4 = 3z + 3 \Leftrightarrow z^2 - 2z + 1 = 0 \Leftrightarrow (z-1)^2 = 0$. The
solution is $z = 1$. We must check the original equation to make sure this value of z does not result in a zero denominator.
26. $\frac{10}{m+5} + 15 = 3m \Leftrightarrow (m+5)\left(\frac{10}{m+5} + 15\right) = (m+5)(3m) \Leftrightarrow 10 + 15m + 75 = 3m^2 + 15m \Leftrightarrow 3m^2 - 85 = 0 \Leftrightarrow$
 $m = \pm\sqrt{\frac{85}{3}}$. Verifying that neither of these values of m results in a zero denominator in the original equation, we see that
the solutions are $-\sqrt{\frac{85}{3}}$ and $\sqrt{\frac{85}{3}}$.
27. $\frac{1}{x-1} + \frac{1}{x+2} = \frac{5}{4} \Leftrightarrow 4(x-1)(x+2)\left(\frac{1}{x-1} + \frac{1}{x+2}\right) = 4(x-1)(x+2)\left(\frac{5}{4}\right) \Leftrightarrow$
 $4(x+2) + 4(x-1) = 5(x-1)(x+2) \Leftrightarrow 4x + 8 + 4x - 4 = 5x^2 + 5x - 10 \Leftrightarrow 5x^2 - 3x - 14 = 0 \Leftrightarrow$
 $(5x+7)(x-2) = 0$. If $5x+7 = 0$, then $x = -\frac{7}{5}$; if $x-2 = 0$, then $x = 2$. The solutions are $-\frac{7}{5}$ and 2 .
28. $\frac{10}{x} - \frac{12}{x-3} + 4 = 0 \Leftrightarrow x(x-3)\left(\frac{10}{x} - \frac{12}{x-3} + 4\right) = 0 \Leftrightarrow (x-3)10 - 12x + 4x(x-3) = 0 \Leftrightarrow$
 $10x - 30 - 12x + 4x^2 - 12x = 0 \Leftrightarrow 4x^2 - 14x - 30 = 0$. Using the Quadratic Formula, we have
 $x = \frac{-(-14) \pm \sqrt{(-14)^2 - 4(4)(-30)}}{2(4)} = \frac{14 \pm \sqrt{196 + 480}}{8} = \frac{14 \pm \sqrt{676}}{8} = \frac{14 \pm 26}{8}$. So the solutions are 5 and $-\frac{3}{2}$.
29. $\frac{x^2}{x+100} = 50 \Leftrightarrow x^2 = 50(x+100) = 50x + 5000 \Leftrightarrow x^2 - 50x - 5000 = 0 \Leftrightarrow (x-100)(x+50) = 0 \Leftrightarrow x-100 = 0$
or $x+50 = 0$. Thus $x = 100$ or $x = -50$. The solutions are 100 and -50 .
30. $\frac{2x}{x^2+1} = 1 \Leftrightarrow 2x = x^2 + 1 \Leftrightarrow x^2 - 2x + 1 = (x-1)^2 = 0$, so $x = 1$. This is indeed a solution to the original equation.
31. $1 + \frac{1}{(x+1)(x+2)} = \frac{2}{x+1} + \frac{1}{x+2} \Leftrightarrow (x+1)(x+2) + 1 = 2(x+2) + (x+1) \Leftrightarrow x^2 + 3x + 2 + 1 = 2x + 4 + x + 1$
 $\Leftrightarrow x^2 - 2 = 0 \Leftrightarrow x = \pm\sqrt{2}$. We verify that these are both solutions to the original equation.
32. $\frac{x}{x+3} = \frac{2}{x-3} - \frac{1}{x^2-9} \Leftrightarrow x(x-3) = 2(x+3) - 1 \Leftrightarrow x^2 - 3x = 2x + 6 - 1 \Leftrightarrow x^2 - 5x - 5 = 0$. Using the Quadratic
Formula, $x = \frac{-(-5) \pm \sqrt{(-5)^2 - 4(1)(-5)}}{2} = \frac{5 \pm 3\sqrt{5}}{2}$. We verify that both are solutions to the original equation.
33. $\frac{x}{2x+7} - \frac{x+1}{x+3} = 1 \Leftrightarrow x(x+3) - (x+1)(2x+7) = (2x+7)(x+3) \Leftrightarrow x^2 + 3x - 2x^2 - 9x - 7 = 2x^2 + 13x + 21$
 $\Leftrightarrow 3x^2 + 19x + 28 = 0 \Leftrightarrow (3x+7)(x+4) = 0$. Thus either $3x+7 = 0$, so $x = -\frac{7}{3}$, or $x = -4$. The solutions are $-\frac{7}{3}$
and -4 .
34. $\frac{1}{x-1} - \frac{2}{x^2} = 0 \Leftrightarrow x^2 - 2(x-1) = 0 \Leftrightarrow x^2 - 2x + 2 = 0 \Leftrightarrow$
 $x = \frac{-(-2) \pm \sqrt{(-2)^2 - 4(1)(2)}}{2(1)} = \frac{2 \pm \sqrt{4-8}}{2} = \frac{2 \pm \sqrt{-4}}{2}$. Since the radicand is negative, there is no real solution.

35. $\frac{x + \frac{2}{x}}{3 + \frac{4}{x}} = 5x \Leftrightarrow \left(\frac{x + \frac{2}{x}}{3 + \frac{4}{x}}\right) \cdot \frac{x}{x} = \frac{x^2 + 2}{3x + 4} = 5x \Leftrightarrow x^2 + 2 = 5x(3x + 4) \Leftrightarrow x^2 + 2 = 15x^2 + 20x \Leftrightarrow 0 = 14x^2 + 20x - 2$
 $\Leftrightarrow x = \frac{-(20) \pm \sqrt{(20)^2 - 4(14)(-2)}}{2(14)} = \frac{-20 \pm \sqrt{400 + 112}}{28} = \frac{-20 \pm \sqrt{512}}{28} = \frac{-20 \pm 16\sqrt{2}}{28} = \frac{-5 \pm 4\sqrt{2}}{7}$. The solutions are $\frac{-5 \pm 4\sqrt{2}}{7}$.
36. $\frac{3 + \frac{1}{x}}{2 - \frac{4}{x}} = x \Leftrightarrow x \left(2 - \frac{4}{x}\right) \left(\frac{3 + \frac{1}{x}}{2 - \frac{4}{x}}\right) = x \left(2 - \frac{4}{x}\right) x \Leftrightarrow 3x + 1 = 2x^2 - 4x \Leftrightarrow 2x^2 - 7x - 1 = 0$. Using the Quadratic Formula, we find $x = \frac{-(-7) \pm \sqrt{(-7)^2 - 4(2)(-1)}}{2(2)} = \frac{7 \pm \sqrt{57}}{4}$. Both are admissible, so the solutions are $\frac{7 \pm \sqrt{57}}{4}$.
37. $5 = \sqrt{4x - 3} \Leftrightarrow 5^2 = (\sqrt{4x - 3})^2 \Leftrightarrow 25 = 4x - 3 \Leftrightarrow 4x = 28 \Leftrightarrow x = 7$ is a potential solution. Substituting into the original equation, we get $5 = \sqrt{4(7) - 3} \Leftrightarrow 5 = \sqrt{25}$, which is true, so the solution is $x = 7$.
38. $\sqrt{8x - 1} = 3 \Leftrightarrow (\sqrt{8x - 1})^2 = 3^2 \Leftrightarrow 8x - 1 = 9 \Leftrightarrow x = \frac{5}{4}$. Substituting into the original equation, we get $\sqrt{8\left(\frac{5}{4}\right) - 1} = 3 \Leftrightarrow \sqrt{9} = 3$, which is true, so the solution is $x = \frac{5}{4}$.
39. $\sqrt{2x - 1} = \sqrt{3x - 5} \Leftrightarrow (\sqrt{2x - 1})^2 = (\sqrt{3x - 5})^2 \Leftrightarrow 2x - 1 = 3x - 5 \Leftrightarrow x = 4$. Substituting into the original equation, we get $\sqrt{2(4) - 1} = \sqrt{3(4) - 5} \Leftrightarrow \sqrt{7} = \sqrt{7}$, which is true, so the solution is $x = 4$.
40. $\sqrt{3 + x} = \sqrt{x^2 + 1} \Leftrightarrow (\sqrt{3 + x})^2 = (\sqrt{x^2 + 1})^2 \Leftrightarrow 3 + x = x^2 + 1 \Leftrightarrow x^2 - x - 2 = 0 \Leftrightarrow (x + 1)(x - 2) = 0 \Leftrightarrow x = -1$ or $x = 2$. Substituting into the original equation, we get $\sqrt{3 + (-1)} = \sqrt{(-1)^2 + 1} \Leftrightarrow \sqrt{2} = \sqrt{2}$, which is true, and $\sqrt{3 + 2} = \sqrt{2^2 + 1}$, which is also true. So the solutions are $x = -1$ and $x = 2$.
41. $\sqrt{x + 2} = x \Leftrightarrow (\sqrt{x + 2})^2 = x^2 \Leftrightarrow x + 2 = x^2 \Leftrightarrow x^2 - x - 2 = (x + 1)(x - 2) = 0 \Leftrightarrow x = -1$ or $x = 2$. Substituting into the original equation, we get $\sqrt{(-1) + 2} = -1 \Leftrightarrow \sqrt{1} = -1$, which is false, and $\sqrt{2 + 2} = 2 \Leftrightarrow \sqrt{4} = 2$, which is true. So $x = 2$ is the only real solution.
42. $\sqrt{4 - 6x} = 2x \Leftrightarrow (\sqrt{4 - 6x})^2 = (2x)^2 \Leftrightarrow 4 - 6x = 4x^2 \Leftrightarrow 2x^2 + 3x - 2 = (x + 2)(2x - 1) = 0 \Leftrightarrow x = -2$ or $x = \frac{1}{2}$. Substituting into the original equation, we get $\sqrt{4 - 6(-2)} = 2(-2) \Leftrightarrow \sqrt{16} = -4$, which is false, and $\sqrt{4 - 6\left(\frac{1}{2}\right)} = 2\left(\frac{1}{2}\right) \Leftrightarrow \sqrt{1} = 1$, which is true. So $x = \frac{1}{2}$ is the only real solution.
43. $\sqrt{2x + 1} + 1 = x \Leftrightarrow \sqrt{2x + 1} = x - 1 \Leftrightarrow 2x + 1 = (x - 1)^2 \Leftrightarrow 2x + 1 = x^2 - 2x + 1 \Leftrightarrow 0 = x^2 - 4x = x(x - 4)$. Potential solutions are $x = 0$ and $x = 4 \Leftrightarrow x = 4$. These are only potential solutions since squaring is not a reversible operation. We must check each potential solution in the original equation.
 Checking $x = 0$: $\sqrt{2(0) + 1} + 1 = (0) \Leftrightarrow \sqrt{1} + 1 = 0$ is false.
 Checking $x = 4$: $\sqrt{2(4) + 1} + 1 = (4) \Leftrightarrow \sqrt{9} + 1 = 4 \Leftrightarrow 3 + 1 = 4$ is true. The only solution is $x = 4$.
44. $x - \sqrt{9 - 3x} = 0 \Leftrightarrow x = \sqrt{9 - 3x} \Leftrightarrow x^2 = 9 - 3x \Leftrightarrow 0 = x^2 + 3x - 9$. Using the Quadratic Formula to find the potential solutions, we have $x = \frac{-3 \pm \sqrt{3^2 - 4(1)(-9)}}{2(1)} = \frac{-3 \pm \sqrt{45}}{2} = \frac{-3 \pm 3\sqrt{5}}{2}$. Substituting each of these solutions into the original equation, we see that $x = \frac{-3 + 3\sqrt{5}}{2}$ is a solution, but $x = \frac{-3 - 3\sqrt{5}}{2}$ is not. Thus $x = \frac{-3 + 3\sqrt{5}}{2}$ is the only solution.
45. $x - \sqrt{x - 1} = 3 \Leftrightarrow x - 3 = \sqrt{x - 1} \Leftrightarrow (x - 3)^2 = (\sqrt{x - 1})^2 \Leftrightarrow x^2 - 6x + 9 = x - 1 \Leftrightarrow x^2 - 7x + 10 = 0 \Leftrightarrow (x - 2)(x - 5) = 0$. Potential solutions are $x = 2$ and $x = 5$. We must check each potential solution in the original equation. Checking $x = 2$: $2 - \sqrt{2 - 1} = 3$, which is false, so $x = 2$ is not a solution. Checking $x = 5$: $5 - \sqrt{5 - 1} = 3 \Leftrightarrow 5 - 2 = 3$, which is true, so $x = 5$ is the only solution.

46. $\sqrt{3-x} + 2 = 1 - x \Leftrightarrow \sqrt{3-x} = -1 - x \Leftrightarrow (\sqrt{3-x})^2 = (-1-x)^2 \Leftrightarrow 3-x = x^2 + 2x + 1 \Leftrightarrow x^2 + 3x - 2 = 0$. Using the Quadratic Formula to find the potential solutions, we have $x = \frac{-3 \pm \sqrt{3^2 - 4(1)(-2)}}{2(1)} = \frac{-3 \pm \sqrt{17}}{2}$. Substituting each of these solutions into the original equation, we see that $x = \frac{-3 - \sqrt{17}}{2}$ is a solution, but $x = \frac{-3 + \sqrt{17}}{2}$ is not. Thus $x = \frac{-3 - \sqrt{17}}{2}$ is the only solution.
47. $\sqrt{3x+1} = 2 + \sqrt{x+1} \Leftrightarrow (\sqrt{3x+1})^2 = (2 + \sqrt{x+1})^2 \Leftrightarrow 3x+1 = 4 + 4\sqrt{x+1} + x+1 \Leftrightarrow 2x-4 = 4\sqrt{x+1} \Leftrightarrow x-2 = 2\sqrt{x+1} \Leftrightarrow (x-2)^2 = (2\sqrt{x+1})^2 \Leftrightarrow x^2 - 4x + 4 = 4(x+1) \Leftrightarrow x^2 - 8x = 0 \Leftrightarrow x(x-8) = 0 \Leftrightarrow x = 0$ or $x = 8$. Substituting each of these solutions into the original equation, we see that $x = 0$ is not a solution but $x = 8$ is a solution. Thus, $x = 8$ is the only solution.
48. $\sqrt{1+x} + \sqrt{1-x} = 2 \Leftrightarrow (\sqrt{1+x} + \sqrt{1-x})^2 = 2^2 \Leftrightarrow (1+x) + (1-x) + 2\sqrt{1+x}\sqrt{1-x} = 4 \Leftrightarrow 2 + 2\sqrt{1+x}\sqrt{1-x} = 4 \Leftrightarrow \sqrt{1+x}\sqrt{1-x} = 1 \Leftrightarrow (1+x)(1-x) = 1 \Leftrightarrow 1-x^2 = 1 \Leftrightarrow x^2 = 0$, so $x = 0$. We verify that this is a solution to the original equation.
49. $x^4 - 4x^2 + 3 = 0$. Let $y = x^2$. Then the equation becomes $y^2 - 4y + 3 = 0 \Leftrightarrow (y-1)(y-3) = 0$, so $y = 1$ or $y = 3$. If $y = 1$, then $x^2 = 1 \Leftrightarrow x = \pm 1$, and if $y = 3$, then $x^2 = 3 \Leftrightarrow x = \pm\sqrt{3}$.
50. $x^4 - 5x^2 + 6 = 0$. Let $y = x^2$. Then the equation becomes $y^2 - 5y + 6 = 0 \Leftrightarrow (y-2)(y-3) = 0$, so $y = 2$ or $y = 3$. If $y = 2$, then $x^2 = 2 \Leftrightarrow x = \pm\sqrt{2}$, and if $y = 3$, then $x^2 = 3 \Leftrightarrow x = \pm\sqrt{3}$.
51. $2x^4 + 4x^2 + 1 = 0$. The LHS is the sum of two nonnegative numbers and a positive number, so $2x^4 + 4x^2 + 1 \geq 1 \neq 0$. This equation has no real solution.
52. $0 = x^6 - 2x^3 - 3 = (x^3 - 3)(x^3 + 1)$. If $x^3 - 3 = 0$, then $x^3 = 3 \Leftrightarrow x = \sqrt[3]{3}$, or if $x^3 + 1 = 0 \Leftrightarrow x^3 = -1 \Leftrightarrow x = -1$. Thus $x = \sqrt[3]{3}$ or $x = -1$. The solutions are $\sqrt[3]{3}$ and -1 .
53. $0 = x^6 - 26x^3 - 27 = (x^3 - 27)(x^3 + 1)$. If $x^3 - 27 = 0 \Leftrightarrow x^3 = 27$, so $x = 3$. If $x^3 + 1 = 0 \Leftrightarrow x^3 = -1$, so $x = -1$. The solutions are 3 and -1 .
54. $x^8 + 15x^4 + 16 = 0 \Leftrightarrow 0 = x^8 + 15x^4 - 16 = (x^4 + 16)(x^4 - 1)$. If $x^4 + 16 = 0$, then $x^4 = -16$ which is impossible (for real numbers). If $x^4 - 1 = 0 \Leftrightarrow x^4 = 1$, so $x = \pm 1$. The solutions are 1 and -1 .
55. $0 = (x+5)^2 - 3(x+5) - 10 = [(x+5) - 5][(x+5) + 2] = x(x+7) \Leftrightarrow x = 0$ or $x = -7$. The solutions are 0 and -7 .
56. Let $w = \frac{x+1}{x}$. Then $0 = \left(\frac{x+1}{x}\right)^2 + 4\left(\frac{x+1}{x}\right) + 3$ becomes $0 = w^2 + 4w + 3 = (w+1)(w+3)$. Now if $w+1 = 0$, then $\frac{x+1}{x} + 1 = 0 \Leftrightarrow \frac{x+1}{x} = -1 \Leftrightarrow x+1 = -x \Leftrightarrow x = -\frac{1}{2}$, and if $w+3 = 0$, then $\frac{x+1}{x} + 3 = 0 \Leftrightarrow \frac{x+1}{x} = -3 \Leftrightarrow x+1 = -3x \Leftrightarrow x = -\frac{1}{4}$. The solutions are $-\frac{1}{2}$ and $-\frac{1}{4}$.
57. Let $w = \frac{1}{x+1}$. Then $\left(\frac{1}{x+1}\right)^2 - 2\left(\frac{1}{x+1}\right) - 8 = 0$ becomes $w^2 - 2w - 8 = 0 \Leftrightarrow (w-4)(w+2) = 0$. So $w-4 = 0 \Leftrightarrow w = 4$, and $w+2 = 0 \Leftrightarrow w = -2$. When $w = 4$, we have $\frac{1}{x+1} = 4 \Leftrightarrow 1 = 4x+4 \Leftrightarrow -3 = 4x \Leftrightarrow x = -\frac{3}{4}$. When $w = -2$, we have $\frac{1}{x+1} = -2 \Leftrightarrow 1 = -2x-2 \Leftrightarrow 3 = -2x \Leftrightarrow x = -\frac{3}{2}$. Solutions are $-\frac{3}{4}$ and $-\frac{3}{2}$.
58. Let $w = \frac{x}{x+2}$. Then $\left(\frac{x}{x+2}\right)^2 = \frac{4x}{x+2} - 4$ becomes $w^2 = 4w - 4 \Leftrightarrow 0 = w^2 - 4w + 4 = (w-2)^2$. Now if $w-2 = 0$, then $\frac{x}{x+2} - 2 = 0 \Leftrightarrow \frac{x}{x+2} = 2 \Leftrightarrow x = 2x+4 \Leftrightarrow x = -4$. The solution is -4 .

59. Let $u = x^{2/3}$. Then $0 = x^{4/3} - 5x^{2/3} + 6$ becomes $u^2 - 5u + 6 = 0 \Leftrightarrow (u - 3)(u - 2) = 0 \Leftrightarrow u - 3 = 0$ or $u - 2 = 0$. If $u - 3 = 0$, then $x^{2/3} - 3 = 0 \Leftrightarrow x^{2/3} = 3 \Leftrightarrow x = \pm 3^{3/2} = \pm 3\sqrt{3}$. If $u - 2 = 0$, then $x^{2/3} - 2 = 0 \Leftrightarrow x^{2/3} = 2 \Leftrightarrow x = \pm 2^{3/2} = 2\sqrt{2}$. The solutions are $\pm 3\sqrt{3}$ and $\pm 2\sqrt{2}$.
60. Let $u = \sqrt[4]{x}$; then $0 = \sqrt{x} - 3\sqrt[4]{x} - 4 = u^2 - 3u - 4 = (u - 4)(u + 1)$. So $u - 4 = \sqrt[4]{x} - 4 = 0 \Leftrightarrow \sqrt[4]{x} = 4 \Leftrightarrow x = 4^4 = 256$, or $u + 1 = \sqrt[4]{x} + 1 = 0 \Leftrightarrow \sqrt[4]{x} = -1$. However, $\sqrt[4]{x}$ is the positive fourth root, so this cannot equal -1 . The only solution is 256.
61. $4(x + 1)^{1/2} - 5(x + 1)^{3/2} + (x + 1)^{5/2} = 0 \Leftrightarrow \sqrt{x + 1} [4 - 5(x + 1) + (x + 1)^2] = 0 \Leftrightarrow \sqrt{x + 1} (4 - 5x - 5 + x^2 + 2x + 1) = 0 \Leftrightarrow \sqrt{x + 1} (x^2 - 3x) = 0 \Leftrightarrow \sqrt{x + 1} \cdot x(x - 3) = 0 \Leftrightarrow x = -1$ or $x = 0$ or $x = 3$. The solutions are $-1, 0$, and 3 .
62. Let $u = x - 4$; then $0 = 2(x - 4)^{7/3} - (x - 4)^{4/3} - (x - 4)^{1/3} = 2u^{7/3} - u^{4/3} - u^{1/3} = u^{1/3}(2u + 1)(u - 1)$. So $u = x - 4 = 0 \Leftrightarrow x = 4$, or $2u + 1 = 2(x - 4) + 1 = 2x - 7 = 0 \Leftrightarrow 2x = 7 \Leftrightarrow x = \frac{7}{2}$, or $u - 1 = (x - 4) - 1 = x - 5 = 0 \Leftrightarrow x = 5$. The solutions are $4, \frac{7}{2}$, and 5 .
63. $x^{3/2} - 10x^{1/2} + 25x^{-1/2} = 0 \Leftrightarrow x^{-1/2}(x^2 - 10x + 25) = 0 \Leftrightarrow x^{-1/2}(x - 5)^2 = 0$. Now $x^{-1/2} \neq 0$, so the only solution is $x = 5$.
64. $x^{1/2} - x^{-1/2} - 6x^{-3/2} = 0 \Leftrightarrow x^{-3/2}(x^2 - x - 6) = 0 \Leftrightarrow x^{-3/2}(x + 2)(x - 3) = 0$. Now $x^{-1/2} \neq 0$, and furthermore the original equation cannot have a negative solution. Thus, the only solution is $x = 3$.
65. Let $u = x^{1/6}$. (We choose the exponent $\frac{1}{6}$ because the LCD of 2, 3, and 6 is 6.) Then $x^{1/2} - 3x^{1/3} = 3x^{1/6} - 9 \Leftrightarrow x^{3/6} - 3x^{2/6} = 3x^{1/6} - 9 \Leftrightarrow x^3 - 3x^2 = 3u - 9 \Leftrightarrow 0 = u^3 - 3u^2 - 3u + 9 = u^2(u - 3) - 3(u - 3) = (u - 3)(u^2 - 3)$. So $u - 3 = 0$ or $u^2 - 3 = 0$. If $u - 3 = 0$, then $x^{1/6} - 3 = 0 \Leftrightarrow x^{1/6} = 3 \Leftrightarrow x = 3^6 = 729$. If $u^2 - 3 = 0$, then $x^{1/3} - 3 = 0 \Leftrightarrow x^{1/3} = 3 \Leftrightarrow x = 3^3 = 27$. The solutions are 729 and 27.
66. Let $u = \sqrt{x}$. Then $0 = x - 5\sqrt{x} + 6$ becomes $u^2 - 5u + 6 = (u - 3)(u - 2) = 0$. If $u - 3 = 0$, then $\sqrt{x} - 3 = 0 \Leftrightarrow \sqrt{x} = 3 \Leftrightarrow x = 9$. If $u - 2 = 0$, then $\sqrt{x} - 2 = 0 \Leftrightarrow \sqrt{x} = 2 \Leftrightarrow x = 4$. The solutions are 9 and 4.
67. $\frac{1}{x^3} + \frac{4}{x^2} + \frac{4}{x} = 0 \Leftrightarrow 1 + 4x + 4x^2 = 0 \Leftrightarrow (1 + 2x)^2 = 0 \Leftrightarrow 1 + 2x = 0 \Leftrightarrow 2x = -1 \Leftrightarrow x = -\frac{1}{2}$. The solution is $-\frac{1}{2}$.
68. $0 = 4x^{-4} - 16x^{-2} + 4$. Multiplying by $\frac{x^4}{4}$ we get, $0 = 1 - 4x^2 + x^4$. Substituting $u = x^2$, we get $0 = 1 - 4u + u^2$, and using the Quadratic Formula, we get $u = \frac{-(-4) \pm \sqrt{(-4)^2 - 4(1)(1)}}{2(1)} = \frac{4 \pm \sqrt{16 - 4}}{2} = \frac{4 \pm \sqrt{12}}{2} = \frac{4 \pm 2\sqrt{3}}{2} = 2 \pm \sqrt{3}$. Substituting back, we have $x^2 = 2 \pm \sqrt{3}$, and since $2 + \sqrt{3}$ and $2 - \sqrt{3}$ are both positive we have $x = \pm\sqrt{2 + \sqrt{3}}$ or $x = \pm\sqrt{2 - \sqrt{3}}$. Thus the solutions are $-\sqrt{2 - \sqrt{3}}, \sqrt{2 - \sqrt{3}}, -\sqrt{2 + \sqrt{3}},$ and $\sqrt{2 + \sqrt{3}}$.
69. $\sqrt{\sqrt{x + 5} + x} = 5$. Squaring both sides, we get $\sqrt{x + 5} + x = 25 \Leftrightarrow \sqrt{x + 5} = 25 - x$. Squaring both sides again, we get $x + 5 = (25 - x)^2 \Leftrightarrow x + 5 = 625 - 50x + x^2 \Leftrightarrow 0 = x^2 - 51x + 620 = (x - 20)(x - 31)$. Potential solutions are $x = 20$ and $x = 31$. We must check each potential solution in the original equation.
Checking $x = 20$: $\sqrt{\sqrt{20 + 5} + 20} = 5 \Leftrightarrow \sqrt{\sqrt{25} + 20} = 5 \Leftrightarrow \sqrt{5 + 20} = 5$, which is true, and hence $x = 20$ is a solution.
Checking $x = 31$: $\sqrt{\sqrt{(31) + 5} + 31} = 5 \Leftrightarrow \sqrt{\sqrt{36} + 31} = 5 \Leftrightarrow \sqrt{37} = 5$, which is false, and hence $x = 31$ is not a solution. The only real solution is $x = 20$.
70. $\sqrt[3]{4x^2 - 4x} = x \Leftrightarrow 4x^2 - 4x = x^3 \Leftrightarrow 0 = x^3 - 4x^2 + 4x = x(x^2 - 4x + 4) = x(x - 2)^2$. So $x = 0$ or $x = 2$. The solutions are 0 and 2.

71. $x^2\sqrt{x+3} = (x+3)^{3/2} \Leftrightarrow 0 = x^2\sqrt{x+3} - (x+3)^{3/2} \Leftrightarrow 0 = \sqrt{x+3} \left[(x^2) - (x+3) \right] \Leftrightarrow 0 = \sqrt{x+3} (x^2 - x - 3)$.

If $(x+3)^{1/2} = 0$, then $x+3 = 0 \Leftrightarrow x = -3$. If $x^2 - x - 3 = 0$, then using the Quadratic Formula $x = \frac{1 \pm \sqrt{13}}{2}$. The solutions are -3 and $\frac{1 \pm \sqrt{13}}{2}$.

72. Let $u = \sqrt{11 - x^2}$. By definition of u we require it to be nonnegative. Now $\sqrt{11 - x^2} - \frac{2}{\sqrt{11 - x^2}} = 1 \Leftrightarrow u - \frac{2}{u} = 1$.

Multiplying both sides by u we obtain $u^2 - 2 = u \Leftrightarrow 0 = u^2 - u - 2 = (u - 2)(u + 1)$. So $u = 2$ or $u = -1$. But since u must be nonnegative, we only have $u = 2 \Leftrightarrow \sqrt{11 - x^2} = 2 \Leftrightarrow 11 - x^2 = 4 \Leftrightarrow x^2 = 7 \Leftrightarrow x = \pm\sqrt{7}$. The solutions are $\pm\sqrt{7}$.

73. $\sqrt{x + \sqrt{x+2}} = 2$. Squaring both sides, we get $x + \sqrt{x+2} = 4 \Leftrightarrow \sqrt{x+2} = 4 - x$. Squaring both sides again, we get $x + 2 = (4 - x)^2 = 16 - 8x + x^2 \Leftrightarrow 0 = x^2 - 9x + 14 \Leftrightarrow 0 = (x - 7)(x - 2)$. If $x - 7 = 0$, then $x = 7$. If $x - 2 = 0$, then $x = 2$. So $x = 2$ is a solution but $x = 7$ is not, since it does not satisfy the original equation.

74. $\sqrt{1 + \sqrt{x + \sqrt{2x+1}}} = \sqrt{5 + \sqrt{x}}$. We square both sides to get $1 + \sqrt{x + \sqrt{2x+1}} = 5 + \sqrt{x} \Leftrightarrow x + \sqrt{2x+1} = (4 + \sqrt{x})^2 = 16 + 8\sqrt{x} + x \Leftrightarrow \sqrt{2x+1} = 16 + 8\sqrt{x}$. Again, squaring both sides, we obtain $2x + 1 = (16 + 8\sqrt{x})^2 = 256 + 256\sqrt{x} + 64x \Leftrightarrow -62x - 255 = 256\sqrt{x}$. We could continue squaring both sides until we found possible solutions; however, consider the last equation. Since we are working with real numbers, for \sqrt{x} to be defined, we must have $x \geq 0$. Then $-62x - 255 < 0$ while $256\sqrt{x} \geq 0$, so there is no solution.

75. $0 = x^4 - 5ax^2 + 4a^2 = (a - x^2)(4a - x^2)$. Since a is positive, $a - x^2 = 0 \Leftrightarrow x^2 = a \Leftrightarrow x = \pm\sqrt{a}$. Again, since a is positive, $4a - x^2 = 0 \Leftrightarrow x^2 = 4a \Leftrightarrow x = \pm 2\sqrt{a}$. Thus the four solutions are $\pm\sqrt{a}$ and $\pm 2\sqrt{a}$.

76. $0 = a^3x^3 + b^3 = (ax + b)(a^2x^2 - abx + b^2)$. So $ax + b = 0 \Leftrightarrow ax = -b \Leftrightarrow x = -\frac{b}{a}$ or $x = \frac{-(-ab) \pm \sqrt{(-ab)^2 - 4(a^2)(b^2)}}{2(a^2)} = \frac{ab \pm \sqrt{-3a^2b^2}}{2a^2}$, but this gives no real solution. Thus, the solution is $x = -\frac{b}{a}$.

77. $\sqrt{x+a} + \sqrt{x-a} = \sqrt{2\sqrt{x+6}}$. Squaring both sides, we have $x + a + 2(\sqrt{x+a})(\sqrt{x-a}) + x - a = 2(x+6) \Leftrightarrow 2x + 2(\sqrt{x+a})(\sqrt{x-a}) = 2x + 12 \Leftrightarrow 2(\sqrt{x+a})(\sqrt{x-a}) = 12 \Leftrightarrow (\sqrt{x+a})(\sqrt{x-a}) = 6$. Squaring both sides again we have $(x+a)(x-a) = 36 \Leftrightarrow x^2 - a^2 = 36 \Leftrightarrow x^2 = a^2 + 36 \Leftrightarrow x = \pm\sqrt{a^2 + 36}$. Checking these answers, we see that $x = -\sqrt{a^2 + 36}$ is not a solution (for example, try substituting $a = 8$), but $x = \sqrt{a^2 + 36}$ is a solution.

78. Let $w = x^{1/6}$. Then $x^{1/3} = w^2$ and $x^{1/2} = w^3$, and so $0 = w^3 - aw^2 + bw - ab = w^2(w - a) + b(w - a) = (w^2 + b)(w - a) = (\sqrt[3]{x} + b)(\sqrt[6]{x} - a)$. So $\sqrt[6]{x} - a = 0 \Leftrightarrow a = \sqrt[6]{x} \Leftrightarrow x = a^6$ is one solution. Setting the first factor equal to zero, we have $\sqrt[3]{x} + b = 0 \Leftrightarrow \sqrt[3]{x} = -b \Leftrightarrow x = -b^3$. However, the original equation includes the term $b\sqrt[6]{x}$, and we cannot take the sixth root of a negative number, so this is not a solution. The only solution is $x = a^6$.

79. Let x be the number of people originally intended to take the trip. Then originally, the cost of the trip is $\frac{900}{x}$. After 5 people cancel, there are now $x - 5$ people, each paying $\frac{900}{x} + 2$. Thus $900 = (x - 5) \left(\frac{900}{x} + 2 \right) \Leftrightarrow 900 = 900 + 2x - \frac{4500}{x} - 10 \Leftrightarrow 0 = 2x - 10 - \frac{4500}{x} \Leftrightarrow 0 = 2x^2 - 10x - 4500 = (2x - 100)(x + 45)$. Thus either $2x - 100 = 0$, so $x = 50$, or $x + 45 = 0$, $x = -45$. Since the number of people on the trip must be positive, originally 50 people intended to take the trip.

80. Let n be the number of people in the group, so each person now pays $\frac{120,000}{n}$. If one person joins the group, then there would be $n + 1$ members in the group, and each person would pay $\frac{120,000}{n} - 6000$. So $(n + 1) \left(\frac{120,000}{n} - 6000 \right) = 120,000$
 $\Leftrightarrow \left[\left(\frac{n}{6000} \right) \left(\frac{120,000}{n} - 6000 \right) \right] (n + 1) = \left(\frac{n}{6000} \right) 120,000 \Leftrightarrow (20 - n)(n + 1) = 20n \Leftrightarrow -n^2 + 19n + 20 = 20n \Leftrightarrow$
 $0 = n^2 + n - 20 = (n - 4)(n + 5)$. Thus $n = 4$ or $n = -5$. Since n must be positive, there are now 4 friends in the group.
81. We want to solve for t when $P = 500$. Letting $u = \sqrt{t}$ and substituting, we have $500 = 3t + 10\sqrt{t} + 140 \Leftrightarrow$
 $500 = 3u^2 + 10u + 140 \Leftrightarrow 0 = 3u^2 + 10u - 360 \Leftrightarrow u = \frac{-5 \pm \sqrt{1105}}{3}$. Since $u = \sqrt{t}$, we must have $u \geq 0$. So
 $\sqrt{t} = u = \frac{-5 + \sqrt{1105}}{3} \approx 9.414 \Leftrightarrow t \approx 88.62$. So it will take 89 days for the fish population to reach 500.
82. Let d be the distance from the lens to the object. Then the distance from the lens to the image is $d - 4$. So substituting
 $F = 4.8$, $x = d$, and $y = d - 4$, and then solving for x , we have $\frac{1}{4.8} = \frac{1}{d} + \frac{1}{d - 4}$. Now we multiply by the
LCD, $4.8d(d - 4)$, to get $d(d - 4) = 4.8(d - 4) + 4.8d \Leftrightarrow d^2 - 4d = 9.6d - 19.2 \Leftrightarrow 0 = d^2 - 13.6d + 19.2 \Leftrightarrow$
 $d = \frac{13.6 \pm 10.4}{2}$. So $d = 1.6$ or $d = 12$. Since $d - 4$ must also be positive, the object is 12 cm from the lens.
83. Let x be the height of the pile in feet. Then the diameter is $3x$ and the radius is $\frac{3}{2}x$ feet. Since the volume of the cone is
 1000 ft^3 , we have $\frac{\pi}{3} \left(\frac{3x}{2} \right)^2 x = 1000 \Leftrightarrow \frac{3\pi x^3}{4} = 1000 \Leftrightarrow x^3 = \frac{4000}{3\pi} \Leftrightarrow x = \sqrt[3]{\frac{4000}{3\pi}} \approx 7.52$ feet.
84. Let r be the radius of the tank, in feet. The volume of the spherical tank is $\frac{4}{3}\pi r^3$ and is also $750 \times 0.1337 = 100.275$. So
 $\frac{4}{3}\pi r^3 = 100.275 \Leftrightarrow r^3 = 23.938 \Leftrightarrow r = 2.88$ feet.
85. Let r be the radius of the larger sphere, in mm. Equating the volumes, we have $\frac{4}{3}\pi r^3 = \frac{4}{3}\pi (2^3 + 3^3 + 4^3) \Leftrightarrow$
 $r^3 = 2^3 + 3^3 + 4^3 \Leftrightarrow r^3 = 99 \Leftrightarrow r = \sqrt[3]{99} \approx 4.63$. Therefore, the radius of the larger sphere is about 4.63 mm.
86. We have that the volume is 180 ft^3 , so $x(x - 4)(x + 9) = 180 \Leftrightarrow x^3 + 5x^2 - 36x = 180 \Leftrightarrow x^3 + 5x^2 - 36x - 180 = 0$
 $\Leftrightarrow x^2(x + 5) - 36(x + 5) = 0 \Leftrightarrow (x + 5)(x^2 - 36) = 0 \Leftrightarrow (x + 5)(x + 6)(x - 6) = 0 \Rightarrow x = 6$ is the only positive
solution. So the box is 2 feet by 6 feet by 15 feet.
87. Let x be the length, in miles, of the abandoned road to be used. Then the length of the abandoned road not used
is $40 - x$, and the length of the new road is $\sqrt{10^2 + (40 - x)^2}$ miles, by the Pythagorean Theorem. Since the
cost of the road is cost per mile \times number of miles, we have $100,000x + 200,000\sqrt{x^2 - 80x + 1700} = 6,800,000$
 $\Leftrightarrow 2\sqrt{x^2 - 80x + 1700} = 68 - x$. Squaring both sides, we get $4x^2 - 320x + 6800 = 4624 - 136x + x^2 \Leftrightarrow$
 $3x^2 - 184x + 2176 = 0 \Leftrightarrow x = \frac{184 \pm \sqrt{33856 - 26112}}{6} = \frac{184 \pm 88}{6} \Leftrightarrow x = \frac{136}{3}$ or $x = 16$. Since $45\frac{1}{3}$ is longer than the existing
road, 16 miles of the abandoned road should be used. A completely new road would have length $\sqrt{10^2 + 40^2}$ (let $x = 0$)
and would cost $\sqrt{1700} \times 200,000 \approx 8.3$ million dollars. So no, it would not be cheaper.

88. Let x be the distance, in feet, that he goes on the boardwalk before veering off onto the sand.

The distance along the boardwalk from where he started to the point on the boardwalk closest to the umbrella is $\sqrt{750^2 - 210^2} = 720$ ft. Thus the distance that he walks on the sand is

$$\sqrt{(720 - x)^2 + 210^2} = \sqrt{518,400 - 1440x + x^2 + 44,100} = \sqrt{x^2 - 1440x + 562,500}.$$

	Distance	Rate	Time
Along boardwalk	x	4	$\frac{x}{4}$
Across sand	$\sqrt{x^2 - 1440x + 562,500}$	2	$\frac{\sqrt{x^2 - 1440x + 562,500}}{2}$

Since 4 minutes 45 seconds = 285 seconds, we equate the time it takes to walk along the boardwalk and across the sand

$$\text{to the total time to get } 285 = \frac{x}{4} + \frac{\sqrt{x^2 - 1440x + 562,500}}{2} \Leftrightarrow 1140 - x = 2\sqrt{x^2 - 1440x + 562,500}.$$

Squaring both sides, we get $(1140 - x)^2 = 4(x^2 - 1440x + 562,500) \Leftrightarrow 1,299,600 - 2280x + x^2 = 4x^2 - 5760x + 2,250,000$

$$\Leftrightarrow 0 = 3x^2 - 3480x + 950,400 = 3(x^2 - 1160x + 316,800) = 3(x - 720)(x - 440). \text{ So } x - 720 = 0$$

$$\Leftrightarrow x = 720, \text{ and } x - 440 = 0 \Leftrightarrow x = 440. \text{ Checking } x = 720, \text{ the distance across the sand is}$$

$$210 \text{ feet. So } \frac{720}{4} + \frac{210}{2} = 180 + 105 = 285 \text{ seconds. Checking } x = 440, \text{ the distance across the sand is}$$

$\sqrt{(720 - 440)^2 + 210^2} = 350$ feet. So $\frac{440}{4} + \frac{350}{2} = 110 + 175 = 285$ seconds. Since both solutions are less than or equal to 720 feet, we have two solutions: he walks 440 feet down the boardwalk and then heads towards his umbrella, or he walks 720 feet down the boardwalk and then heads toward his umbrella.

89. Let x be the length of the hypotenuse of the triangle, in feet. Then one of the other sides has length $x - 7$ feet, and since the perimeter is 392 feet, the remaining side must have length $392 - x - (x - 7) = 399 - 2x$. From the Pythagorean Theorem, we get $(x - 7)^2 + (399 - 2x)^2 = x^2 \Leftrightarrow 4x^2 - 1610x + 159250 = 0$. Using the Quadratic Formula, we get

$x = \frac{1610 \pm \sqrt{1610^2 - 4(4)(159250)}}{2(4)} = \frac{1610 \pm \sqrt{44100}}{8} = \frac{1610 \pm 210}{8}$, and so $x = 227.5$ or $x = 175$. But if $x = 227.5$, then the side of length $x - 7$ combined with the hypotenuse already exceeds the perimeter of 392 feet, and so we must have $x = 175$. Thus the other sides have length $175 - 7 = 168$ and $399 - 2(175) = 49$. The lot has sides of length 49 feet, 168 feet, and 175 feet.

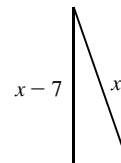

90. Let h be the height of the screens in inches. The width of the smaller screen is $h + 7$ inches, and the width of the bigger screen is $1.8h$ inches. The diagonal measure of the smaller screen is $\sqrt{h^2 + (h + 7)^2}$, and the diagonal measure of the larger screen is $\sqrt{h^2 + (1.8h)^2} = \sqrt{4.24h^2} \approx 2.06h$. Thus $\sqrt{h^2 + (h + 7)^2} + 3 = 2.06h \Leftrightarrow \sqrt{h^2 + (h + 7)^2} = 2.06h - 3$. Squaring both sides gives $h^2 + h^2 + 14h + 49 = 4.24h^2 - 12.36h + 9 \Leftrightarrow 0 = 2.24h^2 - 26.36h - 40$. Applying the Quadratic Formula, we obtain $h = \frac{26.36 \pm \sqrt{(-26.36)^2 - 4(2.24)(-40)}}{2(2.24)} = \frac{26.36 \pm \sqrt{1053.2496}}{4.48} \approx \frac{26.36 \pm 32.45}{4.48}$. So $h \approx \frac{26.36 \pm 32.45}{4.48} \approx 13.13$. Thus, the screens are approximately 13.1 inches high.

91. Since the total time is 3 s, we have $3 = \frac{\sqrt{d}}{4} + \frac{d}{1090}$. Letting $w = \sqrt{d}$, we have $3 = \frac{1}{4}w + \frac{1}{1090}w^2 \Leftrightarrow \frac{1}{1090}w^2 + \frac{1}{4}w - 3 = 0 \Leftrightarrow 2w^2 + 545w - 6540 = 0 \Leftrightarrow w = \frac{-545 \pm \sqrt{591.054}}{4}$. Since $w \geq 0$, we have $\sqrt{d} = w \approx 11.51$, so $d = 132.56$. The well is 132.6 ft deep.

92. (a) *Method 1:* Let $u = \sqrt{x}$, so $u^2 = x$. Thus $x - \sqrt{x} - 2 = 0$ becomes $u^2 - u - 2 = 0 \Leftrightarrow (u - 2)(u + 1) = 0$. So $u = 2$ or $u = -1$. If $u = 2$, then $\sqrt{x} = 2 \Rightarrow x = 4$. If $u = -1$, then $\sqrt{x} = -1 \Rightarrow x = 1$. So the possible solutions are 4 and 1. Checking $x = 4$ we have $4 - \sqrt{4} - 2 = 4 - 2 - 2 = 0$. Checking $x = 1$ we have $1 - \sqrt{1} - 2 = 1 - 1 - 2 \neq 0$. The only solution is 4.

Method 2: $x - \sqrt{x} - 2 = 0 \Leftrightarrow x - 2 = \sqrt{x} \Rightarrow x^2 - 4x + 4 = x \Leftrightarrow x^2 - 5x + 4 = 0 \Leftrightarrow (x - 4)(x - 1) = 0$. So the possible solutions are 4 and 1. Checking will result in the same solution.

- (b) *Method 1:* Let $u = \frac{1}{x-3}$, so $u^2 = \frac{1}{(x-3)^2}$. Thus $\frac{12}{(x-3)^2} + \frac{10}{x-3} + 1 = 0$ becomes $12u^2 + 10u + 1 = 0$. Using

the Quadratic Formula, we have $u = \frac{-10 \pm \sqrt{10^2 - 4(12)(1)}}{2(12)} = \frac{-10 \pm \sqrt{52}}{24} = \frac{-10 \pm 2\sqrt{13}}{24} = \frac{-5 \pm \sqrt{13}}{12}$. If $u = \frac{-5 - \sqrt{13}}{12}$,

then $\frac{1}{x-3} = \frac{-5 - \sqrt{13}}{12} \Leftrightarrow x - 3 = \frac{12}{-5 - \sqrt{13}} \cdot \frac{-5 + \sqrt{13}}{-5 + \sqrt{13}} = \frac{12(-5 + \sqrt{13})}{12} = -5 + \sqrt{13}$. So $x = -2 + \sqrt{13}$.

If $u = \frac{-5 + \sqrt{13}}{12}$, then $\frac{1}{x-3} = \frac{-5 + \sqrt{13}}{12} \Leftrightarrow x - 3 = \frac{12}{-5 + \sqrt{13}} \cdot \frac{-5 - \sqrt{13}}{-5 - \sqrt{13}} = \frac{12(-5 - \sqrt{13})}{12} = -5 - \sqrt{13}$. So $x = -2 - \sqrt{13}$.

The solutions are $-2 \pm \sqrt{13}$.

Method 2: Multiplying by the LCD, $(x-3)^2$, we get $(x-3)^2 \left(\frac{12}{(x-3)^2} + \frac{10}{x-3} + 1 \right) = 0 \cdot (x-3)^2 \Leftrightarrow$

$12 + 10(x-3) + (x-3)^2 = 0 \Leftrightarrow 12 + 10x - 30 + x^2 - 6x + 9 = 0 \Leftrightarrow x^2 + 4x - 9 = 0$. Using the Quadratic

Formula, we have $u = \frac{-4 \pm \sqrt{4^2 - 4(1)(-9)}}{2} = \frac{-4 \pm \sqrt{52}}{2} = \frac{-4 \pm 2\sqrt{13}}{2} = -2 \pm \sqrt{13}$. The solutions are $-2 \pm \sqrt{13}$.

1.7 SOLVING INEQUALITIES

1. (a) If $x < 5$, then $x - 3 < 5 - 3 \Rightarrow x - 3 < 2$.
- (b) If $x \leq 5$, then $3 \cdot x \leq 3 \cdot 5 \Rightarrow 3x \leq 15$.
- (c) If $x \geq 2$, then $-3 \cdot x \leq -3 \cdot 2 \Rightarrow -3x \leq -6$.
- (d) If $x < -2$, then $-x > 2$.

2. To solve the nonlinear inequality $\frac{x+1}{x-2} \leq 0$ we

first observe that the numbers -1 and 2 are zeros

of the numerator and denominator. These numbers divide the real line into the three intervals $(-\infty, -1)$, $(-1, 2)$, and $(2, \infty)$.

Interval	$(-\infty, -1)$	$(-1, 2)$	$(2, \infty)$
Sign of $x + 1$	-	+	+
Sign of $x - 2$	-	-	+
Sign of $(x + 1) / (x - 2)$	+	-	+

The endpoint -1 satisfies the inequality, because $\frac{-1+1}{-1-2} = 0 \leq 0$, but 2 fails to satisfy the inequality because $\frac{2+1}{2-2}$ is not defined.

Thus, referring to the table, we see that the solution of the inequality is $[-1, 2)$.

3. (a) No. For example, if $x = -2$, then $x(x+1) = -2(-1) = 2 > 0$.
- (b) No. For example, if $x = 2$, then $x(x+1) = 2(3) = 6$.
4. (a) To solve $3x \leq 7$, start by dividing both sides of the inequality by 3.
- (b) To solve $5x - 2 \geq 1$, start by adding 2 to both sides of the inequality.

5.

x	$-2 + 3x \geq \frac{1}{3}$
-5	$-17 \geq \frac{1}{3}$; no
-1	$-5 \geq \frac{1}{3}$; no
0	$-2 \geq 0$; no
$\frac{2}{3}$	$0 \geq \frac{1}{3}$; no
$\frac{5}{6}$	$\frac{1}{2} \geq \frac{1}{3}$; yes
1	$1 \geq \frac{1}{3}$; yes
$\sqrt{5}$	$4.7 \geq \frac{1}{3}$; yes
3	$7 \geq \frac{1}{3}$; yes
5	$13 \geq \frac{1}{3}$; yes

The elements $\frac{5}{6}$, 1, $\sqrt{5}$, 3, and 5 satisfy the inequality.

6.

x	$1 - 2x \geq 5x$
-5	$11 \geq -25$; yes
-1	$3 \geq -5$; yes
0	$1 \geq 0$; yes
$\frac{2}{3}$	$-\frac{1}{3} \geq \frac{10}{3}$; no
$\frac{5}{6}$	$-\frac{2}{3} \geq \frac{25}{6}$; no
1	$-1 \geq 5$; no
$\sqrt{5}$	$-3.47 \geq 11.18$; no
3	$-5 \geq 15$; no
5	$-9 \geq 25$; no

The elements -5, -1, and 0 satisfy the inequality.

7.

x	$1 < 2x - 4 \leq 7$
-5	$1 < -14 \leq 7$; no
-1	$1 < -6 \leq 7$; no
0	$1 < -4 \leq 7$; no
$\frac{2}{3}$	$1 < -\frac{8}{3} \leq 7$; no
$\frac{5}{6}$	$1 < -\frac{7}{3} \leq 7$; no
1	$1 < -2 \leq 7$; no
$\sqrt{5}$	$1 < 0.47 \leq 7$; no
3	$1 < 2 \leq 7$; yes
5	$1 < 6 \leq 7$; yes

The elements 3 and 5 satisfy the inequality.

8.

x	$-2 \leq 3 - x < 2$
-5	$-2 \leq 8 < 2$; no
-1	$-2 \leq 4 < 2$; no
0	$-2 \leq 3 < 2$; no
$\frac{2}{3}$	$-2 \leq \frac{7}{3} < 2$; no
$\frac{5}{6}$	$-2 < \frac{13}{6} < 2$; no
1	$-2 \leq 2 < 2$; no
$\sqrt{5}$	$-2 \leq 0.76 < 2$; yes
3	$-2 \leq 0 < 2$; yes
5	$-2 \leq -2 < 2$; yes

The elements $\sqrt{5}$, 3, and 5 satisfy the inequality.

9.

x	$\frac{1}{x} \leq \frac{1}{2}$
-5	$-\frac{1}{5} \leq \frac{1}{2}$; yes
-1	$-1 \leq \frac{1}{2}$; yes
0	$\frac{1}{0}$ is undefined; no
$\frac{2}{3}$	$\frac{3}{2} \leq \frac{1}{2}$; no
$\frac{5}{6}$	$\frac{6}{5} \leq \frac{1}{2}$; no
1	$1 \leq \frac{1}{2}$; no
$\sqrt{5}$	$0.45 \leq \frac{1}{2}$; yes
3	$\frac{1}{3} \leq \frac{1}{2}$; yes
5	$\frac{1}{5} \leq \frac{1}{2}$; yes

The elements -5, -1, $\sqrt{5}$, 3, and 5 satisfy the inequality.

10.

x	$x^2 + 2 < 4$
-5	$27 < 4$; no
-1	$3 < 4$; yes
0	$2 < 4$; yes
$\frac{2}{3}$	$\frac{22}{9} < 4$; yes
$\frac{5}{6}$	$\frac{97}{36} < 4$; yes
1	$3 < 4$; yes
$\sqrt{5}$	$7 < 4$; no
3	$11 < 4$; no
5	$27 < 4$; no

The elements -1, 0, $\frac{2}{3}$, $\frac{5}{6}$, and 1 satisfy the inequality.

11. $5x \leq 6 \Leftrightarrow x \leq \frac{6}{5}$. Interval: $(-\infty, \frac{6}{5}]$

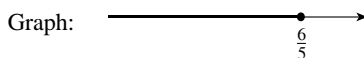

12. $2x \geq 8 \Leftrightarrow x \geq 4$. Interval: $[4, \infty)$

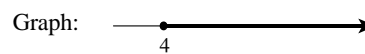

13. $2x - 5 > 3 \Leftrightarrow 2x > 8 \Leftrightarrow x > 4$

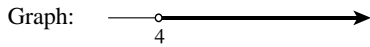
Interval: $(4, \infty)$ 

15. $2 - 3x > 8 \Leftrightarrow 3x < 2 - 8 \Leftrightarrow x < -2$

Interval: $(-\infty, -2)$ 

17. $2x + 1 < 0 \Leftrightarrow 2x < -1 \Leftrightarrow x < -\frac{1}{2}$

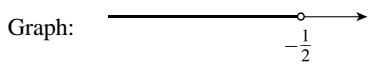
Interval: $(-\infty, -\frac{1}{2})$ 

19. $1 + 4x \leq 5 - 2x \Leftrightarrow 6x \leq 4 \Leftrightarrow x \leq \frac{2}{3}$

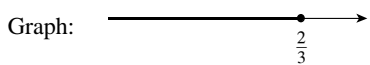
Interval: $(-\infty, \frac{2}{3}]$ 

21. $\frac{1}{2}x - \frac{2}{3} > 2 \Leftrightarrow \frac{1}{2}x > \frac{8}{3} \Leftrightarrow x > \frac{16}{3}$

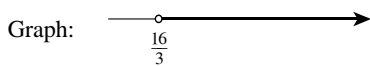
Interval: $(\frac{16}{3}, \infty)$ 

23. $4 - 3x \leq -(1 + 8x) \Leftrightarrow 4 - 3x \leq -1 - 8x \Leftrightarrow 5x \leq -5$
 $\Leftrightarrow x \leq -1$

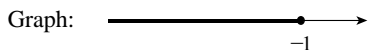
Interval: $(-\infty, -1]$ 

25. $2 \leq x + 5 < 4 \Leftrightarrow -3 \leq x < -1$

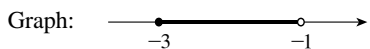
Interval: $[-3, -1)$ 

27. $-6 \leq 3x - 7 \leq 8 \Leftrightarrow 1 \leq 3x \leq 15 \Leftrightarrow \frac{1}{3} \leq x \leq 5$

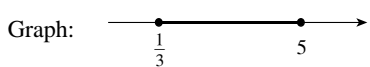
Interval: $[\frac{1}{3}, 5]$ 

14. $3x + 11 < 5 \Leftrightarrow 3x < -6 \Leftrightarrow x < -2$

Interval: $(-\infty, -2)$ 

16. $1 < 5 - 2x \Leftrightarrow 2x < 5 - 1 \Leftrightarrow x < 2$

Interval: $(-\infty, 2)$ 

18. $0 < 5 - 2x \Leftrightarrow 2x < 5 \Leftrightarrow x < \frac{5}{2}$

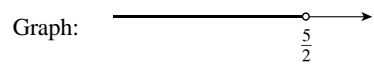
Interval: $(-\infty, \frac{5}{2})$ 

20. $5 - 3x \leq 2 - 9x \Leftrightarrow 6x \leq -3 \Leftrightarrow x \leq -\frac{1}{2}$

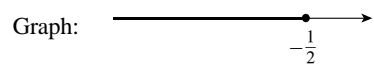
Interval: $(-\infty, -\frac{1}{2}]$ 

22. $\frac{2}{3} - \frac{1}{2}x \geq \frac{1}{6} + x$ (multiply both sides by 6) \Leftrightarrow

$4 - 3x \geq 1 + 6x \Leftrightarrow 3 \geq 9x \Leftrightarrow \frac{1}{3} \geq x$

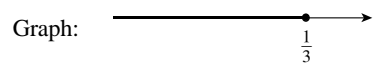
Interval: $(-\infty, \frac{1}{3}]$ 

24. $2(7x - 3) \leq 12x + 16 \Leftrightarrow 14x - 6 \leq 12x + 16 \Leftrightarrow$
 $2x \leq 22 \Leftrightarrow x \leq 11$

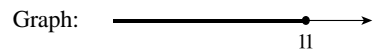
Interval: $(-\infty, 11]$ 

26. $5 \leq 3x - 4 \leq 14 \Leftrightarrow 9 \leq 3x \leq 18 \Leftrightarrow 3 \leq x \leq 6$

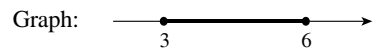
Interval: $[3, 6]$ 

28. $-8 \leq 5x - 4 \leq 5 \Leftrightarrow -4 \leq 5x \leq 9 \Leftrightarrow -\frac{4}{5} \leq x \leq \frac{9}{5}$

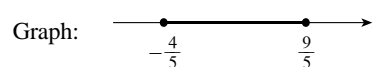
Interval: $[-\frac{4}{5}, \frac{9}{5}]$ 

$$29. -2 < 8 - 2x \leq -1 \Leftrightarrow -10 < -2x \leq -9 \Leftrightarrow 5 > x \geq \frac{9}{2}$$

$$\Leftrightarrow \frac{9}{2} \leq x < 5$$

$$\text{Interval: } \left[\frac{9}{2}, 5 \right)$$

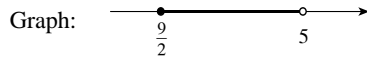

$$30. -3 \leq 3x + 7 \leq \frac{1}{2} \Leftrightarrow -10 \leq 3x \leq -\frac{13}{2} \Leftrightarrow$$

$$-\frac{10}{3} \leq x \leq -\frac{13}{6}$$

$$\text{Interval: } \left[-\frac{10}{3}, -\frac{13}{6} \right]$$

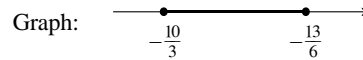

$$31. \frac{2}{3} \geq \frac{2x-3}{12} > \frac{1}{6} \Leftrightarrow 8 \geq 2x-3 > 2 \text{ (multiply each}$$

$$\text{expression by 12)} \Leftrightarrow 11 \geq 2x > 5 \Leftrightarrow \frac{11}{2} \geq x > \frac{5}{2}$$

$$\text{Interval: } \left(\frac{5}{2}, \frac{11}{2} \right]$$

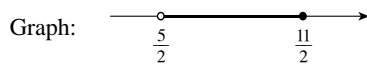

$$32. -\frac{1}{2} \leq \frac{4-3x}{5} \leq \frac{1}{4} \Leftrightarrow \text{(multiply each expression by 20)}$$

$$-10 \leq 4(4-3x) \leq 5 \Leftrightarrow -10 \leq 16-12x \leq 5 \Leftrightarrow$$

$$-26 \leq -12x \leq -11 \Leftrightarrow \frac{13}{6} \geq x \geq \frac{11}{12} \Leftrightarrow \frac{11}{12} \leq x \leq \frac{13}{6}$$

$$\text{Interval: } \left[\frac{11}{12}, \frac{13}{6} \right]$$

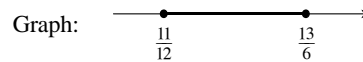

33. $(x+2)(x-3) < 0$. The expression on the left of the inequality changes sign where $x = -2$ and where $x = 3$. Thus we must check the intervals in the following table.

Interval	$(-\infty, -2)$	$(-2, 3)$	$(3, \infty)$
Sign of $x+2$	-	+	+
Sign of $x-3$	-	-	+
Sign of $(x+2)(x-3)$	+	-	+

From the table, the solution set is $\{x \mid -2 < x < 3\}$. Interval: $(-2, 3)$.

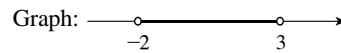

34. $(x-5)(x+4) \geq 0$. The expression on the left of the inequality changes sign when $x = 5$ and $x = -4$. Thus we must check the intervals in the following table.

Interval	$(-\infty, -4)$	$(-4, 5)$	$(5, \infty)$
Sign of $x-5$	-	-	+
Sign of $x+4$	-	+	+
Sign of $(x-5)(x+4)$	+	-	+

From the table, the solution set is $\{x \mid x \leq -4 \text{ or } 5 \leq x\}$.

Interval: $(-\infty, -4] \cup [5, \infty)$.

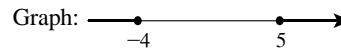

35. $x(2x+7) \geq 0$. The expression on the left of the inequality changes sign where $x = 0$ and where $x = -\frac{7}{2}$. Thus we must check the intervals in the following table.

Interval	$(-\infty, -\frac{7}{2})$	$(-\frac{7}{2}, 0)$	$(0, \infty)$
Sign of x	-	-	+
Sign of $2x+7$	-	+	+
Sign of $x(2x+7)$	+	-	+

From the table, the solution set is

$\{x \mid x \leq -\frac{7}{2} \text{ or } 0 \leq x\}$.

Interval: $(-\infty, -\frac{7}{2}] \cup [0, \infty)$.

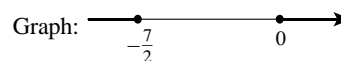

36. $x(2 - 3x) \leq 0$. The expression on the left of the inequality changes sign when $x = 0$ and $x = \frac{2}{3}$. Thus we must check the intervals in the following table.

Interval	$(-\infty, 0)$	$(0, \frac{2}{3})$	$(\frac{2}{3}, \infty)$
Sign of x	-	+	+
Sign of $2 - 3x$	+	+	-
Sign of $x(2 - 3x)$	-	+	-

From the table, the solution set is

$$\{x \mid x \leq 0 \text{ or } \frac{2}{3} \leq x\}.$$

Interval: $(-\infty, 0] \cup [\frac{2}{3}, \infty)$.



37. $x^2 - 3x - 18 \leq 0 \Leftrightarrow (x + 3)(x - 6) \leq 0$. The expression on the left of the inequality changes sign where $x = 6$ and where $x = -3$. Thus we must check the intervals in the following table.

Interval	$(-\infty, -3)$	$(-3, 6)$	$(6, \infty)$
Sign of $x + 3$	-	+	+
Sign of $x - 6$	-	-	+
Sign of $(x + 3)(x - 6)$	+	-	+

From the table, the solution set is

$$\{x \mid -3 \leq x \leq 6\}.$$

Interval: $[-3, 6]$.

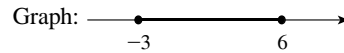

38. $x^2 + 5x + 6 > 0 \Leftrightarrow (x + 3)(x + 2) > 0$. The expression on the left of the inequality changes sign when $x = -3$ and $x = -2$. Thus we must check the intervals in the following table.

Interval	$(-\infty, -3)$	$(-3, -2)$	$(-2, \infty)$
Sign of $x + 3$	-	+	+
Sign of $x + 2$	-	-	+
Sign of $(x + 3)(x + 2)$	+	-	+

From the table, the solution set is

$$\{x \mid x < -3 \text{ or } -2 < x\}.$$

Interval: $(-\infty, -3) \cup (-2, \infty)$.

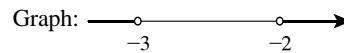

39. $2x^2 + x \geq 1 \Leftrightarrow 2x^2 + x - 1 \geq 0 \Leftrightarrow (x + 1)(2x - 1) \geq 0$. The expression on the left of the inequality changes sign where $x = -1$ and where $x = \frac{1}{2}$. Thus we must check the intervals in the following table.

Interval	$(-\infty, -1)$	$(-1, \frac{1}{2})$	$(\frac{1}{2}, \infty)$
Sign of $x + 1$	-	+	+
Sign of $2x - 1$	-	-	+
Sign of $(x + 1)(2x - 1)$	+	-	+

From the table, the solution set is

$$\{x \mid x \leq -1 \text{ or } \frac{1}{2} \leq x\}.$$

Interval: $(-\infty, -1] \cup [\frac{1}{2}, \infty)$.

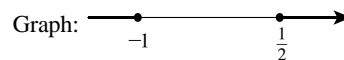

40. $x^2 < x + 2 \Leftrightarrow x^2 - x - 2 < 0 \Leftrightarrow (x + 1)(x - 2) < 0$. The expression on the left of the inequality changes sign when $x = -1$ and $x = 2$. Thus we must check the intervals in the following table.

Interval	$(-\infty, -1)$	$(-1, 2)$	$(2, \infty)$
Sign of $x + 1$	-	+	+
Sign of $x - 2$	-	-	+
Sign of $(x + 1)(x - 2)$	+	-	+

From the table, the solution set is

$$\{x \mid -1 < x < 2\}.$$

Interval: $(-1, 2)$.



41. $3x^2 - 3x < 2x^2 + 4 \Leftrightarrow x^2 - 3x - 4 < 0 \Leftrightarrow (x + 1)(x - 4) < 0$. The expression on the left of the inequality changes sign where $x = -1$ and where $x = 4$. Thus we must check the intervals in the following table.

Interval	$(-\infty, -1)$	$(-1, 4)$	$(4, \infty)$
Sign of $x + 1$	-	+	+
Sign of $x - 4$	-	-	+
Sign of $(x + 1)(x - 4)$	+	-	+

From the table, the solution set is $\{x \mid -1 < x < 4\}$. Interval: $(-1, 4)$.

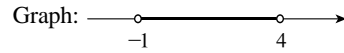

42. $5x^2 + 3x \geq 3x^2 + 2 \Leftrightarrow 2x^2 + 3x - 2 \geq 0 \Leftrightarrow (2x - 1)(x + 2) \geq 0$. The expression on the left of the inequality changes sign when $x = \frac{1}{2}$ and $x = -2$. Thus we must check the intervals in the following table.

Interval	$(-\infty, -2)$	$(-2, \frac{1}{2})$	$(\frac{1}{2}, \infty)$
Sign of $2x - 1$	-	-	+
Sign of $x + 2$	-	+	+
Sign of $(2x - 1)(x + 2)$	+	-	+

From the table, the solution set is $\{x \mid x \leq -2 \text{ or } \frac{1}{2} \leq x\}$.

Interval: $(-\infty, -2] \cup [\frac{1}{2}, \infty)$.

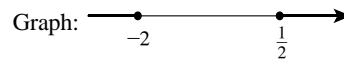

43. $x^2 > 3(x + 6) \Leftrightarrow x^2 - 3x - 18 > 0 \Leftrightarrow (x + 3)(x - 6) > 0$. The expression on the left of the inequality changes sign where $x = 6$ and where $x = -3$. Thus we must check the intervals in the following table.

Interval	$(-\infty, -3)$	$(-3, 6)$	$(6, \infty)$
Sign of $x + 3$	-	+	+
Sign of $x - 6$	-	-	+
Sign of $(x + 3)(x - 6)$	+	-	+

From the table, the solution set is $\{x \mid x < -3 \text{ or } 6 < x\}$.

Interval: $(-\infty, -3) \cup (6, \infty)$.

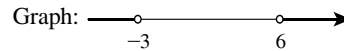

44. $x^2 + 2x > 3 \Leftrightarrow x^2 + 2x - 3 > 0 \Leftrightarrow (x + 3)(x - 1) > 0$. The expression on the left of the inequality changes sign when $x = -3$ and $x = 1$. Thus we must check the intervals in the following table.

Interval	$(-\infty, -3)$	$(-3, 1)$	$(1, \infty)$
Sign of $x + 3$	-	+	+
Sign of $x - 1$	-	-	+
Sign of $(x + 3)(x - 1)$	+	-	+

From the table, the solution set is $\{x \mid x < -3 \text{ or } 1 < x\}$.

Interval: $(-\infty, -3) \cup (1, \infty)$.

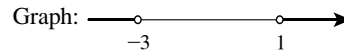

45. $x^2 < 4 \Leftrightarrow x^2 - 4 < 0 \Leftrightarrow (x + 2)(x - 2) < 0$. The expression on the left of the inequality changes sign where $x = -2$ and where $x = 2$. Thus we must check the intervals in the following table.

Interval	$(-\infty, -2)$	$(-2, 2)$	$(2, \infty)$
Sign of $x + 2$	-	+	+
Sign of $x - 2$	-	-	+
Sign of $(x + 2)(x - 2)$	+	-	+

From the table, the solution set is $\{x \mid -2 < x < 2\}$. Interval: $(-2, 2)$.

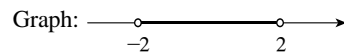

46. $x^2 \geq 9 \Leftrightarrow x^2 - 9 \geq 0 \Leftrightarrow (x + 3)(x - 3) \geq 0$. The expression on the left of the inequality changes sign when $x = -3$ and $x = 3$. Thus we must check the intervals in the following table.

Interval	$(-\infty, -3)$	$(-3, 3)$	$(3, \infty)$
Sign of $x + 3$	-	+	+
Sign of $x - 3$	-	-	+
Sign of $(x + 3)(x - 3)$	+	-	+

From the table, the solution set is $\{x \mid x \leq -3 \text{ or } 3 \leq x\}$.

Interval: $(-\infty, -3] \cup [3, \infty)$.

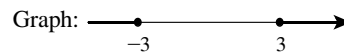

47. $(x + 2)(x - 1)(x - 3) \leq 0$. The expression on the left of the inequality changes sign when $x = -2$, $x = 1$, and $x = 3$. Thus we must check the intervals in the following table.

Interval	$(-\infty, -2)$	$(-2, 1)$	$(1, 3)$	$(3, \infty)$
Sign of $x + 2$	-	+	+	+
Sign of $x - 1$	-	-	+	+
Sign of $x - 3$	-	-	-	+
Sign of $(x + 2)(x - 1)(x - 3)$	-	+	-	+

From the table, the solution set is $\{x \mid x \leq -2 \text{ or } 1 \leq x \leq 3\}$. Interval: $(-\infty, -2] \cup [1, 3]$. Graph:

48. $(x - 5)(x - 2)(x + 1) > 0$. The expression on the left of the inequality changes sign when $x = 5$, $x = 2$, and $x = -1$. Thus we must check the intervals in the following table.

Interval	$(-\infty, -1)$	$(-1, 2)$	$(2, 5)$	$(5, \infty)$
Sign of $x - 5$	-	-	-	+
Sign of $x - 2$	-	-	+	+
Sign of $x + 1$	-	+	+	+
Sign of $(x - 5)(x - 2)(x + 1)$	-	+	-	+

From the table, the solution set is $\{x \mid -1 < x < 2 \text{ or } 5 < x\}$. Interval: $(-1, 2) \cup (5, \infty)$. Graph:

49. $(x - 4)(x + 2)^2 < 0$. Note that $(x + 2)^2 > 0$ for all $x \neq -2$, so the expression on the left of the original inequality changes sign only when $x = 4$. We check the intervals in the following table.

Interval	$(-\infty, -2)$	$(-2, 4)$	$(4, \infty)$
Sign of $x - 4$	-	-	+
Sign of $(x + 2)^2$	+	+	+
Sign of $(x - 4)(x + 2)^2$	-	-	+

From the table, the solution set is $\{x \mid x \neq -2 \text{ and } x < 4\}$. We exclude the endpoint -2 since the original expression cannot be 0. Interval: $(-\infty, -2) \cup (-2, 4)$.

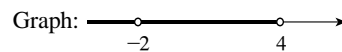

50. $(x + 3)^2(x + 1) > 0$. Note that $(x + 3)^2 > 0$ for all $x \neq -3$, so the expression on the left of the original inequality changes sign only when $x = -1$. We check the intervals in the following table.

Interval	$(-\infty, -3)$	$(-3, -1)$	$(-1, \infty)$
Sign of $(x + 3)^2$	+	+	+
Sign of $x + 1$	-	-	+
Sign of $(x + 3)^2(x + 1)$	-	-	+

From the table, the solution set is $\{x \mid x > -1\}$.
(The endpoint -3 is already excluded.)

Interval: $(-1, \infty)$.

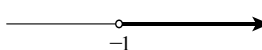
Graph: 

51. $(x - 2)^2(x - 3)(x + 1) \leq 0$. Note that $(x - 2)^2 \geq 0$ for all x , so the expression on the left of the original inequality changes sign only when $x = -1$ and $x = 3$. We check the intervals in the following table.

Interval	$(-\infty, -1)$	$(-1, 2)$	$(2, 3)$	$(3, \infty)$
Sign of $(x - 2)^2$	+	+	+	+
Sign of $x - 3$	-	-	-	+
Sign of $x + 1$	-	+	+	+
Sign of $(x - 2)^2(x - 3)(x + 1)$	+	-	-	+

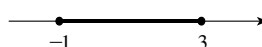
From the table, the solution set is $\{x \mid -1 \leq x \leq 3\}$. Interval: $[-1, 3]$. Graph: 

52. $x^2(x^2 - 1) \geq 0 \Leftrightarrow x^2(x + 1)(x - 1) \geq 0$. The expression on the left of the inequality changes sign when $x = \pm 1$ and $x = 0$. Thus we must check the intervals in the following table.

Interval	$(-\infty, -1)$	$(-1, 0)$	$(0, 1)$	$(1, \infty)$
Sign of x^2	+	+	+	+
Sign of $x + 1$	-	+	+	+
Sign of $x - 1$	-	-	-	+
Sign of $x^2(x^2 - 1)$	+	-	-	+

From the table, the solution set is $\{x \mid x \leq -1, x = 0, \text{ or } 1 \leq x\}$. (The endpoint 0 is included since the original expression is allowed to be 0.) Interval: $(-\infty, -1] \cup \{0\} \cup [1, \infty)$. Graph: 

53. $x^3 - 4x > 0 \Leftrightarrow x(x^2 - 4) > 0 \Leftrightarrow x(x + 2)(x - 2) > 0$. The expression on the left of the inequality changes sign where $x = 0$, $x = -2$ and where $x = 4$. Thus we must check the intervals in the following table.

Interval	$(-\infty, -2)$	$(-2, 0)$	$(0, 2)$	$(2, \infty)$
Sign of x	-	-	+	+
Sign of $x + 2$	-	+	+	+
Sign of $x - 2$	-	-	-	+
Sign of $x(x + 2)(x - 2)$	-	+	-	+

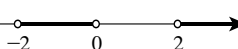
From the table, the solution set is $\{x \mid -2 < x < 0 \text{ or } x > 2\}$. Interval: $(-2, 0) \cup (2, \infty)$. Graph: 

54. $16x \leq x^3 \Leftrightarrow 0 \leq x^3 - 16x = x(x^2 - 16) = x(x - 4)(x + 4)$. The expression on the left of the inequality changes sign when $x = -4$, $x = 0$, and $x = 4$. Thus we must check the intervals in the following table.

Interval	$(-\infty, -4)$	$(-4, 0)$	$(0, 4)$	$(4, \infty)$
Sign of $x + 4$	-	+	+	+
Sign of x	-	-	+	+
Sign of $x - 4$	-	-	-	+
Sign of $x(x + 4)(x - 4)$	-	+	-	+

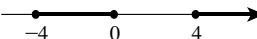
From the table, the solution set is $\{x \mid -4 \leq x \leq 0 \text{ or } 4 \leq x\}$. Interval: $[-4, 0] \cup [4, \infty)$. Graph: 

55. $\frac{x + 3}{2x - 1} \geq 0$. The expression on the left of the inequality changes sign where $x = -3$ and where $x = \frac{1}{2}$. Thus we must check the intervals in the following table.

Interval	$(-\infty, -3)$	$(-3, \frac{1}{2})$	$(\frac{1}{2}, \infty)$
Sign of $x + 3$	-	+	+
Sign of $2x - 1$	-	-	+
Sign of $\frac{x + 3}{2x - 1}$	+	-	+

From the table, the solution set is

$\{x \mid x < -3 \text{ or } x > \frac{1}{2}\}$. Since the denominator cannot equal 0, $x \neq \frac{1}{2}$.

Interval: $(-\infty, -3] \cup (\frac{1}{2}, \infty)$.

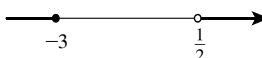
Graph: 

56. $\frac{4 - x}{x + 4} < 0$. The expression on the left of the inequality changes sign when $x = -4$ and $x = 4$. Thus we must check the intervals in the following table.

Interval	$(-\infty, -4)$	$(-4, 4)$	$(4, \infty)$
Sign of $4 - x$	+	+	-
Sign of $x + 4$	-	+	+
Sign of $\frac{4 - x}{x + 4}$	-	+	-

From the table, the solution set is

$\{x \mid x < -4 \text{ or } x > 4\}$.

Interval: $(-\infty, -4) \cup (4, \infty)$.

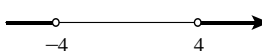
Graph: 

57. $\frac{4 - x}{x + 4} < 0$. The expression on the left of the inequality changes sign where $x = \pm 4$. Thus we must check the intervals in the following table.

Interval	$(-\infty, -4)$	$(-4, 4)$	$(4, \infty)$
Sign of $4 - x$	+	+	-
Sign of $x + 4$	-	+	+
Sign of $\frac{4 - x}{x + 4}$	-	+	-

From the table, the solution set is

$\{x \mid x < -4 \text{ or } x > 4\}$.

Interval: $(-\infty, -4) \cup (4, \infty)$.

Graph: 

58. $-2 < \frac{x+1}{x-3} \Leftrightarrow 0 < \frac{x+1}{x-3} + 2 \Leftrightarrow 0 < \frac{x+1}{x-3} + \frac{2(x-3)}{x-3} \Leftrightarrow 0 < \frac{3x-5}{x-3}$. The expression on the left of the inequality changes sign when $x = \frac{5}{3}$ and $x = 3$. Thus we must check the intervals in the following table.

Interval	$(-\infty, \frac{5}{3})$	$(\frac{5}{3}, 3)$	$(3, \infty)$
Sign of $3x - 5$	-	+	+
Sign of $x - 3$	-	-	+
Sign of $\frac{3x-5}{x-3}$	+	-	+

From the table, the solution set is

$$\{x \mid x < \frac{5}{3} \text{ or } 3 < x < \infty\}.$$

$$\text{Interval: } (-\infty, \frac{5}{3}) \cup (3, \infty).$$

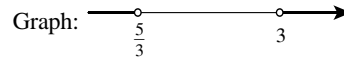

59. $\frac{2x+1}{x-5} \leq 3 \Leftrightarrow \frac{2x+1}{x-5} - 3 \leq 0 \Leftrightarrow \frac{2x+1}{x-5} - \frac{3(x-5)}{x-5} \leq 0 \Leftrightarrow \frac{-x+16}{x-5} \leq 0$. The expression on the left of the inequality changes sign where $x = 16$ and where $x = 5$. Thus we must check the intervals in the following table.

Interval	$(-\infty, 5)$	$(5, 16)$	$(16, \infty)$
Sign of $-x + 16$	+	+	-
Sign of $x - 5$	-	+	+
Sign of $\frac{-x+16}{x-5}$	-	+	-

From the table, the solution set is

$\{x \mid x < 5 \text{ or } x \geq 16\}$. Since the denominator cannot equal 0, we must have $x \neq 5$.

$$\text{Interval: } (-\infty, 5) \cup [16, \infty).$$

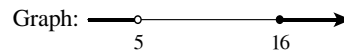

60. $\frac{3+x}{3-x} \geq 1 \Leftrightarrow \frac{3+x}{3-x} - 1 \geq 0 \Leftrightarrow \frac{3+x}{3-x} - \frac{3-x}{3-x} \geq 0 \Leftrightarrow \frac{2x}{3-x} \geq 0$. The expression on the left of the inequality changes sign when $x = 0$ and $x = 3$. Thus we must check the intervals in the following table.

Interval	$(-\infty, 0)$	$(0, 3)$	$(3, \infty)$
Sign of $3 - x$	+	+	-
Sign of $2x$	-	+	+
Sign of $\frac{2x}{3-x}$	-	+	-

Since the denominator cannot equal 0, we must have $x \neq 3$. The solution set is $\{x \mid 0 \leq x < 3\}$.

$$\text{Interval: } [0, 3).$$

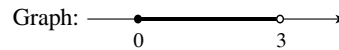

61. $\frac{4}{x} < x \Leftrightarrow \frac{4}{x} - x < 0 \Leftrightarrow \frac{4}{x} - \frac{x \cdot x}{x} < 0 \Leftrightarrow \frac{4-x^2}{x} < 0 \Leftrightarrow \frac{(2-x)(2+x)}{x} < 0$. The expression on the left of the inequality changes sign where $x = 0$, where $x = -2$, and where $x = 2$. Thus we must check the intervals in the following table.

Interval	$(-\infty, -2)$	$(-2, 0)$	$(0, 2)$	$(2, \infty)$
Sign of $2 + x$	-	+	+	+
Sign of x	-	-	+	+
Sign of $2 - x$	+	+	+	-
Sign of $\frac{(2-x)(2+x)}{x}$	+	-	+	-

From the table, the solution set is $\{x \mid -2 < x < 0 \text{ or } 2 < x\}$. Interval: $(-2, 0) \cup (2, \infty)$. Graph:

62. $\frac{x}{x+1} > 3x \Leftrightarrow \frac{x}{x+1} - 3x > 0 \Leftrightarrow \frac{x}{x+1} - \frac{3x(x+1)}{x+1} > 0 \Leftrightarrow \frac{-2x-3x^2}{x+1} > 0 \Leftrightarrow \frac{-x(2+3x)}{x+1} > 0$. The expression on the left of the inequality changes sign when $x = 0$, $x = -\frac{2}{3}$, and $x = -1$. Thus we must check the intervals in the following table.

Interval	$(-\infty, -1)$	$(-1, -\frac{2}{3})$	$(-\frac{2}{3}, 0)$	$(0, \infty)$
Sign of $-x$	+	+	+	-
Sign of $2+3x$	-	-	+	+
Sign of $x+1$	-	+	+	+
Sign of $\frac{(2-x)(2+x)}{x}$	+	-	+	-

From the table, the solution set is $\{x \mid x < -1 \text{ or } -\frac{2}{3} < x < 0\}$. Interval: $(-\infty, -1) \cup (-\frac{2}{3}, 0)$.

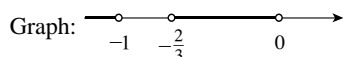

63. $1 + \frac{2}{x+1} \leq \frac{2}{x} \Leftrightarrow 1 + \frac{2}{x+1} - \frac{2}{x} \leq 0 \Leftrightarrow \frac{x(x+1)}{x(x+1)} + \frac{2x}{x(x+1)} - \frac{2(x+1)}{x(x+1)} \leq 0 \Leftrightarrow \frac{x^2+x+2x-2x-2}{x(x+1)} \leq 0 \Leftrightarrow \frac{x^2+x-2}{x(x+1)} \leq 0 \Leftrightarrow \frac{(x+2)(x-1)}{x(x+1)} \leq 0$. The expression on the left of the inequality changes sign where $x = -2$, where $x = -1$, where $x = 0$, and where $x = 1$. Thus we must check the intervals in the following table.

Interval	$(-\infty, -2)$	$(-2, -1)$	$(-1, 0)$	$(0, 1)$	$(1, \infty)$
Sign of $x+2$	-	+	+	+	+
Sign of $x-1$	-	-	-	-	+
Sign of x	-	-	-	+	+
Sign of $x+1$	-	-	+	+	+
Sign of $\frac{(x+2)(x-1)}{x(x+1)}$	+	-	+	-	+

Since $x = -1$ and $x = 0$ yield undefined expressions, we cannot include them in the solution. From the table, the solution

set is $\{x \mid -2 \leq x < -1 \text{ or } 0 < x \leq 1\}$. Interval: $[-2, -1) \cup (0, 1]$. Graph:

$$64. \frac{3}{x-1} - \frac{4}{x} \geq 1 \Leftrightarrow \frac{3}{x-1} - \frac{4}{x} - 1 \geq 0 \Leftrightarrow \frac{3x}{x(x-1)} - \frac{4(x-1)}{x(x-1)} - \frac{x(x-1)}{x(x-1)} \geq 0 \Leftrightarrow \frac{3x - 4x + 4 - x^2 + x}{x(x-1)} \geq 0 \Leftrightarrow$$

$$\frac{4 - x^2}{x(x-1)} \geq 0 \Leftrightarrow \frac{(2-x)(2+x)}{x(x-1)} \geq 0. \text{ The expression on the left of the inequality changes sign when } x = 2, x = -2,$$

$x = 0$, and $x = 1$. Thus we must check the intervals in the following table.

Interval	$(-\infty, -2)$	$(-2, 0)$	$(0, 1)$	$(1, 2)$	$(2, \infty)$
Sign of $2 - x$	+	+	+	+	-
Sign of $2 + x$	-	+	+	+	+
Sign of x	-	-	+	+	+
Sign of $x - 1$	-	-	-	+	+
Sign of $\frac{(2-x)(2+x)}{x(x-1)}$	-	+	-	+	-

Since $x = 0$ and $x = 1$ give undefined expressions, we cannot include them in the solution. From the table, the solution set

is $\{x \mid -2 \leq x < 0 \text{ or } 1 < x \leq 2\}$. Interval: $[-2, 0) \cup (1, 2]$. Graph:

$$65. \frac{6}{x-1} - \frac{6}{x} \geq 1 \Leftrightarrow \frac{6}{x-1} - \frac{6}{x} - 1 \geq 0 \Leftrightarrow \frac{6x}{x(x-1)} - \frac{6(x-1)}{x(x-1)} - \frac{x(x-1)}{x(x-1)} \geq 0 \Leftrightarrow$$

$$\frac{6x - 6x + 6 - x^2 + x}{x(x-1)} \geq 0 \Leftrightarrow \frac{-x^2 + x + 6}{x(x-1)} \geq 0 \Leftrightarrow \frac{(-x+3)(x+2)}{x(x-1)} \geq 0. \text{ The}$$

expression on the left of the inequality changes sign where $x = 3$, where $x = -2$, where $x = 0$, and where $x = 1$. Thus we must check the intervals in the following table.

Interval	$(-\infty, -2)$	$(-2, 0)$	$(0, 1)$	$(1, 3)$	$(3, \infty)$
Sign of $-x + 3$	+	+	+	+	-
Sign of $x + 2$	-	+	+	+	+
Sign of x	-	-	+	+	+
Sign of $x - 1$	-	-	-	+	+
Sign of $\frac{(-x+3)(x+2)}{x(x-1)}$	-	+	-	+	-

From the table, the solution set is $\{x \mid -2 \leq x < 0 \text{ or } 1 < x \leq 3\}$. The points $x = 0$ and $x = 1$ are excluded from the

solution set because they make the denominator zero. Interval: $[-2, 0) \cup (1, 3]$. Graph:

$$66. \frac{x}{2} \geq \frac{5}{x+1} + 4 \Leftrightarrow \frac{x}{2} - \frac{5}{x+1} - 4 \geq 0 \Leftrightarrow \frac{x(x+1)}{2(x+1)} - \frac{2 \cdot 5}{2(x+1)} - \frac{4(2)(x+1)}{2(x+1)} \geq 0 \Leftrightarrow \frac{x^2 + x - 10 - 8x - 8}{2(x+1)} \geq 0 \Leftrightarrow$$

$$\frac{x^2 - 7x - 18}{2(x+1)} \geq 0 \Leftrightarrow \frac{(x-9)(x+2)}{2(x+1)} \geq 0. \text{ The expression on the left of the inequality changes sign when } x = 9, x = -2,$$

and $x = -1$. Thus we must check the intervals in the following table.

Interval	$(-\infty, -2)$	$(-2, -1)$	$(-1, 9)$	$(9, \infty)$
Sign of $x - 9$	-	-	-	+
Sign of $x + 2$	-	+	+	+
Sign of $x + 1$	-	-	+	+
Sign of $\frac{(x-9)(x+2)}{2(x+1)}$	-	+	-	+

From the table, the solution set is $\{x \mid -2 \leq x < -1 \text{ or } 9 \leq x\}$. The point $x = -1$ is excluded from the solution set because

it makes the expression undefined. Interval: $[-2, -1) \cup [9, \infty)$. Graph: 

$$67. \frac{x+2}{x+3} < \frac{x-1}{x-2} \Leftrightarrow \frac{x+2}{x+3} - \frac{x-1}{x-2} < 0 \Leftrightarrow \frac{(x+2)(x-2)}{(x+3)(x-2)} - \frac{(x-1)(x+3)}{(x-2)(x+3)} < 0 \Leftrightarrow$$

$$\frac{x^2 - 4 - x^2 - 2x + 3}{(x+3)(x-2)} < 0 \Leftrightarrow \frac{-2x - 1}{(x+3)(x-2)} < 0. \text{ The expression on the left of the inequality}$$

changes sign where $x = -\frac{1}{2}$, where $x = -3$, and where $x = 2$. Thus we must check the intervals in the following table.

Interval	$(-\infty, -3)$	$(-3, -\frac{1}{2})$	$(-\frac{1}{2}, 2)$	$(2, \infty)$
Sign of $-2x - 1$	+	+	-	-
Sign of $x + 3$	-	+	+	+
Sign of $x - 2$	-	-	-	+
Sign of $\frac{-2x - 1}{(x+3)(x-2)}$	+	-	+	-

From the table, the solution set is $\{x \mid -3 < x < -\frac{1}{2} \text{ or } 2 < x\}$. Interval: $(-3, -\frac{1}{2}) \cup (2, \infty)$.

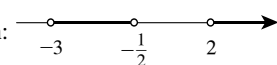
Graph: 

$$68. \frac{1}{x+1} + \frac{1}{x+2} \leq 0 \Leftrightarrow \frac{x+2}{(x+1)(x+2)} + \frac{x+1}{(x+1)(x+2)} \leq 0 \Leftrightarrow \frac{x+2+x+1}{(x+1)(x+2)} \leq 0 \Leftrightarrow \frac{2x+3}{(x+1)(x+2)} \leq 0. \text{ The}$$

expression on the left of the inequality changes sign when $x = -\frac{3}{2}$, $x = -1$, and $x = -2$. Thus we must check the intervals in the following table.

Interval	$(-\infty, -2)$	$(-2, -\frac{3}{2})$	$(-\frac{3}{2}, -1)$	$(-1, \infty)$
Sign of $2x + 3$	-	-	+	+
Sign of $x + 1$	-	-	-	+
Sign of $x + 2$	-	+	+	+
Sign of $\frac{2x+3}{(x+1)(x+2)}$	-	+	-	+

From the table, the solution set is $\{x \mid x < -2 \text{ or } -\frac{3}{2} \leq x < -1\}$. The points $x = -2$ and $x = -1$ are

excluded from the solution because the expression is undefined at those values. Interval: $(-\infty, -2) \cup [-\frac{3}{2}, -1)$.

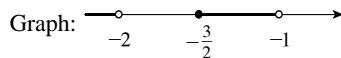

$$69. \frac{(x-1)(x+2)}{(x-2)^2} \geq 0. \text{ Note that } (x-2)^2 \geq 0 \text{ for all } x. \text{ The expression on the left of the original inequality changes sign}$$

when $x = -2$ and $x = 1$. We check the intervals in the following table.

Interval	$(-\infty, -2)$	$(-2, 1)$	$(1, 2)$	$(2, \infty)$
Sign of $x - 1$	-	-	+	+
Sign of $x + 2$	-	+	+	+
Sign of $(x - 2)^2$	+	+	+	+
Sign of $\frac{(x-1)(x+2)}{(x-2)^2}$	+	-	+	+

From the table, and recalling that the point $x = 2$ is excluded from the solution because the expression is undefined at those values, the solution set is $\{x \mid x \leq -2 \text{ or } x \geq 1 \text{ and } x \neq 2\}$. Interval: $(-\infty, -2] \cup [1, 2) \cup (2, \infty)$.



70. $\frac{(2x-1)(x-3)^2}{x-4} < 0$. Note that $(x-3)^2 > 0$ for all $x \neq 3$. The expression on the left of the inequality changes sign when $x = \frac{1}{2}$ and $x = 4$. We check the intervals in the following table.

Interval	$(-\infty, \frac{1}{2})$	$(\frac{1}{2}, 3)$	$(3, 4)$	$(4, \infty)$
Sign of $2x - 1$	-	+	+	+
Sign of $(x - 3)^2$	+	+	+	+
Sign of $x - 4$	-	-	-	+
Sign of $\frac{(2x-1)(x-3)^2}{x-4}$	+	-	-	+

From the table, the solution set is $\{x \mid x \neq 3 \text{ and } \frac{1}{2} < x < 4\}$. We exclude the endpoint 3 because the original expression

cannot be 0. Interval: $(\frac{1}{2}, 3) \cup (3, 4)$. Graph:

71. $x^4 > x^2 \Leftrightarrow x^4 - x^2 > 0 \Leftrightarrow x^2(x^2 - 1) > 0 \Leftrightarrow x^2(x-1)(x+1) > 0$. The expression on the left of the inequality changes sign where $x = 0$, where $x = 1$, and where $x = -1$. Thus we must check the intervals in the following table.

Interval	$(-\infty, -1)$	$(-1, 0)$	$(0, 1)$	$(1, \infty)$
Sign of x^2	+	+	+	+
Sign of $x - 1$	-	-	-	+
Sign of $x + 1$	-	+	+	+
Sign of $x^2(x-1)(x+1)$	+	-	-	+

From the table, the solution set is $\{x \mid x < -1 \text{ or } 1 < x\}$. Interval: $(-\infty, -1) \cup (1, \infty)$. Graph:

72. $x^5 > x^2 \Leftrightarrow x^5 - x^2 > 0 \Leftrightarrow x^2(x^3 - 1) > 0 \Leftrightarrow x^2(x-1)(x^2+x+1) > 0$. The expression on the left of the inequality changes sign when $x = 0$ and $x = 1$. But the solution of $x^2 + x + 1 = 0$ are $x = \frac{-1 \pm \sqrt{(1)^2 - 4(1)(1)}}{2(1)} = \frac{-1 \pm \sqrt{-3}}{2}$.

Since these are not real solutions. The expression $x^2 + x + 1$ does not change signs, so we must check the intervals in the following table.

Interval	$(-\infty, 0)$	$(0, 1)$	$(1, \infty)$
Sign of x^2	+	+	+
Sign of $x - 1$	-	-	+
Sign of $x^2 + x + 1$	+	+	+
Sign of $x^2(x-1)(x^2+x+1)$	-	-	+

From the table, the solution set is $\{x \mid 1 < x\}$. Interval: $(1, \infty)$. Graph:

73. For $\sqrt{16 - 9x^2}$ to be defined as a real number we must have $16 - 9x^2 \geq 0 \Leftrightarrow (4 - 3x)(4 + 3x) \geq 0$. The expression in the inequality changes sign at $x = \frac{4}{3}$ and $x = -\frac{4}{3}$.

Interval	$(-\infty, -\frac{4}{3})$	$(-\frac{4}{3}, \frac{4}{3})$	$(\frac{4}{3}, \infty)$
Sign of $4 - 3x$	+	+	-
Sign of $4 + 3x$	-	+	+
Sign of $(4 - 3x)(4 + 3x)$	-	+	-

Thus $-\frac{4}{3} \leq x \leq \frac{4}{3}$.

74. For $\sqrt{3x^2 - 5x + 2}$ to be defined as a real number, we must have $3x^2 - 5x + 2 \geq 0 \Leftrightarrow (3x - 2)(x - 1) \geq 0$. The expression on the left of the inequality changes sign when $x = \frac{2}{3}$ and $x = 1$. Thus we must check the intervals in the following table.

Interval	$(-\infty, \frac{2}{3})$	$(\frac{2}{3}, 1)$	$(1, \infty)$
Sign of $3x - 2$	-	+	+
Sign of $x - 1$	-	-	+
Sign of $(3x - 2)(x - 1)$	+	-	+

Thus $x \leq \frac{2}{3}$ or $1 \leq x$.

75. For $\left(\frac{1}{x^2 - 5x - 14}\right)^{1/2}$ to be defined as a real number we must have $x^2 - 5x - 14 > 0 \Leftrightarrow (x - 7)(x + 2) > 0$. The expression in the inequality changes sign at $x = 7$ and $x = -2$.

Interval	$(-\infty, -2)$	$(-2, 7)$	$(7, \infty)$
Sign of $x - 7$	-	-	+
Sign of $x + 2$	-	+	+
Sign of $(x - 7)(x + 2)$	+	-	+

Thus $x < -2$ or $7 < x$, and the solution set is $(-\infty, -2) \cup (7, \infty)$.

76. For $\sqrt[4]{\frac{1-x}{2+x}}$ to be defined as a real number we must have $\frac{1-x}{2+x} \geq 0$. The expression on the left of the inequality changes sign when $x = 1$ and $x = -2$. Thus we must check the intervals in the following table.

Interval	$(-\infty, -2)$	$(-2, 1)$	$(1, \infty)$
Sign of $1 - x$	+	+	-
Sign of $2 + x$	-	+	+
Sign of $\frac{1-x}{2+x}$	-	+	-

Thus $-2 < x \leq 1$. Note that $x = -2$ has been excluded from the solution set because the expression is undefined at that value.

77. $a(bx - c) \geq bc$ (where $a, b, c > 0$) $\Leftrightarrow bx - c \geq \frac{bc}{a} \Leftrightarrow bx \geq \frac{bc}{a} + c \Leftrightarrow x \geq \frac{1}{b} \left(\frac{bc}{a} + c \right) = \frac{c}{a} + \frac{c}{b} \Leftrightarrow x \geq \frac{c}{a} + \frac{c}{b}$.

78. We have $a \leq bx + c < 2a$, where $a, b, c > 0 \Leftrightarrow a - c \leq bx < 2a - c \Leftrightarrow \frac{a-c}{b} \leq x < \frac{2a-c}{b}$.

79. Inserting the relationship $C = \frac{5}{9}(F - 32)$, we have $20 \leq C \leq 30 \Leftrightarrow 20 \leq \frac{5}{9}(F - 32) \leq 30 \Leftrightarrow 36 \leq F - 32 \leq 54 \Leftrightarrow 68 \leq F \leq 86$.
80. Inserting the relationship $F = \frac{9}{5}C + 32$, we have $50 \leq F \leq 95 \Leftrightarrow 50 \leq \frac{9}{5}C + 32 \leq 95 \Leftrightarrow 18 \leq \frac{9}{5}C \leq 63 \Leftrightarrow 10 \leq C \leq 35$.
81. Let x be the average number of miles driven per day. Each day the cost of Plan A is $30 + 0.10x$, and the cost of Plan B is 50. Plan B saves money when $50 < 30 + 0.10x \Leftrightarrow 20 < 0.1x \Leftrightarrow 200 < x$. So Plan B saves money when you average more than 200 miles a day.
82. Let m be the number of minutes of long-distance calls placed per month. Then under Plan A, the cost will be $25 + 0.05m$, and under Plan B, the cost will be $5 + 0.12m$. To determine when Plan B is advantageous, we must solve $25 + 0.05m > 5 + 0.12m \Leftrightarrow 20 > 0.07m \Leftrightarrow 285.7 > m$. So Plan B is advantageous if a person places fewer than 286 minutes of long-distance calls during a month.
83. We need to solve $6400 \leq 0.35m + 2200 \leq 7100$ for m . So $6400 \leq 0.35m + 2200 \leq 7100 \Leftrightarrow 4200 \leq 0.35m \leq 4900 \Leftrightarrow 12,000 \leq m \leq 14,000$. She plans on driving between 12,000 and 14,000 miles.
84. (a) $T = 20 - \frac{h}{100}$, where T is the temperature in $^{\circ}\text{C}$, and h is the height in meters.
 (b) Solving the expression in part (a) for h , we get $h = 100(20 - T)$. So $0 \leq h \leq 5000 \Leftrightarrow 0 \leq 100(20 - T) \leq 5000 \Leftrightarrow 0 \leq 20 - T \leq 50 \Leftrightarrow -20 \leq -T \leq 30 \Leftrightarrow 20 \geq T \geq -30$. Thus the range of temperature is from 20°C down to -30°C .
85. (a) Let x be the number of \$3 increases. Then the number of seats sold is $120 - x$. So $P = 200 + 3x \Leftrightarrow 3x = P - 200 \Leftrightarrow x = \frac{1}{3}(P - 200)$. Substituting for x we have that the number of seats sold is $120 - x = 120 - \frac{1}{3}(P - 200) = -\frac{1}{3}P + \frac{560}{3}$.
 (b) $90 \leq -\frac{1}{3}P + \frac{560}{3} \leq 115 \Leftrightarrow 270 \leq 360 - P + 200 \leq 345 \Leftrightarrow 270 \leq -P + 560 \leq 345 \Leftrightarrow -290 \leq -P \leq -215 \Leftrightarrow 290 \geq P \geq 215$. Putting this into standard order, we have $215 \leq P \leq 290$. So the ticket prices are between \$215 and \$290.
86. If the customer buys x pounds of coffee at \$6.50 per pound, then his cost c will be $6.50x$. Thus $x = \frac{c}{6.5}$. Since the scale's accuracy is ± 0.03 lb, and the scale shows 3 lb, we have $3 - 0.03 \leq x \leq 3 + 0.03 \Leftrightarrow 2.97 \leq \frac{c}{6.5} \leq 3.03 \Leftrightarrow (6.50)2.97 \leq c \leq (6.50)3.03 \Leftrightarrow 19.305 \leq c \leq 19.695$. Since the customer paid \$19.50, he could have been over- or undercharged by as much as 19.5 cents.
87. $0.0004 \leq \frac{4,000,000}{d^2} \leq 0.01$. Since $d^2 \geq 0$ and $d \neq 0$, we can multiply each expression by d^2 to obtain $0.0004d^2 \leq 4,000,000 \leq 0.01d^2$. Solving each pair, we have $0.0004d^2 \leq 4,000,000 \Leftrightarrow d^2 \leq 10,000,000,000 \Rightarrow d \leq 100,000$ (recall that d represents distance, so it is always nonnegative). Solving $4,000,000 \leq 0.01d^2 \Leftrightarrow 400,000,000 \leq d^2 \Rightarrow 20,000 \leq d$. Putting these together, we have $20,000 \leq d \leq 100,000$.

88. $\frac{600,000}{x^2 + 300} < 500 \Leftrightarrow 600,000 < 500(x^2 + 300)$ (Note that $x^2 + 300 \geq 300 > 0$, so we can multiply both sides by the denominator and not worry that we might be multiplying both sides by a negative number or by zero.) $1200 < x^2 + 300 \Leftrightarrow 0 < x^2 - 900 \Leftrightarrow 0 < (x - 30)(x + 30)$. The expression in the inequality changes sign at $x = 30$ and $x = -30$. However, since x represents distance, we must have $x > 0$.

Interval	(0, 30)	(30, ∞)
Sign of $x - 30$	-	+
Sign of $x + 30$	+	+
Sign of $(x - 30)(x + 30)$	-	+

So $x > 30$ and you must stand at least 30 meters from the center of the fire.

89. $128 + 16t - 16t^2 \geq 32 \Leftrightarrow -16t^2 + 16t + 96 \geq 0 \Leftrightarrow -16(t^2 - t - 6) \geq 0 \Leftrightarrow -16(t - 3)(t + 2) \geq 0$. The expression on the left of the inequality changes sign at $x = -2$, at $t = 3$, and at $t = -2$. However, $t \geq 0$, so the only endpoint is $t = 3$.

Interval	(0, 3)	(3, ∞)
Sign of -16	-	-
Sign of $t - 3$	-	+
Sign of $t + 2$	+	+
Sign of $-16(t - 3)(t + 2)$	+	-

So $0 \leq t \leq 3$.

90. Solve $30 \leq 10 + 0.9v - 0.01v^2$ for $10 \leq v \leq 75$. We have $30 \leq 10 + 0.9v - 0.01v^2 \Leftrightarrow 0.01v^2 - 0.9v + 20 \leq 0 \Leftrightarrow (0.1v - 4)(0.1v - 5) \leq 0$. The possible endpoints are $0.1v - 4 = 0 \Leftrightarrow 0.1v = 4 \Leftrightarrow v = 40$ and $0.1v - 5 = 0 \Leftrightarrow 0.1v = 5 \Leftrightarrow v = 50$.

Interval	(10, 40)	(40, 50)	(50, 75)
Sign of $0.1v - 4$	-	+	+
Sign of $0.1v - 5$	-	-	+
Sign of $(0.1v - 4)(0.1v - 5)$	+	-	+

Thus he must drive between 40 and 50 mi/h.

91. $240 \geq v + \frac{v^2}{20} \Leftrightarrow \frac{1}{20}v^2 + v - 240 \leq 0 \Leftrightarrow \left(\frac{1}{20}v - 3\right)(v + 80) \leq 0$. The expression in the inequality changes sign at $v = 60$ and $v = -80$. However, since v represents the speed, we must have $v \geq 0$.

Interval	(0, 60)	(60, ∞)
Sign of $\frac{1}{20}v - 3$	-	+
Sign of $v + 80$	+	+
Sign of $\left(\frac{1}{20}v - 3\right)(v + 80)$	-	+

So Kerry must drive between 0 and 60 mi/h.

92. Solve $2400 \leq 20x - (2000 + 8x + 0.0025x^2) \Leftrightarrow 2400 \leq 20x - 2000 - 8x - 0.0025x^2 \Leftrightarrow 0.0025x^2 - 12x + 4400 \leq 0 \Leftrightarrow (0.0025x - 1)(x - 4400) \leq 0$. The expression on the left of the inequality changes sign when $x = 400$ and $x = 4400$. Since the manufacturer can only sell positive units, we check the intervals in the following table.

Interval	(0, 400)	(400, 4400)	(4400, ∞)
Sign of $0.0025x - 1$	-	+	+
Sign of $x - 4400$	-	-	+
Sign of $(0.0025x - 1)(x - 4400)$	+	-	+

So the manufacturer must sell between 400 and 4400 units to enjoy a profit of at least \$2400.

93. Let x be the length of the garden and w its width. Using the fact that the perimeter is 120 ft, we must have $2x + 2w = 120 \Leftrightarrow w = 60 - x$. Now since the area must be at least 800 ft^2 , we have $800 < x(60 - x) \Leftrightarrow 800 < 60x - x^2 \Leftrightarrow x^2 - 60x + 800 < 0 \Leftrightarrow (x - 20)(x - 40) < 0$. The expression in the inequality changes sign at $x = 20$ and $x = 40$. However, since x represents length, we must have $x > 0$.

Interval	(0, 20)	(20, 40)	(40, ∞)
Sign of $x - 20$	-	+	+
Sign of $x - 40$	-	-	+
Sign of $(x - 20)(x - 40)$	+	-	+

The length of the garden should be between 20 and 40 feet.

94. *Case 1:* $a < b < 0$ We have $a \cdot a > a \cdot b$, since $a < 0$, and $b \cdot a > b \cdot b$, since $b < 0$. So $a^2 > a \cdot b > b^2$, that is $a < b < 0 \Rightarrow a^2 > b^2$. Continuing, we have $a \cdot a^2 < a \cdot b^2$, since $a < 0$ and $b^2 \cdot a < b^2 \cdot b$, since $b^2 > 0$. So $a^3 < ab^2 < b^3$. Thus $a < b < 0 \Rightarrow a^3 > b^3$. So $a < b < 0 \Rightarrow a^n > b^n$, if n is even, and $a^n < b^n$, if n is odd.
- Case 2:* $0 < a < b$ We have $a \cdot a < a \cdot b$, since $a > 0$, and $b \cdot a < b \cdot b$, since $b > 0$. So $a^2 < a \cdot b < b^2$. Thus $0 < a < b \Rightarrow a^2 < b^2$. Likewise, $a^2 \cdot a < a^2 \cdot b$ and $b \cdot a^2 < b \cdot b^2$, thus $a^3 < b^3$. So $0 < a < b \Rightarrow a^n < b^n$, for all positive integers n .
- Case 3:* $a < 0 < b$ If n is odd, then $a^n < b^n$, because a^n is negative and b^n is positive. If n is even, then we could have either $a^n < b^n$ or $a^n > b^n$. For example, $-1 < 2$ and $(-1)^2 < 2^2$, but $-3 < 2$ and $(-3)^2 > 2^2$.

95. The rule we want to apply here is “ $a < b \Rightarrow ac < bc$ if $c > 0$ and $a < b \Rightarrow ac > bc$ if $c < 0$ ”. Thus we cannot simply multiply by x , since we don’t yet know if x is positive or negative, so in solving $1 < \frac{3}{x}$, we must consider two cases.

Case 1: $x > 0$ Multiplying both sides by x , we have $x < 3$. Together with our initial condition, we have $0 < x < 3$.

Case 2: $x < 0$ Multiplying both sides by x , we have $x > 3$. But $x < 0$ and $x > 3$ have no elements in common, so this gives no additional solution.

Hence, the only solutions are $0 < x < 3$.

96. $a < b$, so by Rule 1, $a + c < b + c$. Using Rule 1 again, $b + c < b + d$, and so by transitivity, $a + c < b + d$.
97. $\frac{a}{b} < \frac{c}{d}$, so by Rule 3, $d\frac{a}{b} < d\frac{c}{d} \Leftrightarrow \frac{ad}{b} < c$. Adding a to both sides, we have $\frac{ad}{b} + a < c + a$. Rewriting the left-hand side as $\frac{ad}{b} + \frac{ab}{b} = \frac{a(b+d)}{b}$ and dividing both sides by $b + d$ gives $\frac{a}{b} < \frac{a+c}{b+d}$.
- Similarly, $a + c < \frac{cb}{d} + c = \frac{c(b+d)}{d}$, so $\frac{a+c}{b+d} < \frac{c}{d}$.

1.8 SOLVING ABSOLUTE VALUE EQUATIONS AND INEQUALITIES

- The equation $|x| = 3$ has the two solutions -3 and 3 .
- (a) The solution of the inequality $|x| \leq 3$ is the interval $[-3, 3]$.
(b) The solution of the inequality $|x| \geq 3$ is a union of two intervals $(-\infty, -3] \cup [3, \infty)$.
- (a) The set of all points on the real line whose distance from zero is less than 3 can be described by the absolute value inequality $|x| < 3$.
(b) The set of all points on the real line whose distance from zero is greater than 3 can be described by the absolute value inequality $|x| > 3$.
- (a) $|2x - 1| = 5$ is equivalent to the two equations $2x - 1 = 5$ and $2x - 1 = -5$.
(b) $|3x + 2| \leq 8$ is equivalent to $-8 \leq 3x - 2 \leq 8$.
- $|5x| = 20 \Leftrightarrow 5x = \pm 20 \Leftrightarrow x = \pm 4$.
- $|-3x| = 10 \Leftrightarrow -3x = \pm 10 \Leftrightarrow x = \pm \frac{10}{3}$.
- $5|x| + 3 = 28 \Leftrightarrow 5|x| = 25 \Leftrightarrow |x| = 5 \Leftrightarrow x = \pm 5$.
- $\frac{1}{2}|x| - 7 = 2 \Leftrightarrow \frac{1}{2}|x| = 9 \Leftrightarrow |x| = 18 \Leftrightarrow x = \pm 18$.
- $|x - 3| = 2$ is equivalent to $x - 3 = \pm 2 \Leftrightarrow x = 3 \pm 2 \Leftrightarrow x = 1$ or $x = 5$.
- $|2x - 3| = 7$ is equivalent to either $2x - 3 = 7 \Leftrightarrow 2x = 10 \Leftrightarrow x = 5$; or $2x - 3 = -7 \Leftrightarrow 2x = -4 \Leftrightarrow x = -2$. The two solutions are $x = 5$ and $x = -2$.
- $|x + 4| = 0.5$ is equivalent to $x + 4 = \pm 0.5 \Leftrightarrow x = -4 \pm 0.5 \Leftrightarrow x = -4.5$ or $x = -3.5$.
- $|x + 4| = -3$. Since the absolute value is always nonnegative, there is no solution.
- $|2x - 3| = 11$ is equivalent to either $2x - 3 = 11 \Leftrightarrow 2x = 14 \Leftrightarrow x = 7$; or $2x - 3 = -11 \Leftrightarrow 2x = -8 \Leftrightarrow x = -4$. The two solutions are $x = 7$ and $x = -4$.
- $|2 - x| = 11$ is equivalent to either $2 - x = 11 \Leftrightarrow x = -9$; or $2 - x = -11 \Leftrightarrow x = 13$. The two solutions are $x = -9$ and $x = 13$.
- $4 - |3x + 6| = 1 \Leftrightarrow -|3x + 6| = -3 \Leftrightarrow |3x + 6| = 3$, which is equivalent to either $3x + 6 = 3 \Leftrightarrow 3x = -3 \Leftrightarrow x = -1$; or $3x + 6 = -3 \Leftrightarrow 3x = -9 \Leftrightarrow x = -3$. The two solutions are $x = -1$ and $x = -3$.
- $|5 - 2x| + 6 = 14 \Leftrightarrow |5 - 2x| = 8$ which is equivalent to either $5 - 2x = 8 \Leftrightarrow -2x = 3 \Leftrightarrow x = -\frac{3}{2}$; or $5 - 2x = -8 \Leftrightarrow -2x = -13 \Leftrightarrow x = \frac{13}{2}$. The two solutions are $x = -\frac{3}{2}$ and $x = \frac{13}{2}$.
- $3|x + 5| + 6 = 15 \Leftrightarrow 3|x + 5| = 9 \Leftrightarrow |x + 5| = 3$, which is equivalent to either $x + 5 = 3 \Leftrightarrow x = -2$; or $x + 5 = -3 \Leftrightarrow x = -8$. The two solutions are $x = -2$ and $x = -8$.
- $20 + |2x - 4| = 15 \Leftrightarrow |2x - 4| = -5$. Since the absolute value is always nonnegative, there is no solution.
- $8 + 5\left|\frac{1}{3}x - \frac{5}{6}\right| = 33 \Leftrightarrow 5\left|\frac{1}{3}x - \frac{5}{6}\right| = 25 \Leftrightarrow \left|\frac{1}{3}x - \frac{5}{6}\right| = 5$, which is equivalent to either $\frac{1}{3}x - \frac{5}{6} = 5 \Leftrightarrow \frac{1}{3}x = \frac{35}{6} \Leftrightarrow x = \frac{35}{2}$; or $\frac{1}{3}x - \frac{5}{6} = -5 \Leftrightarrow \frac{1}{3}x = -\frac{25}{6} \Leftrightarrow x = -\frac{25}{2}$. The two solutions are $x = -\frac{25}{2}$ and $x = \frac{35}{2}$.
- $\left|\frac{3}{5}x + 2\right| - \frac{1}{2} = 4 \Leftrightarrow \left|\frac{3}{5}x + 2\right| = \frac{9}{2}$ which is equivalent to either $\frac{3}{5}x + 2 = \frac{9}{2} \Leftrightarrow \frac{3}{5}x = \frac{5}{2} \Leftrightarrow x = \frac{25}{6}$; or $\frac{3}{5}x + 2 = -\frac{9}{2} \Leftrightarrow \frac{3}{5}x = -\frac{13}{2} \Leftrightarrow x = -\frac{65}{6}$. The two solutions are $x = \frac{25}{6}$ and $x = -\frac{65}{6}$.
- $|x - 1| = |3x + 2|$, which is equivalent to either $x - 1 = 3x + 2 \Leftrightarrow -2x = 3 \Leftrightarrow x = -\frac{3}{2}$; or $x - 1 = -(3x + 2) \Leftrightarrow x - 1 = -3x - 2 \Leftrightarrow 4x = -1 \Leftrightarrow x = -\frac{1}{4}$. The two solutions are $x = -\frac{3}{2}$ and $x = -\frac{1}{4}$.
- $|x + 3| = |2x + 1|$ is equivalent to either $x + 3 = 2x + 1 \Leftrightarrow -x = -2 \Leftrightarrow x = 2$; or $x + 3 = -(2x + 1) \Leftrightarrow x + 3 = -2x - 1 \Leftrightarrow 3x = -4 \Leftrightarrow x = -\frac{4}{3}$. The two solutions are $x = 2$ and $x = -\frac{4}{3}$.
- $|x| \leq 5 \Leftrightarrow -5 \leq x \leq 5$. Interval: $[-5, 5]$.

24. $|2x| \leq 20 \Leftrightarrow -20 \leq 2x \leq 20 \Leftrightarrow -10 \leq x \leq 10$. Interval: $[-10, 10]$.
25. $|2x| > 7$ is equivalent to $2x > 7 \Leftrightarrow x > \frac{7}{2}$; or $2x < -7 \Leftrightarrow x < -\frac{7}{2}$. Interval: $(-\infty, -\frac{7}{2}) \cup (\frac{7}{2}, \infty)$.
26. $\frac{1}{2}|x| \geq 1 \Leftrightarrow |x| \geq 2$ is equivalent to $x \geq 2$ or $x \leq -2$. Interval: $(-\infty, -2] \cup [2, \infty)$.
27. $|x - 4| \leq 10$ is equivalent to $-10 \leq x - 4 \leq 10 \Leftrightarrow -6 \leq x \leq 14$. Interval: $[-6, 14]$.
28. $|x - 3| > 9$ is equivalent to $x - 3 < -9 \Leftrightarrow x < -6$; or $x - 3 > 9 \Leftrightarrow x > 12$. Interval: $(-\infty, -6) \cup (12, \infty)$.
29. $|x + 1| \geq 1$ is equivalent to $x + 1 \geq 1 \Leftrightarrow x \geq 0$; or $x + 1 \leq -1 \Leftrightarrow x \leq -2$. Interval: $(-\infty, -2] \cup [0, \infty)$.
30. $|x + 4| \leq 0$ is equivalent to $|x + 4| = 0 \Leftrightarrow x + 4 = 0 \Leftrightarrow x = -4$. The only solution is $x = -4$.
31. $|2x + 1| \geq 3$ is equivalent to $2x + 1 \leq -3 \Leftrightarrow 2x \leq -4 \Leftrightarrow x \leq -2$; or $2x + 1 \geq 3 \Leftrightarrow 2x \geq 2 \Leftrightarrow x \geq 1$. Interval: $(-\infty, -2] \cup [1, \infty)$.
32. $|3x - 2| > 7$ is equivalent to $3x - 2 < -7 \Leftrightarrow 3x < -5 \Leftrightarrow x < -\frac{5}{3}$; or $3x - 2 > 7 \Leftrightarrow 3x > 9 \Leftrightarrow x > 3$. Interval: $(-\infty, -\frac{5}{3}) \cup (3, \infty)$.
33. $|2x - 3| \leq 0.4 \Leftrightarrow -0.4 \leq 2x - 3 \leq 0.4 \Leftrightarrow 2.6 \leq 2x \leq 3.4 \Leftrightarrow 1.3 \leq x \leq 1.7$. Interval: $[1.3, 1.7]$.
34. $|5x - 2| < 6 \Leftrightarrow -6 < 5x - 2 < 6 \Leftrightarrow -4 < 5x < 8 \Leftrightarrow -\frac{4}{5} < x < \frac{8}{5}$. Interval: $(-\frac{4}{5}, \frac{8}{5})$.
35. $\left| \frac{x-2}{3} \right| < 2 \Leftrightarrow -2 < \frac{x-2}{3} < 2 \Leftrightarrow -6 < x-2 < 6 \Leftrightarrow -4 < x < 8$. Interval: $(-4, 8)$.
36. $\left| \frac{x+1}{2} \right| \geq 4 \Leftrightarrow \left| \frac{1}{2}(x+1) \right| \geq 4 \Leftrightarrow \frac{1}{2}|x+1| \geq 4 \Leftrightarrow |x+1| \geq 8$ which is equivalent to either $x+1 \geq 8 \Leftrightarrow x \geq 7$; or $x+1 \leq -8 \Leftrightarrow x \leq -9$. Interval: $(-\infty, -9] \cup [7, \infty)$.
37. $|x+6| < 0.001 \Leftrightarrow -0.001 < x+6 < 0.001 \Leftrightarrow -6.001 < x < -5.999$. Interval: $(-6.001, -5.999)$.
38. $|x-a| < d \Leftrightarrow -d < x-a < d \Leftrightarrow a-d < x < a+d$. Interval: $(a-d, a+d)$.
39. $4|x+2| - 3 < 13 \Leftrightarrow 4|x+2| < 16 \Leftrightarrow |x+2| < 4 \Leftrightarrow -4 < x+2 < 4 \Leftrightarrow -6 < x < 2$. Interval: $(-6, 2)$.
40. $3 - |2x+4| \leq 1 \Leftrightarrow -|2x+4| \leq -2 \Leftrightarrow |2x+4| \geq 2$ which is equivalent to either $2x+4 \geq 2 \Leftrightarrow 2x \geq -2 \Leftrightarrow x \geq -1$; or $2x+4 \leq -2 \Leftrightarrow 2x \leq -6 \Leftrightarrow x \leq -3$. Interval: $(-\infty, -3] \cup [-1, \infty)$.
41. $8 - |2x-1| \geq 6 \Leftrightarrow -|2x-1| \geq -2 \Leftrightarrow |2x-1| \leq 2 \Leftrightarrow -2 \leq 2x-1 \leq 2 \Leftrightarrow -1 \leq 2x \leq 3 \Leftrightarrow -\frac{1}{2} \leq x \leq \frac{3}{2}$.
Interval: $[-\frac{1}{2}, \frac{3}{2}]$.
42. $7|x+2| + 5 > 4 \Leftrightarrow 7|x+2| > -1 \Leftrightarrow |x+2| > -\frac{1}{7}$. Since the absolute value is always nonnegative, the inequality is true for all real numbers. In interval notation, we have $(-\infty, \infty)$.
43. $\frac{1}{2}\left|4x + \frac{1}{3}\right| > \frac{5}{6} \Leftrightarrow \left|4x + \frac{1}{3}\right| > \frac{5}{3}$, which is equivalent to either $4x + \frac{1}{3} > \frac{5}{3} \Leftrightarrow 4x > \frac{4}{3} \Leftrightarrow x > \frac{1}{3}$; or $4x + \frac{1}{3} < -\frac{5}{3} \Leftrightarrow 4x < -2 \Leftrightarrow x < -\frac{1}{2}$. Interval: $(-\infty, -\frac{1}{2}) \cup (\frac{1}{3}, \infty)$.
44. $2\left|\frac{1}{2}x + 3\right| + 3 \leq 51 \Leftrightarrow 2\left|\frac{1}{2}x + 3\right| \leq 48 \Leftrightarrow \left|\frac{1}{2}x + 3\right| \leq 24 \Leftrightarrow -24 \leq \frac{1}{2}x + 3 \leq 24 \Leftrightarrow -27 \leq \frac{1}{2}x \leq 21 \Leftrightarrow -54 \leq x \leq 42$.
Interval: $[-54, 42]$.
45. $1 \leq |x| \leq 4$. If $x \geq 0$, then this is equivalent to $1 \leq x \leq 4$. If $x < 0$, then this is equivalent to $1 \leq -x \leq 4 \Leftrightarrow -1 \geq x \geq -4 \Leftrightarrow -4 \leq x \leq -1$. Interval: $[-4, -1] \cup [1, 4]$.
46. $0 < |x-5| \leq \frac{1}{2}$. For $x \neq 5$, this is equivalent to $-\frac{1}{2} \leq x-5 \leq \frac{1}{2} \Leftrightarrow \frac{9}{2} \leq x \leq \frac{11}{2}$. Since $x = 5$ is excluded, the solution is $[\frac{9}{2}, 5) \cup (5, \frac{11}{2}]$.
47. $\frac{1}{|x+7|} > 2 \Leftrightarrow 1 > 2|x+7|$ ($x \neq -7$) $\Leftrightarrow |x+7| < \frac{1}{2} \Leftrightarrow -\frac{1}{2} < x+7 < \frac{1}{2} \Leftrightarrow -\frac{15}{2} < x < -\frac{13}{2}$ and $x \neq -7$.
Interval: $(-\frac{15}{2}, -7) \cup (-7, -\frac{13}{2})$.

48. $\frac{1}{|2x-3|} \leq 5 \Leftrightarrow \frac{1}{5} \leq |2x-3|$, since $|2x-3| > 0$, provided $2x-3 \neq 0 \Leftrightarrow x \neq \frac{3}{2}$. Now for $x \neq \frac{3}{2}$, we have $\frac{1}{5} \leq |2x-3|$ is equivalent to either $\frac{1}{5} \leq 2x-3 \Leftrightarrow \frac{16}{5} \leq 2x \Leftrightarrow \frac{8}{5} \leq x$; or $2x-3 \leq -\frac{1}{5} \Leftrightarrow 2x \leq \frac{14}{5} \Leftrightarrow x \leq \frac{7}{5}$.
Interval: $(-\infty, \frac{7}{5}] \cup [\frac{8}{5}, \infty)$.

49. $|x| < 3$

50. $|x| > 2$

51. $|x-7| \geq 5$

52. $|x-2| \leq 4$

53. $|x| \leq 2$

54. $|x| \geq 1$

55. $|x| > 3$

56. $|x| < 4$

57. (a) Let x be the thickness of the laminate. Then $|x - 0.020| \leq 0.003$.

(b) $|x - 0.020| \leq 0.003 \Leftrightarrow -0.003 \leq x - 0.020 \leq 0.003 \Leftrightarrow 0.017 \leq x \leq 0.023$.

58. $\left| \frac{h-68.2}{2.9} \right| \leq 2 \Leftrightarrow -2 \leq \frac{h-68.2}{2.9} \leq 2 \Leftrightarrow -5.8 \leq h-68.2 \leq 5.8 \Leftrightarrow 62.4 \leq h \leq 74.0$. Thus 95% of the adult males are between 62.4 in and 74.0 in.

59. $|x-1|$ is the distance between x and 1; $|x-3|$ is the distance between x and 3. So $|x-1| < |x-3|$ represents those points closer to 1 than to 3, and the solution is $x < 2$, since 2 is the point halfway between 1 and 3. If $a < b$, then the solution to $|x-a| < |x-b|$ is $x < \frac{a+b}{2}$.

1.9 SOLVING EQUATIONS AND INEQUALITIES GRAPHICALLY

- The solutions of the equation $x^2 - 2x - 3 = 0$ are the x -intercepts of the graph of $y = x^2 - 2x - 3$.
- The solutions of the inequality $x^2 - 2x - 3 > 0$ are the x -coordinates of the points on the graph of $y = x^2 - 2x - 3$ that lie above the x -axis.
- (a) From the graph, it appears that the graph of $y = x^4 - 3x^3 - x^2 + 3x$ has x -intercepts $-1, 0, 1$, and 3 , so the solutions to the equation $x^4 - 3x^3 - x^2 + 3x = 0$ are $x = -1, x = 0, x = 1$, and $x = 3$.
(b) From the graph, we see that where $-1 \leq x \leq 0$ or $1 \leq x \leq 3$, the graph lies below the x -axis. Thus, the inequality $x^4 - 3x^3 - x^2 + 3x \leq 0$ is satisfied for $\{x \mid -1 \leq x \leq 0 \text{ or } 1 \leq x \leq 3\} = [-1, 0] \cup [1, 3]$.
- (a) The graphs of $y = 5x - x^2$ and $y = 4$ intersect at $x = 1$ and at $x = 4$, so the equation $5x - x^2 = 4$ has solutions $x = 1$ and $x = 4$.
(b) The graph of $y = 5x - x^2$ lies strictly above the graph of $y = 4$ when $1 < x < 4$, so the inequality $5x - x^2 > 4$ is satisfied for those values of x , that is, for $\{x \mid 1 < x < 4\} = (1, 4)$.
- Algebraically: $x - 4 = 5x + 12 \Leftrightarrow -16 = 4x \Leftrightarrow x = -4$. Graphically: We graph the two equations $y_1 = x - 4$ and $y_2 = 5x + 12$ in the viewing rectangle $[-6, 4]$ by $[-10, 2]$. Zooming in, we see that the solution is $x = -4$.
- Algebraically: $\frac{1}{2}x - 3 = 6 + 2x \Leftrightarrow -9 = \frac{3}{2}x \Leftrightarrow x = -6$. Graphically: We graph the two equations $y_1 = \frac{1}{2}x - 3$ and $y_2 = 6 + 2x$ in the viewing rectangle $[-10, 5]$ by $[-10, 5]$. Zooming in, we see that the solution is $x = -6$.

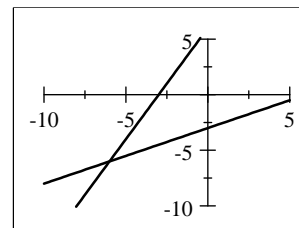
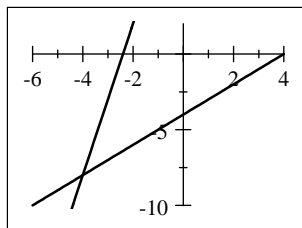

7. Algebraically: $\frac{2}{x} + \frac{1}{2x} = 7 \Leftrightarrow 2x \left(\frac{2}{x} + \frac{1}{2x} \right) = 2x(7)$
 $\Leftrightarrow 4 + 1 = 14x \Leftrightarrow x = \frac{5}{14}$.

Graphically: We graph the two equations $y_1 = \frac{2}{x} + \frac{1}{2x}$ and $y_2 = 7$ in the viewing rectangle $[-2, 2]$ by $[-2, 8]$.

Zooming in, we see that the solution is $x \approx 0.36$.

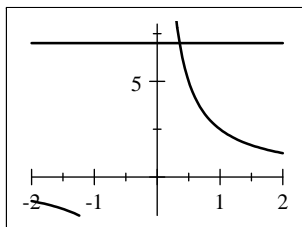

9. Algebraically: $x^2 - 32 = 0 \Leftrightarrow x^2 = 32 \Rightarrow$
 $x = \pm\sqrt{32} = \pm 4\sqrt{2}$.

Graphically: We graph the equation $y_1 = x^2 - 32$ and determine where this curve intersects the x -axis. We use the viewing rectangle $[-10, 10]$ by $[-5, 5]$. Zooming in, we see that solutions are $x \approx 5.66$ and $x \approx -5.66$.

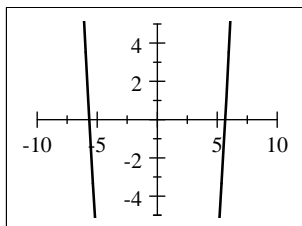

11. Algebraically: $x^2 + 9 = 0 \Leftrightarrow x^2 = -9$, which has no real solution.

Graphically: We graph the equation $y = x^2 + 9$ and see that this curve does not intersect the x -axis. We use the viewing rectangle $[-5, 5]$ by $[-5, 30]$.

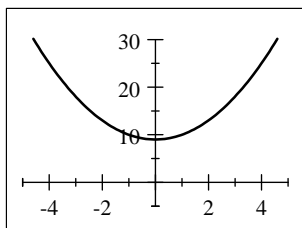

8. Algebraically: $\frac{4}{x+2} - \frac{6}{2x} = \frac{5}{2x+4} \Leftrightarrow$
 $2x(x+2) \left(\frac{4}{x+2} - \frac{6}{2x} \right) = 2x(x+2) \left(\frac{5}{2x+4} \right) \Leftrightarrow$
 $2x(4) - (x+2)(6) = x(5) \Leftrightarrow 8x - 6x - 12 = 5x \Leftrightarrow$
 $-12 = 3x \Leftrightarrow -4 = x$.

Graphically: We graph the two equations

$y_1 = \frac{4}{x+2} - \frac{6}{2x}$ and $y_2 = \frac{5}{2x+4}$ in the viewing rectangle $[-5, 5]$ by $[-10, 10]$. Zooming in, we see that there is only one solution at $x = -4$.

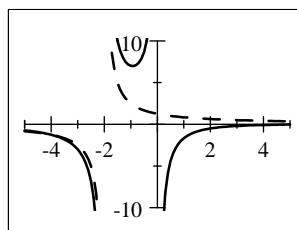

10. Algebraically: $x^3 + 16 = 0 \Leftrightarrow x^3 = -16 \Leftrightarrow x = -2\sqrt[3]{2}$.

Graphically: We graph the equation $y = x^3 + 16$ and determine where this curve intersects the x -axis. We use the viewing rectangle $[-5, 5]$ by $[-5, 5]$. Zooming in, we see that the solution is $x \approx -2.52$.

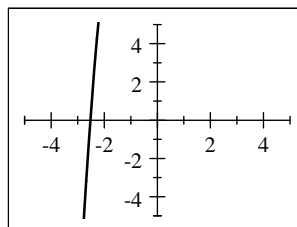

12. Algebraically: $x^2 + 3 = 2x \Leftrightarrow x^2 - 2x + 3 = 0 \Leftrightarrow$

$$x = \frac{-(-2) \pm \sqrt{(-2)^2 - 4(1)(3)}}{2(1)} = \frac{2 \pm \sqrt{-8}}{2(1)}$$

Because the discriminant is negative, there is no real solution.

Graphically: We graph the two equations $y_1 = x^2 + 3$ and $y_2 = 2x$ in the viewing rectangle $[-4, 6]$ by $[-6, 12]$, and see that the two curves do not intersect.

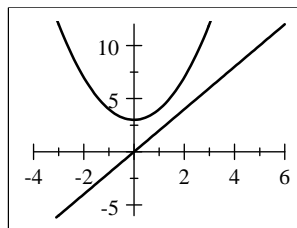

13. Algebraically: $16x^4 = 625 \Leftrightarrow x^4 = \frac{625}{16} \Rightarrow$

$$x = \pm\sqrt[4]{\frac{625}{16}} = \pm 2.5.$$

Graphically: We graph the two equations $y_1 = 16x^4$ and $y_2 = 625$ in the viewing rectangle $[-5, 5]$ by $[610, 640]$.

Zooming in, we see that solutions are $x = \pm 2.5$.

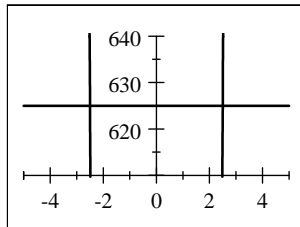

14. Algebraically: $2x^5 - 243 = 0 \Leftrightarrow 2x^5 = 243 \Leftrightarrow x^5 = \frac{243}{2}$

$$\Leftrightarrow x = \sqrt[5]{\frac{243}{2}} = \frac{3}{2}\sqrt[5]{16}.$$

Graphically: We graph the equation $y = 2x^5 - 243$ and determine where this curve intersects the x -axis. We use the viewing rectangle $[-5, 10]$ by $[-5, 5]$.

Zooming in, we see that the solution is $x \approx 2.61$.

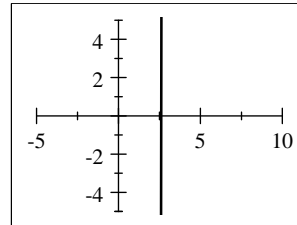

15. Algebraically: $(x - 5)^4 - 80 = 0 \Leftrightarrow (x - 5)^4 = 80 \Rightarrow$

$$x - 5 = \pm\sqrt[4]{80} = \pm 2\sqrt[4]{5} \Leftrightarrow x = 5 \pm 2\sqrt[4]{5}.$$

Graphically: We graph the equation $y_1 = (x - 5)^4 - 80$ and determine where this curve intersects the x -axis. We use the viewing rectangle $[-1, 9]$ by $[-5, 5]$. Zooming in, we see that solutions are $x \approx 2.01$ and $x \approx 7.99$.

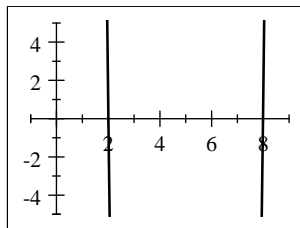

16. Algebraically: $6(x + 2)^5 = 64 \Leftrightarrow (x + 2)^5 = \frac{64}{6} = \frac{32}{3}$

$$\Leftrightarrow x + 2 = \sqrt[5]{\frac{32}{3}} = \frac{2}{3}\sqrt[5]{81} \Leftrightarrow x = -2 + \frac{2}{3}\sqrt[5]{81}.$$

Graphically: We graph the two equations $y_1 = 6(x + 2)^5$ and $y_2 = 64$ in the viewing rectangle $[-5, 5]$ by $[50, 70]$.

Zooming in, we see that the solution is $x \approx -0.39$.

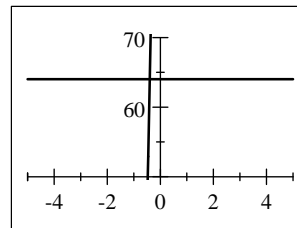

17. We graph $y = x^2 - 7x + 12$ in the viewing rectangle $[0, 6]$ by $[-0.1, 0.1]$. The solutions appear to be exactly $x = 3$ and $x = 4$. [In fact $x^2 - 7x + 12 = (x - 3)(x - 4)$.]

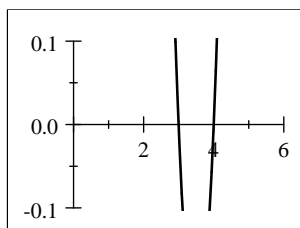

18. We graph $y = x^2 - 0.75x + 0.125$ in the viewing rectangle $[-2, 2]$ by $[-0.1, 0.1]$. The solutions are $x = 0.25$ and $x = 0.50$.

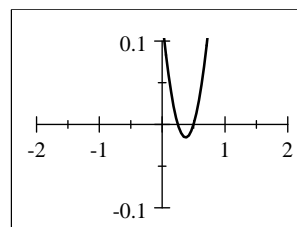

19. We graph $y = x^3 - 6x^2 + 11x - 6$ in the viewing rectangle $[-1, 4]$ by $[-0.1, 0.1]$. The solutions are $x = 1.00, x = 2.00,$ and $x = 3.00$.

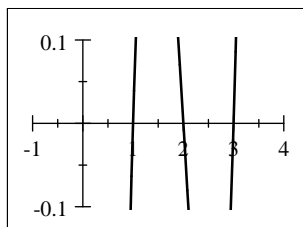

20. Since $16x^3 + 16x^2 = x + 1 \Leftrightarrow 16x^3 + 16x^2 - x - 1 = 0$, we graph $y = 16x^3 + 16x^2 - x - 1$ in the viewing rectangle $[-2, 2]$ by $[-0.1, 0.1]$. The solutions are: $x = -1.00, x = -0.25,$ and $x = 0.25$.

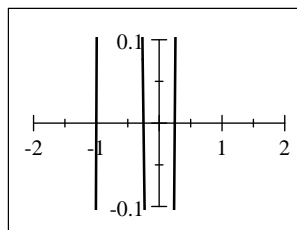

21. We first graph $y = x - \sqrt{x+1}$ in the viewing rectangle $[-1, 5]$ by $[-0.1, 0.1]$ and find that the solution is near 1.6. Zooming in, we see that solutions is $x \approx 1.62$.

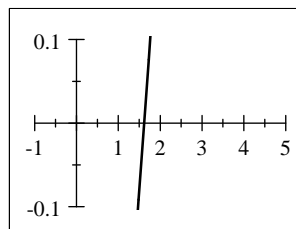

22. $1 + \sqrt{x} = \sqrt{1+x^2} \Leftrightarrow$

$1 + \sqrt{x} - \sqrt{1+x^2} = 0$. Since \sqrt{x} is only defined for $x \geq 0$, we start with the viewing rectangle $[-1, 5]$ by $[-1, 1]$. In this rectangle, there appears to be an exact solution at $x = 0$ and another solution between $x = 2$ and $x = 2.5$. We then use the viewing rectangle $[2.3, 2.35]$ by $[-0.01, 0.01]$, and isolate the second solution as $x \approx 2.314$. Thus the solutions are $x = 0$ and $x \approx 2.31$.

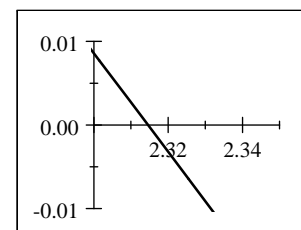
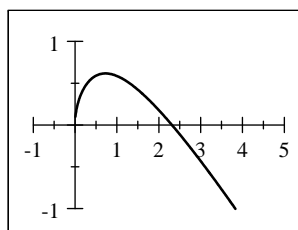

23. We graph $y = x^{1/3} - x$ in the viewing rectangle $[-3, 3]$ by $[-1, 1]$. The solutions are $x = -1, x = 0,$ and $x = 1$, as can be verified by substitution.

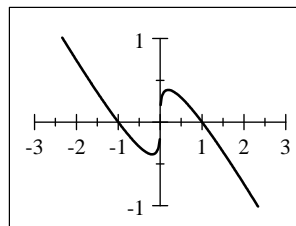

24. Since $x^{1/2}$ is defined only for $x \geq 0$, we start by graphing $y = x^{1/2} + x^{1/3} - x$ in the viewing rectangle $[-1, 5]$ by $[-1, 1]$. We see a solution at $x = 0$ and another one between $x = 3$ and $x = 3.5$. We then use the viewing rectangle $[3.3, 3.4]$ by $[-0.01, 0.01]$, and isolate the second solution as $x \approx 3.31$. Thus, the solutions are $x = 0$ and $x \approx 3.31$.

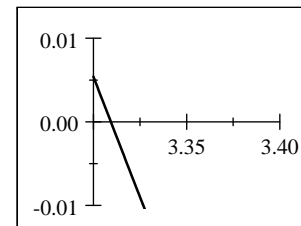
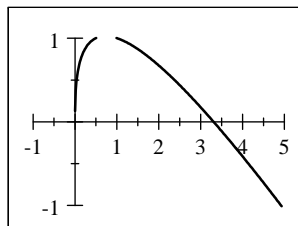

25. We graph $y = \sqrt{2x+1} + 1$ and $y = x$ in the viewing rectangle $[-3, 6]$ by $[0, 6]$ and see that the only solution to the equation $\sqrt{2x+1} + 1 = x$ is $x = 4$, which can be verified by substitution.

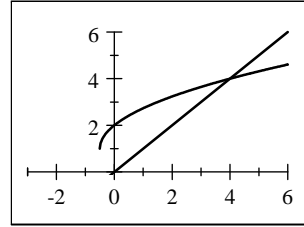

26. We graph $y = \sqrt{3-x} + 2$ and $y = 1 - x$ in the viewing rectangle $[-7, 4]$ by $[-2, 8]$ and see that the only solution to the equation $\sqrt{3-x} + 2 = 1 - x$ is $x \approx -3.56$, which can be verified by substitution.

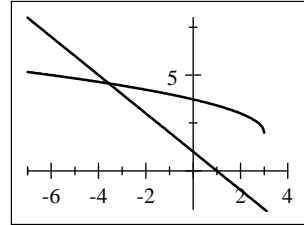

27. We graph $y = 2x^4 + 4x^2 + 1$ in the viewing rectangle $[-2, 2]$ by $[-5, 40]$ and see that the equation $2x^4 + 4x^2 + 1 = 0$ has no solution.

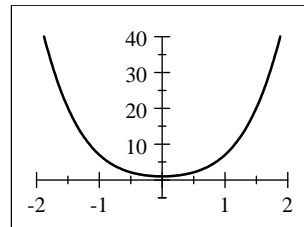

28. We graph $y = x^6 - 2x^3 - 3$ in the viewing rectangle $[-2, 2]$ by $[-5, 15]$ and see that the equation $x^6 - 2x^3 - 3 = 0$ has solutions $x = -1$ and $x \approx 1.44$, which can be verified by substitution.

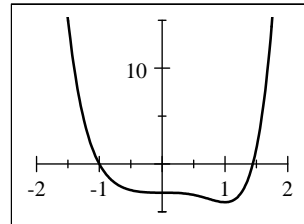

29. $x^3 - 2x^2 - x - 1 = 0$, so we start by graphing the function $y = x^3 - 2x^2 - x - 1$ in the viewing rectangle $[-10, 10]$ by $[-100, 100]$. There appear to be two solutions, one near $x = 0$ and another one between $x = 2$ and $x = 3$. We then use the viewing rectangle $[-1, 5]$ by $[-1, 1]$ and zoom in on the only solution, $x \approx 2.55$.

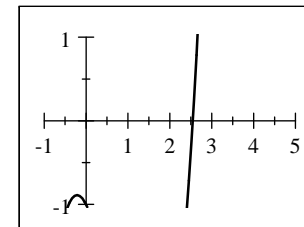
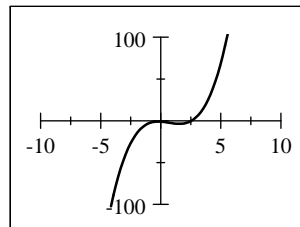

30. $x^4 - 8x^2 + 2 = 0$. We start by graphing the function $y = x^4 - 8x^2 + 2$ in the viewing rectangle $[-10, 10]$ by $[-10, 10]$. There appear to be four solutions between $x = -3$ and $x = 3$. We then use the viewing rectangle $[-5, 5]$ by $[-1, 1]$, and zoom to find the four solutions $x \approx -2.78$, $x \approx -0.51$, $x \approx 0.51$, and $x \approx 2.78$.

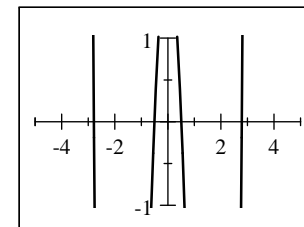
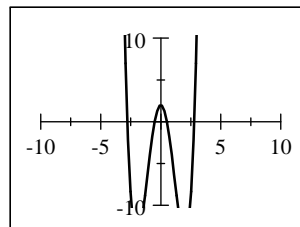

31. $x(x-1)(x+2) = \frac{1}{6}x \Leftrightarrow$

$x(x-1)(x+2) - \frac{1}{6}x = 0$. We start by graphing the function $y = x(x-1)(x+2) - \frac{1}{6}x$ in the viewing rectangle $[-5, 5]$ by $[-10, 10]$. There appear to be three solutions. We then use the viewing rectangle $[-2.5, 2.5]$ by $[-1, 1]$ and zoom into the solutions at $x \approx -2.05$, $x = 0.00$, and $x \approx 1.05$.

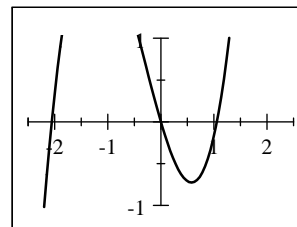
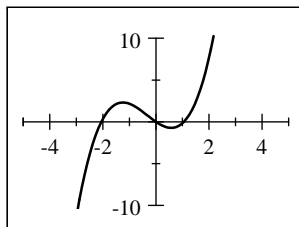

32. $x^4 = 16 - x^3$. We start by graphing the functions $y_1 = x^4$ and $y_2 = 16 - x^3$ in the viewing rectangle $[-10, 10]$ by $[-5, 40]$. There appears to be two solutions, one near $x = -2$ and another one near $x = 2$. We then use the viewing rectangle $[-2.4, -2.2]$ by $[27, 29]$, and zoom in to find the solution at $x \approx -2.31$. We then use the viewing rectangle $[1.7, 1.8]$ by $[9.5, 10.5]$, and zoom in to find the solution at $x \approx 1.79$.

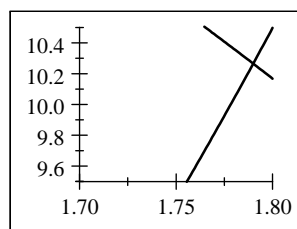
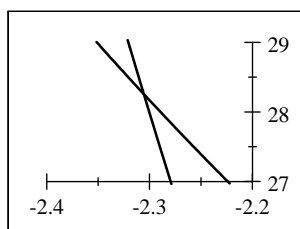
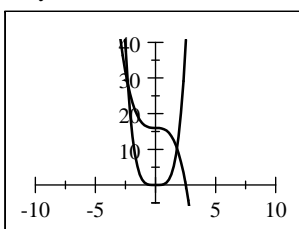

33. We graph $y = x^2$ and $y = 3x + 10$ in the viewing rectangle $[-4, 7]$ by $[-5, 30]$. The solution to the inequality is $[-2, 5]$.

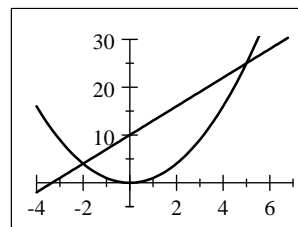

34. Since $0.5x^2 + 0.875x \leq 0.25 \Leftrightarrow 0.5x^2 + 0.875x - 0.25 \leq 0$, we graph $y = 0.5x^2 + 0.875x - 0.25$ in the viewing rectangle $[-3, 1]$ by $[-5, 5]$. Thus the solution to the inequality is $[-2, 0.25]$.

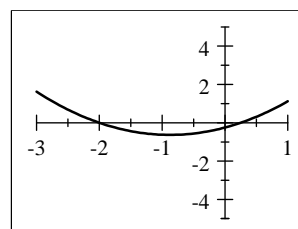

35. Since $x^3 + 11x \leq 6x^2 + 6 \Leftrightarrow x^3 - 6x^2 + 11x - 6 \leq 0$, we graph $y = x^3 - 6x^2 + 11x - 6$ in the viewing rectangle $[0, 5]$ by $[-5, 5]$. The solution set is $(-\infty, 1.0] \cup [2.0, 3.0]$.

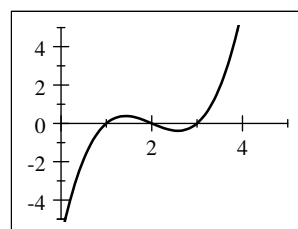

36. Since $16x^3 + 24x^2 > -9x - 1 \Leftrightarrow 16x^3 + 24x^2 + 9x + 1 > 0$, we graph $y = 16x^3 + 24x^2 + 9x + 1$ in the viewing rectangle $[-3, 1]$ by $[-5, 5]$. From this rectangle, we see that $x = -1$ is an x -intercept, but it is unclear what is occurring between $x = -0.5$ and $x = 0$. We then use the viewing rectangle $[-1, 0]$ by $[-0.01, 0.01]$. It shows $y = 0$ at $x = -0.25$. Thus in interval notation, the solution is $(-1, -0.25) \cup (-0.25, \infty)$.

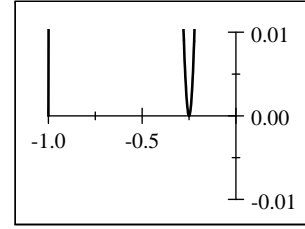
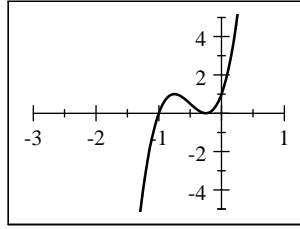

37. Since $x^{1/3} \leq x \Leftrightarrow x^{1/3} - x < 0$, we graph $y = x^{1/3} - x$ in the viewing rectangle $[-3, 3]$ by $[-1, 1]$. From this, we find that the solution set is $(-1, 0) \cup (1, \infty)$.

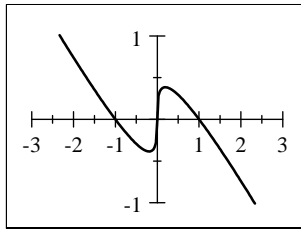

38. Since $\sqrt{0.5x^2 + 1} \leq 2|x| \Leftrightarrow \sqrt{0.5x^2 + 1} - 2|x| \leq 0$, we graph $y = \sqrt{0.5x^2 + 1} - 2|x|$ in the viewing rectangle $[-1, 1]$ by $[-1, 1]$. We locate the x -intercepts at $x \approx \pm 0.535$. Thus in interval notation, the solution is approximately $(-\infty, -0.535] \cup [0.535, \infty)$.

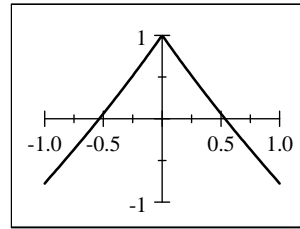

39. Since $(x + 1)^2 < (x - 1)^2 \Leftrightarrow (x + 1)^2 - (x - 1)^2 < 0$, we graph $y = (x + 1)^2 - (x - 1)^2$ in the viewing rectangle $[-2, 2]$ by $[-5, 5]$. The solution set is $(-\infty, 0)$.

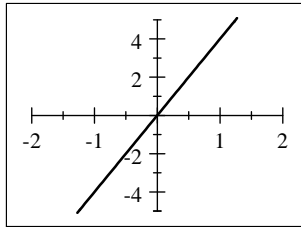

40. Since $(x + 1)^2 \leq x^3 \Leftrightarrow (x + 1)^2 - x^3 \leq 0$, we graph $y = (x + 1)^2 - x^3$ in the viewing rectangle $[-4, 4]$ by $[-1, 1]$. The x -intercept is close to $x = 2$. Using a trace function, we obtain $x \approx 2.148$. Thus the solution is $[2.148, \infty)$.

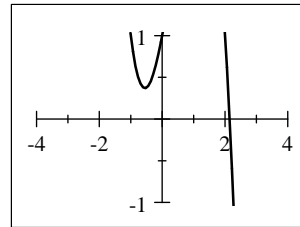

41. We graph the equations $y = 3x^2 - 3x$ and $y = 2x^2 + 4$ in the viewing rectangle $[-2, 6]$ by $[-5, 50]$. We see that the two curves intersect at $x = -1$ and at $x = 4$, and that the first curve is lower than the second for $-1 < x < 4$. Thus, we see that the inequality $3x^2 - 3x < 2x^2 + 4$ has the solution set $(-1, 4)$.

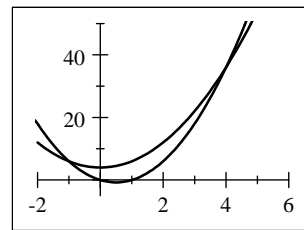

42. We graph the equations $y = 5x^2 + 3x$ and $y = 3x^2 + 2$ in the viewing rectangle $[-3, 2]$ by $[-5, 20]$. We see that the two curves intersect at $x = -2$ and at $x = \frac{1}{2}$, which can be verified by substitution. The first curve is larger than the second for $x < -2$ and for $x > \frac{1}{2}$, so the solution set of the inequality $5x^2 + 3x \geq 3x^2 + 2$ is $(-\infty, -2] \cup [\frac{1}{2}, \infty)$.

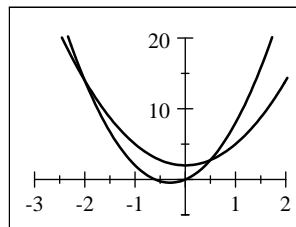

43. We graph the equation $y = (x - 2)^2(x - 3)(x + 1)$ in the viewing rectangle $[-2, 4]$ by $[-15, 5]$ and see that the inequality $(x - 2)^2(x - 3)(x + 1) \leq 0$ has the solution set $[-1, 3]$.

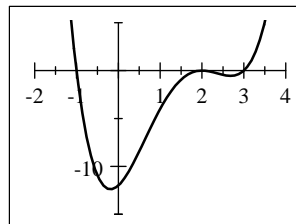

44. We graph the equation $y = x^2(x^2 - 1)$ in the viewing rectangle $[-2, 2]$ by $[-1, 1]$ and see that the inequality $x^2(x^2 - 1) \geq 0$ has the solution set $(-\infty, -1] \cup \{0\} \cup [1, \infty)$.

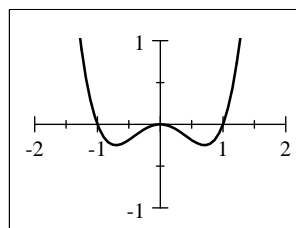

45. To solve $5 - 3x = 8x - 20$ by drawing the graph of a single equation, we isolate all terms on the left-hand side: $5 - 3x = 8x - 20 \Leftrightarrow 5 - 3x - 8x + 20 = 8x - 20 - 8x + 20 \Leftrightarrow -11x + 25 = 0$ or $11x - 25 = 0$. We graph $y = 11x - 25$, and see that the solution is $x \approx 2.27$, as in Example 2.

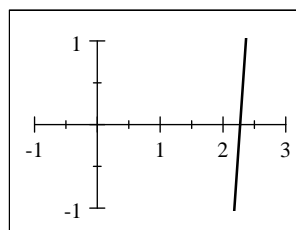

46. Graphing $y = x^3 - 6x^2 + 9x$ and $y = \sqrt{x}$ in the viewing rectangle $[-0.01, 0.02]$ by $[-0.05, 0.2]$, we see that $x = 0$ and $x = 0.01$ are solutions of the equation $x^3 - 6x^2 + 9x = \sqrt{x}$.

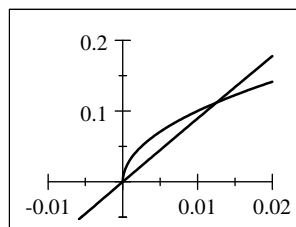

47. (a) We graph the equation

$y = 10x + 0.5x^2 - 0.001x^3 - 5000$ in the viewing rectangle $[0, 600]$ by $[-30000, 20000]$.

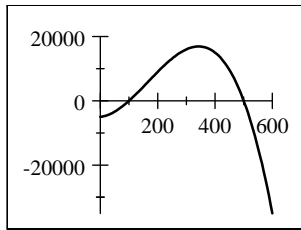

- (b) From the graph it appears that

$0 < 10x + 0.5x^2 - 0.001x^3 - 5000$ for $100 < x < 500$, and so 101 cooktops must be produced to begin to make a profit.

48. (a)

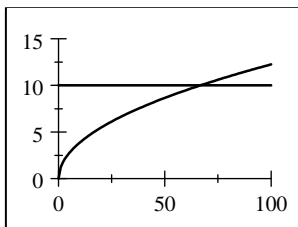

- (b) Using a zoom or trace function, we find that $y \geq 10$ for $x \geq 66.7$. We

could estimate this since if $x < 100$, then $(\frac{x}{5280})^2 \leq 0.00036$. So for $x < 100$ we have $\sqrt{1.5x + (\frac{x}{5280})^2} \approx \sqrt{1.5x}$. Solving $\sqrt{1.5x} > 10$ we get $1.5 > 100$ or $x > \frac{100}{1.5} = 66.7$ mi.

- (c) We graph the equations $y = 15,000$ and

$y = 10x + 0.5x^2 - 0.001x^3 - 5000$ in the viewing rectangle $[250, 450]$ by $[11000, 17000]$. We use a zoom or trace function on a graphing calculator, and find that the company's profits are greater than \$15,000 for $279 < x < 400$.

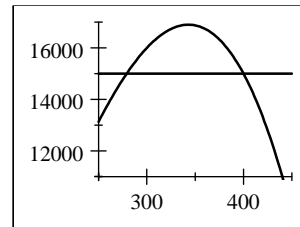

49. Answers will vary.

50. Calculators perform operations in the following order: exponents are applied before division and division is applied before addition. Therefore, $Y_1=x^{1/3}$ is interpreted as $y = \frac{x^1}{3} = \frac{x}{3}$, which is the equation of a line. Likewise, $Y_2=x/x+4$ is interpreted as $y = \frac{x}{x} + 4 = 1 + 4 = 5$. Instead, enter the following: $Y_1=x^{(1/3)}$, $Y_2=x/(x+4)$.

1.10 MODELING VARIATION

- If the quantities x and y are related by the equation $y = 3x$ then we say that y is *directly proportional* to x , and the constant of *proportionality* is 3.
- If the quantities x and y are related by the equation $y = \frac{3}{x}$ then we say that y is *inversely proportional* to x , and the constant of *proportionality* is 3.
- If the quantities x , y , and z are related by the equation $z = 3\frac{x}{y}$ then we say that z is *directly proportional* to x and *inversely proportional* to y .
- Because z is jointly proportional to x and y , we must have $z = kxy$. Substituting the given values, we get $10 = k(4)(5) = 20k \Leftrightarrow k = \frac{1}{2}$. Thus, x , y , and z are related by the equation $z = \frac{1}{2}xy$.
- (a) In the equation $y = 3x$, y is directly proportional to x .
(b) In the equation $y = 3x + 1$, y is not proportional to x .
- (a) In the equation $y = \frac{3}{x+1}$, y is not proportional to x .
(b) In the equation $y = \frac{3}{x}$, y is inversely proportional to x .

7. $T = kx$, where k is constant.
9. $v = \frac{k}{z}$, where k is constant.
11. $y = \frac{kS}{t}$, where k is constant.
13. $z = k\sqrt{y}$, where k is constant.
15. $V = klwh$, where k is constant.
17. $R = \frac{kP^2t^2}{b^3}$, where k is constant.
19. Since y is directly proportional to x , $y = kx$. Since $y = 42$ when $x = 6$, we have $42 = k(6) \Leftrightarrow k = 7$. So $y = 7x$.
20. w is inversely proportional to t , so $w = \frac{k}{t}$. Since $w = 3$ when $t = 8$, we have $3 = \frac{k}{8} \Leftrightarrow k = 24$, so $w = \frac{24}{t}$.
21. A varies inversely as r , so $A = \frac{k}{r}$. Since $A = 7$ when $r = 3$, we have $7 = \frac{k}{3} \Leftrightarrow k = 21$. So $A = \frac{21}{r}$.
22. P is directly proportional to T , so $P = kT$. Since $P = 20$ when $T = 300$, we have $20 = k(300) \Leftrightarrow k = \frac{1}{15}$. So $P = \frac{1}{15}T$.
23. Since A is directly proportional to x and inversely proportional to t , $A = \frac{kx}{t}$. Since $A = 42$ when $x = 7$ and $t = 3$, we have $42 = \frac{k(7)}{3} \Leftrightarrow k = 18$. Therefore, $A = \frac{18x}{t}$.
24. $S = kpq$. Since $S = 180$ when $p = 4$ and $q = 5$, we have $180 = k(4)(5) \Leftrightarrow 180 = 20k \Leftrightarrow k = 9$. So $S = 9pq$.
25. Since W is inversely proportional to the square of r , $W = \frac{k}{r^2}$. Since $W = 10$ when $r = 6$, we have $10 = \frac{k}{(6)^2} \Leftrightarrow k = 360$.
So $W = \frac{360}{r^2}$.
26. $t = k\frac{xy}{r}$. Since $t = 25$ when $x = 2$, $y = 3$, and $r = 12$, we have $25 = k\frac{(2)(3)}{12} \Leftrightarrow k = 50$. So $t = 50\frac{xy}{r}$.
27. Since C is jointly proportional to l , w , and h , we have $C = klwh$. Since $C = 128$ when $l = w = h = 2$, we have $128 = k(2)(2)(2) \Leftrightarrow 128 = 8k \Leftrightarrow k = 16$. Therefore, $C = 16lwh$.
28. $H = kl^2w^2$. Since $H = 36$ when $l = 2$ and $w = \frac{1}{3}$, we have $36 = k(2)^2\left(\frac{1}{3}\right)^2 \Leftrightarrow 36 = \frac{4}{9}k \Leftrightarrow k = 81$. So $H = 81l^2w^2$.
29. $R = \frac{k}{\sqrt{x}}$. Since $R = 2.5$ when $x = 121$, $2.5 = \frac{k}{\sqrt{121}} = \frac{k}{11} \Leftrightarrow k = 27.5$. Thus, $R = \frac{27.5}{\sqrt{x}}$.
30. $M = k\frac{abc}{d}$. Since $M = 128$ when $a = d$ and $b = c = 2$, we have $128 = k\frac{a(2)(2)}{a} = 4k \Leftrightarrow k = 32$. So $M = 32\frac{abc}{d}$.
31. (a) $z = k\frac{x^3}{y^2}$
(b) If we replace x with $3x$ and y with $2y$, then $z = k\frac{(3x)^3}{(2y)^2} = \frac{27}{4}\left(k\frac{x^3}{y^2}\right)$, so z changes by a factor of $\frac{27}{4}$.
32. (a) $z = k\frac{x^2}{y^4}$
(b) If we replace x with $3x$ and y with $2y$, then $z = k\frac{(3x)^2}{(2y)^4} = \frac{9}{16}\left(k\frac{x^2}{y^4}\right)$, so z changes by a factor of $\frac{9}{16}$.
33. (a) $z = kx^3y^5$
(b) If we replace x with $3x$ and y with $2y$, then $z = k(3x)^3(2y)^5 = 864kx^3y^5$, so z changes by a factor of 864.

34. (a) $z = \frac{k}{x^2y^3}$
- (b) If we replace x with $3x$ and y with $2y$, then $z = \frac{k}{(3x)^2(2y)^3} = \frac{1}{72} \frac{k}{x^2y^3}$, so z changes by a factor of $\frac{1}{72}$.
35. (a) The force F needed is $F = kx$.
- (b) Since $F = 30$ N when $x = 9$ cm and the spring's natural length is 5 cm, we have $30 = k(9 - 5) \Leftrightarrow k = 7.5$.
- (c) From part (b), we have $F = 7.5x$. Substituting $x = 11 - 5 = 6$ into $F = 7.5x$ gives $F = 7.5(6) = 45$ N.
36. (a) $C = kpm$
- (b) Since $C = 60,000$ when $p = 120$ and $m = 4000$, we get $60,000 = k(120)(4000) \Leftrightarrow k = \frac{1}{8}$. So $C = \frac{1}{8}pm$.
- (c) Substituting $p = 92$ and $m = 5000$, we get $C = \frac{1}{8}(92)(5000) = \$57,500$.
37. (a) $P = ks^3$.
- (b) Since $P = 96$ when $s = 20$, we get $96 = k \cdot 20^3 \Leftrightarrow k = 0.012$. So $P = 0.012s^3$.
- (c) Substituting $s = 30$, we get $P = 0.012 \cdot 30^3 = 324$ watts.
38. (a) The power P is directly proportional to the cube of the speed s , so $P = ks^3$.
- (b) Because $P = 80$ when $s = 10$, we have $80 = k(10)^3 \Leftrightarrow k = \frac{80}{1000} = \frac{2}{25} = 0.08$.
- (c) Substituting $k = \frac{2}{25}$ and $s = 15$, we have $P = \frac{2}{25}(15)^3 = 270$ hp.
39. $D = ks^2$. Since $D = 150$ when $s = 40$, we have $150 = k(40)^2$, so $k = 0.09375$. Thus, $D = 0.09375s^2$. If $D = 200$, then $200 = 0.09375s^2 \Leftrightarrow s^2 \approx 2133.3$, so $s \approx 46$ mi/h (for safety reasons we round down).
40. $L = ks^2A$. Since $L = 1700$ when $s = 50$ and $A = 500$, we have $1700 = k(50^2)(500) \Leftrightarrow k = 0.00136$. Thus $L = 0.00136s^2A$. When $A = 600$ and $s = 40$ we get the lift is $L = 0.00136(40^2)(600) = 1305.6$ lb.
41. $F = kAs^2$. Since $F = 220$ when $A = 40$ and $s = 5$. Solving for k we have $220 = k(40)(5)^2 \Leftrightarrow 220 = 1000k \Leftrightarrow k = 0.22$. Now when $A = 28$ and $F = 175$ we get $175 = 0.220(28)s^2 \Leftrightarrow 28.4090 = s^2$ so $s = \sqrt{28.4090} = 5.33$ mi/h.
42. (a) $T^2 = kd^3$
- (b) Substituting $T = 365$ and $d = 93 \times 10^6$, we get $365^2 = k \cdot (93 \times 10^6)^3 \Leftrightarrow k = 1.66 \times 10^{-19}$.
- (c) $T^2 = 1.66 \times 10^{-19} (2.79 \times 10^9)^3 = 3.60 \times 10^9 \Rightarrow T = 6.00 \times 10^4$. Hence the period of Neptune is 6.00×10^4 days ≈ 164 years.
43. (a) $P = \frac{kT}{V}$.
- (b) Substituting $P = 33.2$, $T = 400$, and $V = 100$, we get $33.2 = \frac{k(400)}{100} \Leftrightarrow k = 8.3$. Thus $k = 8.3$ and the equation is $P = \frac{8.3T}{V}$.
- (c) Substituting $T = 500$ and $V = 80$, we have $P = \frac{8.3(500)}{80} = 51.875$ kPa. Hence the pressure of the sample of gas is about 51.9 kPa.
44. (a) $F = k \frac{ws^2}{r}$
- (b) For the first car we have $w_1 = 1600$ and $s_1 = 60$ and for the second car we have $w_2 = 2500$. Since the forces are equal we have $k \frac{1600 \cdot 60^2}{r} = k \frac{2500 \cdot s_2^2}{r} \Leftrightarrow \frac{16 \cdot 60^2}{25} = s_2^2$, so $s_2 = 48$ mi/h.

45. (a) The loudness L is inversely proportional to the square of the distance d , so $L = \frac{k}{d^2}$.
- (b) Substituting $d = 10$ and $L = 70$, we have $70 = \frac{k}{10^2} \Leftrightarrow k = 7000$.
- (c) Substituting $2d$ for d , we have $L = \frac{k}{(2d)^2} = \frac{1}{4} \left(\frac{k}{d^2} \right)$, so the loudness is changed by a factor of $\frac{1}{4}$.
- (d) Substituting $\frac{1}{2}d$ for d , we have $L = \frac{k}{\left(\frac{1}{2}d\right)^2} = 4 \left(\frac{k}{d^2} \right)$, so the loudness is changed by a factor of 4.
46. (a) The power P is jointly proportional to the area A and the cube of the velocity v , so $P = kAv^3$.
- (b) Substituting $2v$ for v and $\frac{1}{2}A$ for A , we have $P = k \left(\frac{1}{2}A \right) (2v)^3 = 4kAv^3$, so the power is changed by a factor of 4.
- (c) Substituting $\frac{1}{2}v$ for v and $3A$ for A , we have $P = k(3A) \left(\frac{1}{2}v \right)^3 = \frac{3}{8}kAv^3$, so the power is changed by a factor of $\frac{3}{8}$.
47. (a) $R = \frac{kL}{d^2}$
- (b) Since $R = 140$ when $L = 1.2$ and $d = 0.005$, we get $140 = \frac{k(1.2)}{(0.005)^2} \Leftrightarrow k = \frac{7}{2400} = 0.0029\overline{16}$.
- (c) Substituting $L = 3$ and $d = 0.008$, we have $R = \frac{7}{2400} \cdot \frac{3}{(0.008)^2} = \frac{4375}{32} \approx 137 \Omega$.
- (d) If we substitute $2d$ for d and $3L$ for L , then $R = \frac{k(3L)}{(2d)^2} = \frac{3}{4} \frac{kL}{d^2}$, so the resistance is changed by a factor of $\frac{3}{4}$.
48. Let S be the final size of the cabbage, in pounds, let N be the amount of nutrients it receives, in ounces, and let c be the number of other cabbages around it. Then $S = k \frac{N}{c}$. When $N = 20$ and $c = 12$, we have $S = 30$, so substituting, we have $30 = k \frac{20}{12} \Leftrightarrow k = 18$. Thus $S = 18 \frac{N}{c}$. When $N = 10$ and $c = 5$, the final size is $S = 18 \left(\frac{10}{5} \right) = 36$ lb.
49. (a) For the sun, $E_S = k6000^4$ and for earth $E_E = k300^4$. Thus $\frac{E_S}{E_E} = \frac{k6000^4}{k300^4} = \left(\frac{6000}{300} \right)^4 = 20^4 = 160,000$. So the sun produces 160,000 times the radiation energy per unit area than the Earth.
- (b) The surface area of the sun is $4\pi (435,000)^2$ and the surface area of the Earth is $4\pi (3,960)^2$. So the sun has $\frac{4\pi (435,000)^2}{4\pi (3,960)^2} = \left(\frac{435,000}{3,960} \right)^2$ times the surface area of the Earth. Thus the total radiation emitted by the sun is $160,000 \times \left(\frac{435,000}{3,960} \right)^2 = 1,930,670,340$ times the total radiation emitted by the Earth.
50. Let V be the value of a building lot on Galiano Island, A the area of the lot, and q the quantity of the water produced. Since V is jointly proportional to the area and water quantity, we have $V = kAq$. When $A = 200 \cdot 300 = 60,000$ and $q = 10$, we have $V = \$48,000$, so $48,000 = k(60,000)(10) \Leftrightarrow k = 0.08$. Thus $V = 0.08Aq$. Now when $A = 400 \cdot 400 = 160,000$ and $q = 4$, the value is $V = 0.08(160,000)(4) = \$51,200$.
51. (a) Let T and l be the period and the length of the pendulum, respectively. Then $T = k\sqrt{l}$.
- (b) $T = k\sqrt{l} \Rightarrow T^2 = k^2l \Leftrightarrow l = \frac{T^2}{k^2}$. If the period is doubled, the new length is $\frac{(2T)^2}{k^2} = 4 \frac{T^2}{k^2} = 4l$. So we would quadruple the length l to double the period T .
52. Let H be the heat experienced by a hiker at a campfire, let A be the amount of wood, and let d be the distance from campfire. So $H = k \frac{A}{d^3}$. When the hiker is 20 feet from the fire, the heat experienced is $H = k \frac{A}{20^3}$, and when the amount of wood is doubled, the heat experienced is $H = k \frac{2A}{d^3}$. So $k \frac{2A}{8,000} = k \frac{2A}{d^3} \Leftrightarrow d^3 = 16,000 \Leftrightarrow d = 20 \sqrt[3]{2} \approx 25.2$ feet.

53. (a) Since f is inversely proportional to L , we have $f = \frac{k}{L}$, where k is a positive constant.
- (b) If we replace L by $2L$ we have $\frac{k}{2L} = \frac{1}{2} \cdot \frac{k}{L} = \frac{1}{2}f$. So the frequency of the vibration is cut in half.
54. (a) Since r is jointly proportional to x and $P - x$, we have $r = kx(P - x)$, where k is a positive constant.
- (b) When 10 people are infected the rate is $r = k(10)(5000 - 10) = 49,900k$. When 1000 people are infected the rate is $r = k \cdot 1000 \cdot (5000 - 1000) = 4,000,000k$. So the rate is much higher when 1000 people are infected. Comparing these rates, we find that $\frac{1000 \text{ people infected}}{10 \text{ people infected}} = \frac{4,000,000k}{49,900k} \approx 80$. So the infection rate when 1000 people are infected is about 80 times as large as when 10 people are infected.
- (c) When the entire population is infected the rate is $r = k(5000)(5000 - 5000) = 0$. This makes sense since there are no more people who can be infected.
55. Using $B = k\frac{L}{d^2}$ with $k = 0.080$, $L = 2.5 \times 10^{26}$, and $d = 2.4 \times 10^{19}$, we have $B = 0.080 \frac{2.5 \times 10^{26}}{(2.4 \times 10^{19})^2} \approx 3.47 \times 10^{-14}$.
- The star's apparent brightness is about 3.47×10^{-14} W/m².
56. First, we solve $B = k\frac{L}{d^2}$ for d : $d^2 = k\frac{L}{B} \Rightarrow d = \sqrt{k\frac{L}{B}}$ because d is positive. Substituting $k = 0.080$, $L = 5.8 \times 10^{30}$, and $B = 8.2 \times 10^{-16}$, we find $d = \sqrt{0.080 \frac{5.8 \times 10^{30}}{8.2 \times 10^{-16}}} \approx 2.38 \times 10^{22}$, so the star is approximately 2.38×10^{22} m from earth.
57. Examples include radioactive decay and exponential growth in biology.

CHAPTER 1 REVIEW

1. (a)

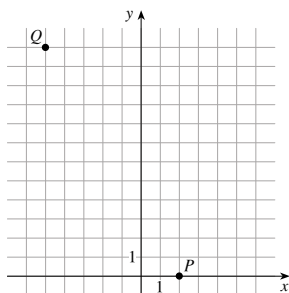

(d) The line has slope $m = \frac{12 - 0}{-5 - 2} = -\frac{12}{7}$, and has

$$\text{equation } y - 0 = -\frac{12}{7}(x - 2) \Leftrightarrow y = -\frac{12}{7}x + \frac{24}{7}$$

$$\Leftrightarrow 12x + 7y - 24 = 0.$$

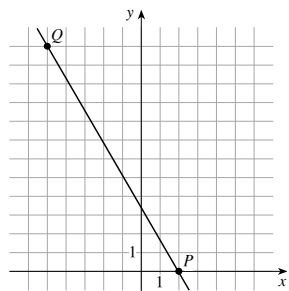

(b) The distance from P to Q is

$$\begin{aligned} d(P, Q) &= \sqrt{(-5 - 2)^2 + (12 - 0)^2} \\ &= \sqrt{49 + 144} = \sqrt{193} \end{aligned}$$

(c) The midpoint is $\left(\frac{-5 + 2}{2}, \frac{12 + 0}{2}\right) = \left(-\frac{3}{2}, 6\right)$.

(e) The radius of this circle was found in part (b). It is

$$r = d(P, Q) = \sqrt{193}. \text{ So an equation is}$$

$$(x - 2)^2 + (y - 0)^2 = (\sqrt{193})^2 \Leftrightarrow (x - 2)^2 + y^2 = 193.$$

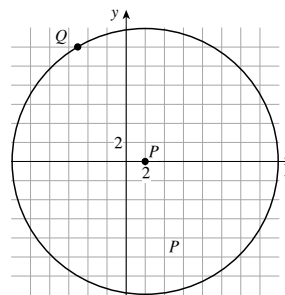

2. (a)

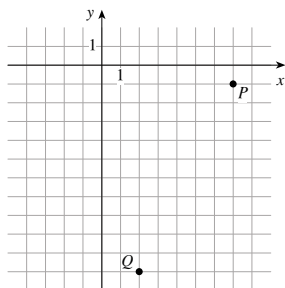

(d) The line has slope $m = \frac{-11 + 1}{2 - 7} = \frac{-10}{-5} = 2$, and its equation is $y + 11 = 2(x - 2) \Leftrightarrow y + 11 = 2x - 4 \Leftrightarrow y = 2x - 15$.

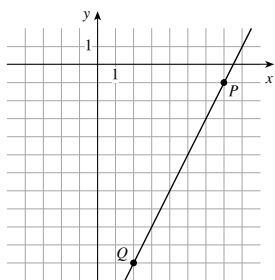

(b) The distance from P to Q is

$$\begin{aligned} d(P, Q) &= \sqrt{(2 - 7)^2 + (-11 + 1)^2} \\ &= \sqrt{25 + 100} = \sqrt{125} = 5\sqrt{5} \end{aligned}$$

(c) The midpoint is $\left(\frac{2+7}{2}, \frac{-11-1}{2}\right) = \left(\frac{9}{2}, -6\right)$.

(e) The radius of this circle was found in part (b). It is

$$r = d(P, Q) = 5\sqrt{5}. \text{ So an equation is}$$

$$(x - 7)^2 + (y + 1)^2 = (5\sqrt{5})^2 \Leftrightarrow$$

$$(x - 7)^2 + (y + 1)^2 = 125.$$

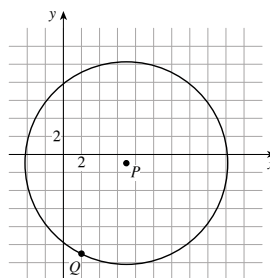

3. (a)

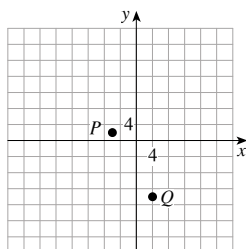

(d) The line has slope $m = \frac{2 - (-14)}{-6 - 4} = \frac{16}{-10} = -\frac{8}{5}$ and equation $y - 2 = -\frac{8}{5}(x + 6) \Leftrightarrow y - 2 = -\frac{8}{5}x - \frac{48}{5} \Leftrightarrow y = -\frac{8}{5}x - \frac{38}{5}$.

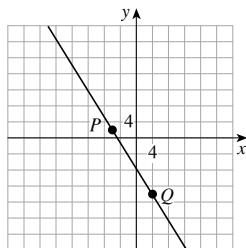

(b) The distance from P to Q is

$$\begin{aligned} d(P, Q) &= \sqrt{(-6 - 4)^2 + [2 - (-14)]^2} \\ &= \sqrt{100 + 256} = \sqrt{356} = 2\sqrt{89} \end{aligned}$$

(c) The midpoint is $\left(\frac{-6+4}{2}, \frac{2+(-14)}{2}\right) = (-1, -6)$.

(e) The radius of this circle was found in part (b). It is

$$r = d(P, Q) = 2\sqrt{89}. \text{ So an equation is}$$

$$[x - (-6)]^2 + (y - 2)^2 = (2\sqrt{89})^2 \Leftrightarrow$$

$$(x + 6)^2 + (y - 2)^2 = 356.$$

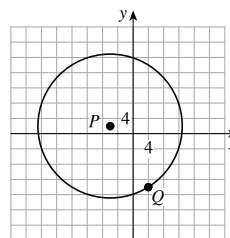

4. (a)

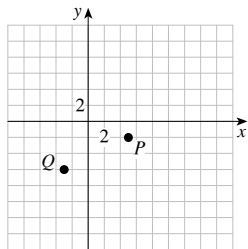
 (d) The line has slope $m = \frac{-2 - (-6)}{5 - (-3)} = \frac{4}{8} = \frac{1}{2}$, and

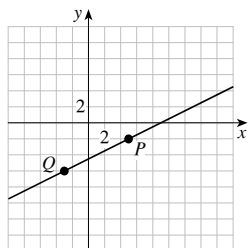
 has equation $y - (-2) = \frac{1}{2}(x - 5) \Leftrightarrow$
 $y + 2 = \frac{1}{2}x - \frac{5}{2} \Leftrightarrow y = \frac{1}{2}x - \frac{9}{2}.$

 (b) The distance from P to Q is

$$\begin{aligned} d(P, Q) &= \sqrt{[5 - (-3)]^2 + [-2 - (-6)]^2} \\ &= \sqrt{64 + 16} = \sqrt{80} = 4\sqrt{5}. \end{aligned}$$

 (c) The midpoint is $\left(\frac{5 + (-3)}{2}, \frac{-2 + (-6)}{2}\right) = (1, -4).$

(e) The radius of this circle was found in part (b). It is

 $r = d(P, Q) = 4\sqrt{5}.$ So an equation is

$$(x - 5)^2 + [y - (-2)]^2 = (4\sqrt{5})^2 \Leftrightarrow$$

$$(x - 5)^2 + (y + 2)^2 = 80.$$

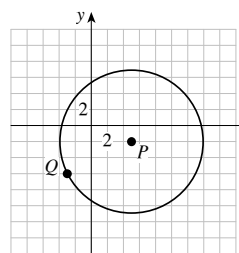

5.

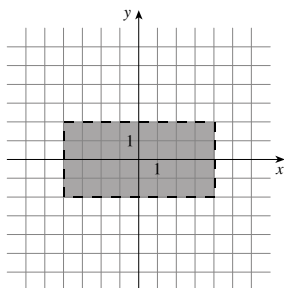
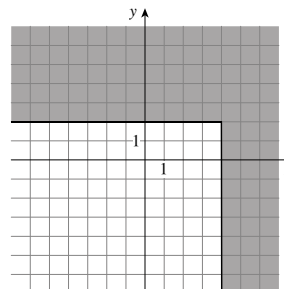
 6. $\{(x, y) \mid x \geq 4 \text{ or } y \geq 2\}$

 7. $d(A, C) = \sqrt{(4 - (-1))^2 + (4 - (-3))^2} = \sqrt{(4 + 1)^2 + (4 + 3)^2} = \sqrt{74}$ and

 $d(B, C) = \sqrt{(5 - (-1))^2 + (3 - (-3))^2} = \sqrt{(5 + 1)^2 + (3 + 3)^2} = \sqrt{72}.$ Therefore, B is closer to C .

 8. The circle with center at $(2, -5)$ and radius $\sqrt{2}$ has equation $(x - 2)^2 + (y + 5)^2 = (\sqrt{2})^2 \Leftrightarrow (x - 2)^2 + (y + 5)^2 = 2.$

 9. The center is $C = (-5, -1)$, and the point $P = (0, 0)$ is on the circle. The radius of the circle is

 $r = d(P, C) = \sqrt{(0 - (-5))^2 + (0 - (-1))^2} = \sqrt{(0 + 5)^2 + (0 + 1)^2} = \sqrt{26}.$ Thus, the equation of the circle is

$$(x + 5)^2 + (y + 1)^2 = 26.$$

 10. The midpoint of segment PQ is $\left(\frac{2 - 1}{2}, \frac{3 + 8}{2}\right) = \left(\frac{1}{2}, \frac{11}{2}\right)$, and the radius is $\frac{1}{2}$ of the distance from P to Q , or

 $r = \frac{1}{2} \cdot d(P, Q) = \frac{1}{2} \sqrt{(2 - (-1))^2 + (3 - 8)^2} = \frac{1}{2} \sqrt{(2 + 1)^2 + (3 - 8)^2} \Leftrightarrow r = \frac{1}{2} \sqrt{34}.$ Thus the equation is

$$\left(x - \frac{1}{2}\right)^2 + \left(y - \frac{11}{2}\right)^2 = \frac{17}{2}.$$

11. (a) $x^2 + y^2 + 2x - 6y + 9 = 0 \Leftrightarrow (x^2 + 2x) + (y^2 - 6y) = -9 \Leftrightarrow$
 $(x^2 + 2x + 1) + (y^2 - 6y + 9) = -9 + 1 + 9 \Leftrightarrow$
 $(x + 1)^2 + (y - 3)^2 = 1$, an equation of a circle.

(b) The circle has center $(-1, 3)$ and radius 1.

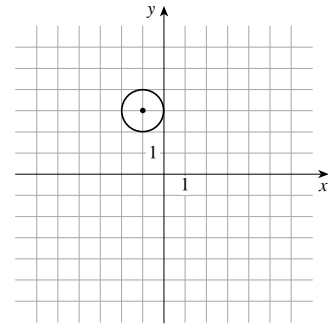

12. (a) $2x^2 + 2y^2 - 2x + 8y = \frac{1}{2} \Leftrightarrow x^2 - x + y^2 + 4y = \frac{1}{4} \Leftrightarrow$
 $(x^2 - x + \frac{1}{4}) + (y^2 + 4y + 4) = \frac{1}{4} + \frac{1}{4} + 4 \Leftrightarrow$
 $(x - \frac{1}{2})^2 + (y + 2)^2 = \frac{9}{2}$, an equation of a circle.

(b) The circle has center $(\frac{1}{2}, -2)$ and radius $\frac{3\sqrt{2}}{2}$.

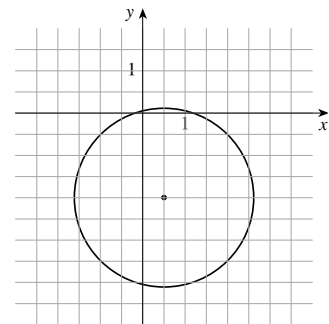

13. (a) $x^2 + y^2 + 72 = 12x \Leftrightarrow (x^2 - 12x) + y^2 = -72 \Leftrightarrow (x^2 - 12x + 36) + y^2 = -72 + 36 \Leftrightarrow (x - 6)^2 + y^2 = -36$.
 Since the left side of this equation must be greater than or equal to zero, this equation has no graph.

14. (a) $x^2 + y^2 - 6x - 10y + 34 = 0 \Leftrightarrow x^2 - 6x + y^2 - 10y = -34 \Leftrightarrow$
 $(x^2 - 6x + 9) + (y^2 - 10y + 25) = -34 + 9 + 25 \Leftrightarrow$
 $(x - 3)^2 + (y - 5)^2 = 0$, an equation of a point.

(b) This is the equation of the point $(3, 5)$.

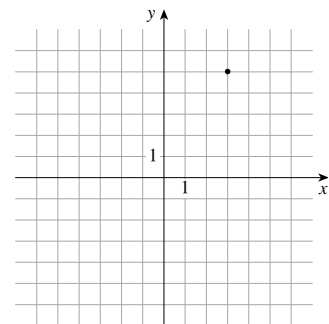

15. $y = 2 - 3x$

x	y
-2	8
0	2
$\frac{2}{3}$	0

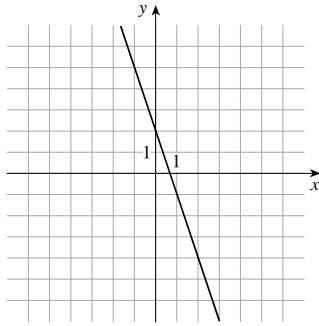

16. $2x - y + 1 = 0 \Leftrightarrow y = 2x + 1$

x	y
-2	-3
0	1
$-\frac{1}{2}$	0

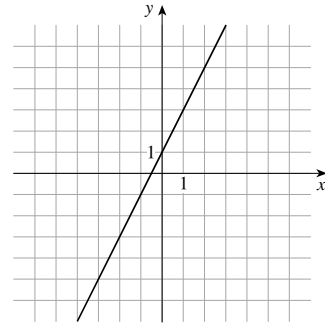

17. $\frac{x}{2} - \frac{y}{7} = 1 \Leftrightarrow y = \frac{7}{2}x - 7$

x	y
-2	-14
0	-7
2	0

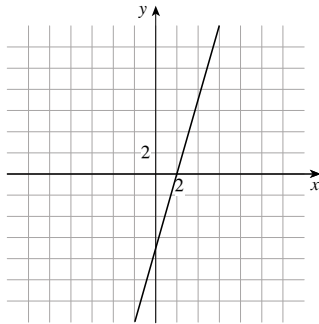

18. $\frac{x}{4} + \frac{y}{5} = 0 \Leftrightarrow 5x + 4y = 0$

x	y
-4	5
0	0
4	-5

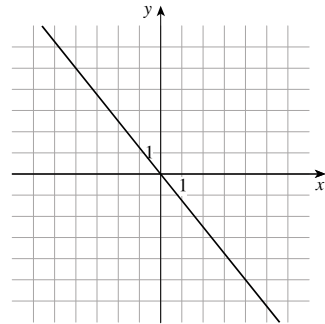

19. $y = 16 - x^2$

x	y
-3	7
-1	15
0	16
1	15
3	7

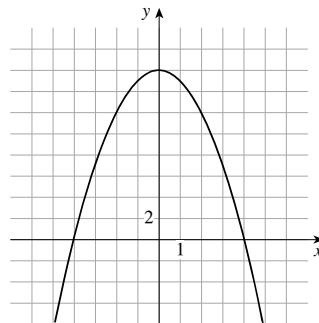

20. $8x + y^2 = 0 \Leftrightarrow y^2 = -8x$

x	y
-8	± 8
-2	± 4
0	0

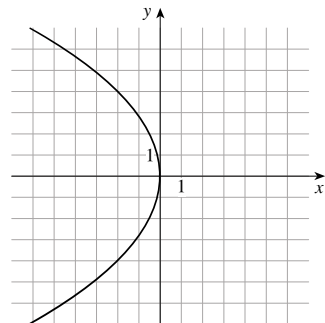

21. $x = \sqrt{y}$

x	y
0	0
1	1
2	4
3	9

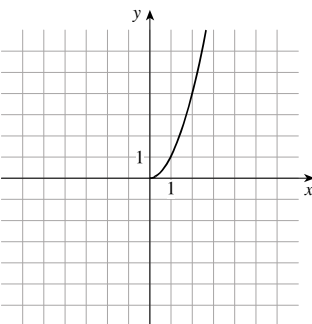

22. $y = -\sqrt{1 - x^2}$

x	y
-1	0
$\frac{1}{2}$	$-\frac{\sqrt{3}}{2}$
0	-1
1	0

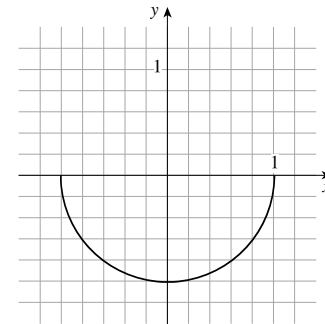

23. $y = 9 - x^2$

(a) x -axis symmetry: replacing y by $-y$ gives $-y = 9 - x^2$, which is not the same as the original equation, so the graph is not symmetric about the x -axis.

y -axis symmetry: replacing x by $-x$ gives $y = 9 - (-x)^2 = 9 - x^2$, which is the same as the original equation, so the graph is symmetric about the y -axis.

Origin symmetry: replacing x by $-x$ and y by $-y$ gives $-y = 9 - (-x)^2 \Leftrightarrow y = -9 + x^2$, which is not the same as the original equation, so the graph is not symmetric about the origin.

(b) To find x -intercepts, we set $y = 0$ and solve for x : $0 = 9 - x^2 \Leftrightarrow x^2 = 9 \Leftrightarrow x = \pm 3$, so the x -intercepts are -3 and 3 .

To find y -intercepts, we set $x = 0$ and solve for y : $y = 9 - 0^2 = 9$, so the y -intercept is 9 .

24. $6x + y^2 = 36$

(a) x -axis symmetry: replacing y by $-y$ gives $6x + (-y)^2 = 36 \Leftrightarrow 6x + y^2 = 36$, which is the same as the original equation, so the graph is symmetric about the x -axis.

y -axis symmetry: replacing x by $-x$ gives $6(-x) + y^2 = 36 \Leftrightarrow -6x + y^2 = 36$, which is not the same as the original equation, so the graph is not symmetric about the y -axis.

Origin symmetry: replacing x by $-x$ and y by $-y$ gives $6(-x) + (-y)^2 = 36 \Leftrightarrow -6x + y^2 = 36$, which is not the same as the original equation, so the graph is not symmetric about the origin.

(b) To find x -intercepts, we set $y = 0$ and solve for x : $6x + 0^2 = 36 \Leftrightarrow x = 6$, so the x -intercept is 6 .

To find y -intercepts, we set $x = 0$ and solve for y : $6(0) + y^2 = 36 \Leftrightarrow y = \pm 6$, so the y -intercepts are -6 and 6 .

25. $x^2 + (y - 1)^2 = 1$

(a) x -axis symmetry: replacing y by $-y$ gives $x^2 + [(-y) - 1]^2 = 1 \Leftrightarrow x^2 + (y + 1)^2 = 1$, so the graph is not symmetric about the x -axis.

y -axis symmetry: replacing x by $-x$ gives $(-x)^2 + (y - 1)^2 = 1 \Leftrightarrow x^2 + (y - 1)^2 = 1$, so the graph is symmetric about the y -axis.

Origin symmetry: replacing x by $-x$ and y by $-y$ gives $(-x)^2 + [(-y) - 1]^2 = 1 \Leftrightarrow x^2 + (y + 1)^2 = 1$, so the graph is not symmetric about the origin.

(b) To find x -intercepts, we set $y = 0$ and solve for x : $x^2 + (0 - 1)^2 = 1 \Leftrightarrow x^2 = 0$, so the x -intercept is 0 .

To find y -intercepts, we set $x = 0$ and solve for y : $0^2 + (y - 1)^2 = 1 \Leftrightarrow y - 1 = \pm 1 \Leftrightarrow y = 0$ or 2 , so the y -intercepts are 0 and 2 .

26. $x^4 = 16 + y$

(a) x -axis symmetry: replacing y by $-y$ gives $x^4 = 16 + (-y) \Leftrightarrow x^4 = 16 - y$, so the graph is not symmetric about the x -axis.

y -axis symmetry: replacing x by $-x$ gives $(-x)^4 = 16 + y \Leftrightarrow x^4 = 16 + y$, so the graph is symmetric about the y -axis.

Origin symmetry: replacing x by $-x$ and y by $-y$ gives $(-x)^4 = 16 + (-y) \Leftrightarrow x^4 = 16 - y$, so the graph is not symmetric about the origin.

(b) To find x -intercepts, we set $y = 0$ and solve for x : $x^4 = 16 + 0 \Leftrightarrow x^4 = 16 \Leftrightarrow x = \pm 2$, so the x -intercepts are -2 and 2 .

To find y -intercepts, we set $x = 0$ and solve for y : $0^4 = 16 + y \Leftrightarrow y = -16$, so the y -intercept is -16 .

27. $9x^2 - 16y^2 = 144$

(a) x -axis symmetry: replacing y by $-y$ gives $9x^2 - 16(-y)^2 = 144 \Leftrightarrow 9x^2 - 16y^2 = 144$, so the graph is symmetric about the x -axis.

y -axis symmetry: replacing x by $-x$ gives $9(-x)^2 - 16y^2 = 144 \Leftrightarrow 9x^2 - 16y^2 = 144$, so the graph is symmetric about the y -axis.

Origin symmetry: replacing x by $-x$ and y by $-y$ gives $9(-x)^2 - 16(-y)^2 = 144 \Leftrightarrow 9x^2 - 16y^2 = 144$, so the graph is symmetric about the origin.

(b) To find x -intercepts, we set $y = 0$ and solve for x : $9x^2 - 16(0)^2 = 144 \Leftrightarrow 9x^2 = 144 \Leftrightarrow x = \pm 4$, so the x -intercepts are -4 and 4 .

To find y -intercepts, we set $x = 0$ and solve for y : $9(0)^2 - 16y^2 = 144 \Leftrightarrow 16y^2 = -144$, so there is no y -intercept.

28. $y = \frac{4}{x}$

(a) x -axis symmetry: replacing y by $-y$ gives $-y = \frac{4}{x}$, which is different from the original equation, so the graph is not symmetric about the x -axis.

y -axis symmetry: replacing x by $-x$ gives $y = \frac{4}{-x}$, which is different from the original equation, so the graph is not symmetric about the y -axis.

Origin symmetry: replacing x by $-x$ and y by $-y$ gives $-y = \frac{4}{-x} \Leftrightarrow y = \frac{4}{x}$, so the graph is symmetric about the origin.

(b) To find x -intercepts, we set $y = 0$ and solve for x : $0 = \frac{4}{x}$ has no solution, so there is no x -intercept.

To find y -intercepts, we set $x = 0$ and solve for y . But we cannot substitute $x = 0$, so there is no y -intercept.

29. $x^2 + 4xy + y^2 = 1$

(a) x -axis symmetry: replacing y by $-y$ gives $x^2 + 4x(-y) + (-y)^2 = 1$, which is different from the original equation, so the graph is not symmetric about the x -axis.

y -axis symmetry: replacing x by $-x$ gives $(-x)^2 + 4(-x)y + y^2 = 1$, which is different from the original equation, so the graph is not symmetric about the y -axis.

Origin symmetry: replacing x by $-x$ and y by $-y$ gives $(-x)^2 + 4(-x)(-y) + (-y)^2 = 1 \Leftrightarrow x^2 + 4xy + y^2 = 1$, so the graph is symmetric about the origin.

(b) To find x -intercepts, we set $y = 0$ and solve for x : $x^2 + 4x(0) + 0^2 = 1 \Leftrightarrow x^2 = 1 \Leftrightarrow x = \pm 1$, so the x -intercepts are -1 and 1 .

To find y -intercepts, we set $x = 0$ and solve for y : $0^2 + 4(0)y + y^2 = 1 \Leftrightarrow y^2 = 1 \Leftrightarrow y = \pm 1$, so the y -intercepts are -1 and 1 .

30. $x^3 + xy^2 = 5$

(a) x -axis symmetry: replacing y by $-y$ gives $x^3 + x(-y)^2 = 5 \Leftrightarrow x^3 + xy^2 = 5$, so the graph is symmetric about the x -axis.

y -axis symmetry: replacing x by $-x$ gives $(-x)^3 + (-x)y^2 = 5$, which is different from the original equation, so the graph is not symmetric about the y -axis.

Origin symmetry: replacing x by $-x$ and y by $-y$ gives $(-x)^3 + (-x)(-y)^2 = 5$, which is different from the original equation, so the graph is not symmetric about the origin.

(b) To find x -intercepts, we set $y = 0$ and solve for x : $x^3 + x(0)^2 = 5 \Leftrightarrow x^3 = 5 \Leftrightarrow x = \sqrt[3]{5}$, so the x -intercept is $\sqrt[3]{5}$.

To find y -intercepts, we set $x = 0$ and solve for y : $0^3 + 0y^2 = 5$ has no solution, so there is no y -intercept.

31. (a) We graph $y = x^2 - 6x$ in the viewing rectangle $[-10, 10]$ by $[-10, 10]$.

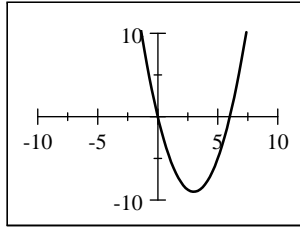

- (b) From the graph, we see that the x -intercepts are 0 and 6 and the y -intercept is 0.

32. (a) We graph $y = \sqrt{5-x}$ in the viewing rectangle $[-10, 6]$ by $[-1, 5]$.

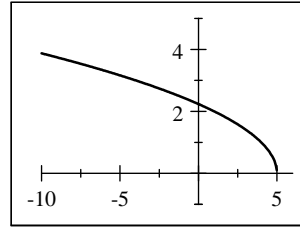

- (b) From the graph, we see that the x -intercept is 5 and the y -intercept is approximately 2.24.

33. (a) We graph $y = x^3 - 4x^2 - 5x$ in the viewing rectangle $[-4, 8]$ by $[-30, 20]$.

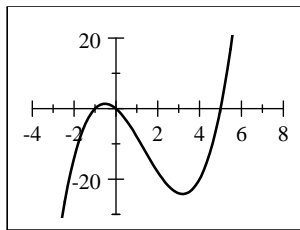

- (b) From the graph, we see that the x -intercepts are -1 , 0 , and 5 and the y -intercept is 0 .

34. (a) We graph $\frac{x^2}{4} + y^2 = 1 \Leftrightarrow y^2 = 1 - \frac{x^2}{4} \Rightarrow y = \pm\sqrt{1 - \frac{x^2}{4}}$ in the viewing rectangle $[-3, 3]$ by $[-2, 2]$.

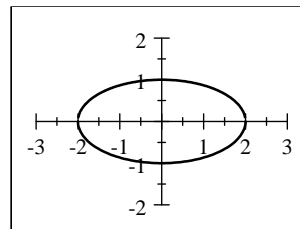

- (b) From the graph, we see that the x -intercepts are -2 and 2 and the y -intercepts are -1 and 1 .

35. (a) The line that has slope 2 and y -intercept 6 has the slope-intercept equation (c) $y = 2x + 6$.

- (b) An equation of the line in general form is $2x - y + 6 = 0$.

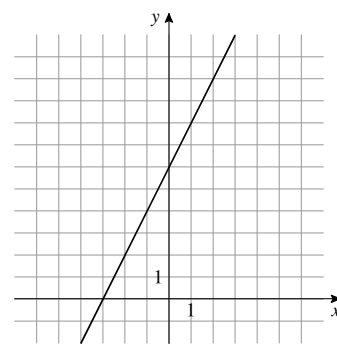

36. (a) The line that has slope $-\frac{1}{2}$ and passes through the point $(6, -3)$ has equation $y - (-3) = -\frac{1}{2}(x - 6) \Leftrightarrow y + 3 = -\frac{1}{2}(x - 6) \Leftrightarrow y = -\frac{1}{2}x$.

(b) $-\frac{1}{2}x + 3 = y + 3 \Leftrightarrow x - 6 = -2y - 6 \Leftrightarrow x + 2y = 0$.

(c)

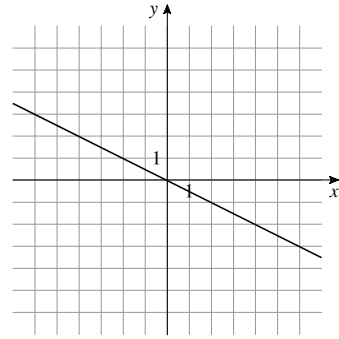

37. (a) The line that passes through the points $(-1, -6)$ and $(2, -4)$ has slope

$$m = \frac{-4 - (-6)}{2 - (-1)} = \frac{2}{3}, \text{ so } y - (-6) = \frac{2}{3}[x - (-1)] \Leftrightarrow y + 6 = \frac{2}{3}x + \frac{2}{3}$$

$$\Leftrightarrow y = \frac{2}{3}x - \frac{16}{3}.$$

(b) $y = \frac{2}{3}x - \frac{16}{3} \Leftrightarrow 3y = 2x - 16 \Leftrightarrow 2x - 3y - 16 = 0$.

(c)

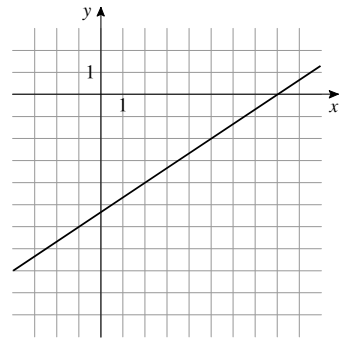

38. (a) The line that has x -intercept 4 and y -intercept 12 passes through the points

$(4, 0)$ and $(0, 12)$, so $m = \frac{12 - 0}{0 - 4} = -3$ and the equation is

$$y - 0 = -3(x - 4) \Leftrightarrow y = -3x + 12.$$

(b) $y = -3x + 12 \Leftrightarrow 3x + y - 12 = 0$.

(c)

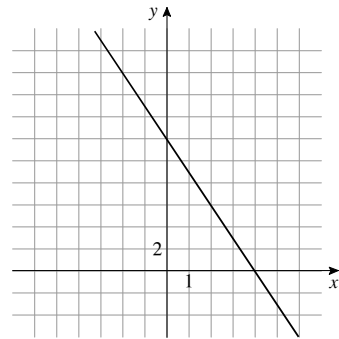

39. (a) The vertical line that passes through the point $(3, -2)$ has equation $x = 3$.

(b) $x = 3 \Leftrightarrow x - 3 = 0$.

(c)

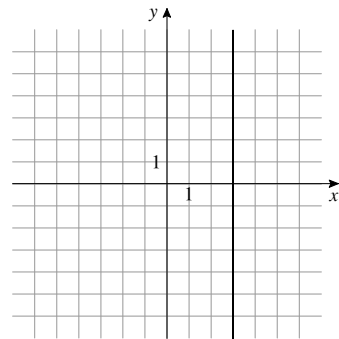

40. (a) The horizontal line with y -intercept 5 has equation $y = 5$.

(b) $y = 5 \Leftrightarrow y - 5 = 0$.

(c)

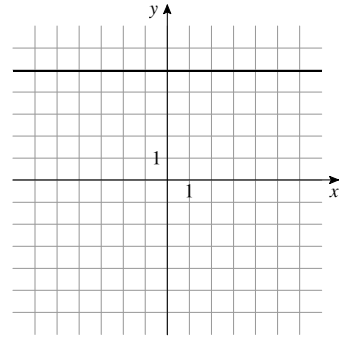

41. (a) $2x - 5y = 10 \Leftrightarrow 5y = 2x - 10 \Leftrightarrow y = \frac{2}{5}x - 2$, so the given line has slope $m = \frac{2}{5}$. Thus, an equation of the line passing through $(1, 1)$ parallel to this

line is $y - 1 = \frac{2}{5}(x - 1) \Leftrightarrow y = \frac{2}{5}x + \frac{3}{5}$.

(b) $y = \frac{2}{5}x + \frac{3}{5} \Leftrightarrow 5y = 2x + 3 \Leftrightarrow 2x - 5y + 3 = 0$.

(c)

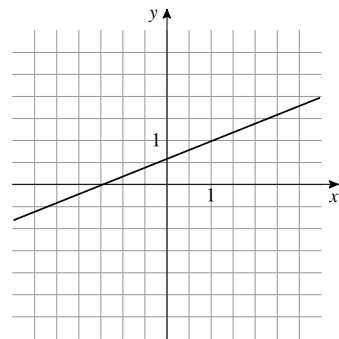

42. (a) The line containing $(2, 4)$ and $(4, -4)$ has slope

$$m = \frac{-4 - 4}{4 - 2} = \frac{-8}{2} = -4, \text{ and the line passing through the origin with}$$

this slope has equation $y = -4x$.

(b) $y = -4x \Leftrightarrow 4x + y = 0$.

(c)

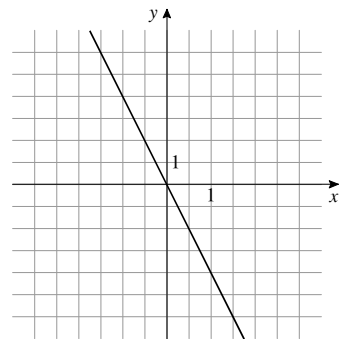

43. (a) The line $y = \frac{1}{2}x - 10$ has slope $\frac{1}{2}$, so a line perpendicular to this one has slope $-\frac{1}{1/2} = -2$. In particular, the line passing through the origin perpendicular to the given line has equation $y = -2x$.

(b) $y = -2x \Leftrightarrow 2x + y = 0$.

(c)

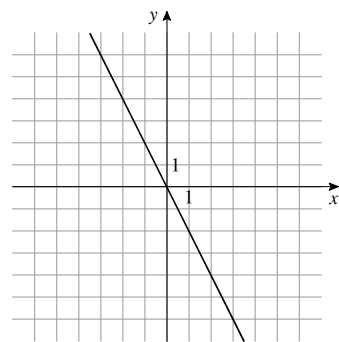

44. (a) $x - 3y + 16 = 0 \Leftrightarrow 3y = x + 16 \Leftrightarrow y = \frac{1}{3}x + \frac{16}{3}$, so the given line has (c)

slope $\frac{1}{3}$. The line passing through $(1, 7)$ perpendicular to the given line has

$$\text{equation } y - 7 = -\frac{1}{1/3}(x - 1) \Leftrightarrow y - 7 = -3(x - 1) \Leftrightarrow y = -3x + 10.$$

(b) $y = -3x + 10 \Leftrightarrow 3x + y - 10 = 0.$

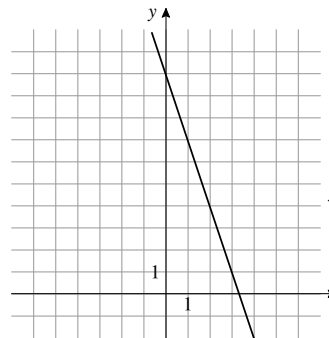

45. The line with equation $y = -\frac{1}{3}x - 1$ has slope $-\frac{1}{3}$. The line with equation $9y + 3x + 3 = 0 \Leftrightarrow 9y = -3x - 3 \Leftrightarrow y = -\frac{1}{3}x - \frac{1}{3}$ also has slope $-\frac{1}{3}$, so the lines are parallel.
46. The line with equation $5x - 8y = 3 \Leftrightarrow 8y = 5x - 3 \Leftrightarrow y = \frac{5}{8}x - \frac{3}{8}$ has slope $\frac{5}{8}$. The line with equation $10y + 16x = 1 \Leftrightarrow 10y = -16x + 1 \Leftrightarrow y = -\frac{8}{5}x + \frac{1}{10}$ has slope $-\frac{8}{5} = -\frac{1}{5/8}$, so the lines are perpendicular.
47. (a) The slope represents a stretch of 0.3 inches for each one-pound increase in weight. The s -intercept represents the length of the unstretched spring.
- (b) When $w = 5$, $s = 0.3(5) + 2.5 = 1.5 + 2.5 = 4.0$ inches.
48. (a) We use the information to find two points, $(0, 60000)$ and $(3, 70500)$. Then the slope is
- $$m = \frac{70,500 - 60,000}{3 - 0} = \frac{10,500}{3} = 3,500. \text{ So } S = 3,500t + 60,000.$$
- (b) The slope represents an annual salary increase of \$3500, and the S -intercept represents her initial salary.
- (c) When $t = 12$, her salary will be $S = 3500(12) + 60,000 = 42,000 + 60,000 = \$102,000$.
49. $x^2 - 9x + 14 = 0 \Leftrightarrow (x - 7)(x - 2) = 0 \Leftrightarrow x = 7$ or $x = 2$.
50. $x^2 + 24x + 144 = 0 \Leftrightarrow (x + 12)^2 = 0 \Leftrightarrow x + 12 = 0 \Leftrightarrow x = -12$.
51. $2x^2 + x = 1 \Leftrightarrow 2x^2 + x - 1 = 0 \Leftrightarrow (2x - 1)(x + 1) = 0$. So either $2x - 1 = 0 \Leftrightarrow 2x = 1 \Leftrightarrow x = \frac{1}{2}$; or $x + 1 = 0 \Leftrightarrow x = -1$.
52. $3x^2 + 5x - 2 = 0 \Leftrightarrow (3x - 1)(x + 2) = 0 \Leftrightarrow x = \frac{1}{3}$ or $x = -2$.
53. $0 = 4x^3 - 25x = x(4x^2 - 25) = x(2x - 5)(2x + 5) = 0$. So either $x = 0$; or $2x - 5 = 0 \Leftrightarrow 2x = 5 \Leftrightarrow x = \frac{5}{2}$; or $2x + 5 = 0 \Leftrightarrow 2x = -5 \Leftrightarrow x = -\frac{5}{2}$.
54. $x^3 - 2x^2 - 5x + 10 = 0 \Leftrightarrow x^2(x - 2) - 5(x - 2) = 0 \Leftrightarrow (x - 2)(x^2 - 5) = 0 \Leftrightarrow x = 2$ or $x = \pm\sqrt{5}$.
55. $3x^2 + 4x - 1 = 0 \Rightarrow$
- $$x = \frac{-b \pm \sqrt{b^2 - 4ac}}{2a} = \frac{-4 \pm \sqrt{4^2 - 4(3)(-1)}}{2(-3)} = \frac{-4 \pm \sqrt{16 + 12}}{-6} = \frac{-4 \pm \sqrt{28}}{-6} = \frac{-4 \pm 2\sqrt{7}}{6} = \frac{2(-2 \pm \sqrt{7})}{-6} = \frac{-2 \pm \sqrt{7}}{3}.$$
56. $x^2 - 3x + 9 = 0 \Rightarrow x = \frac{-b \pm \sqrt{b^2 - 4ac}}{2a} = \frac{-(-3) \pm \sqrt{(-3)^2 - 4(1)(9)}}{2(1)} = \frac{3 \pm \sqrt{9 - 36}}{2} = \frac{3 \pm \sqrt{-27}}{2}$, which are not real numbers.
- There is no real solution.
57. $\frac{1}{x} + \frac{2}{x-1} = 3 \Leftrightarrow (x-1) + 2(x) = 3(x)(x-1) \Leftrightarrow x-1 + 2x = 3x^2 - 3x \Leftrightarrow 0 = 3x^2 - 6x + 1 \Rightarrow$
- $$x = \frac{-b \pm \sqrt{b^2 - 4ac}}{2a} = \frac{-(-6) \pm \sqrt{(-6)^2 - 4(3)(1)}}{2(3)} = \frac{6 \pm \sqrt{36 - 12}}{6} = \frac{6 \pm \sqrt{24}}{6} = \frac{6 \pm 2\sqrt{6}}{6} = \frac{2(3 \pm \sqrt{6})}{6} = \frac{3 \pm \sqrt{6}}{3}.$$
58. $\frac{x}{x-2} + \frac{1}{x+2} = \frac{8}{x^2-4} \Leftrightarrow x(x+2) + (x-2) = 8 \Leftrightarrow x^2 + 2x + x - 2 = 8 \Leftrightarrow x^2 + 3x - 10 = 0 \Leftrightarrow (x-2)(x+5) = 0$
 $\Leftrightarrow x = 2$ or $x = -5$. However, since $x = 2$ makes the expression undefined, we reject this solution. Hence the only solution is $x = -5$.

59. $x^4 - 8x^2 - 9 = 0 \Leftrightarrow (x^2 - 9)(x^2 + 1) = 0 \Leftrightarrow (x - 3)(x + 3)(x^2 + 1) = 0 \Rightarrow x - 3 = 0 \Leftrightarrow x = 3$, or $x + 3 = 0 \Leftrightarrow x = -3$, however $x^2 + 1 = 0$ has no real solution. The solutions are $x = \pm 3$.
60. $x - 4\sqrt{x} = 32$. Let $u = \sqrt{x}$. Then $u^2 - 4u = 32 \Leftrightarrow u^2 - 4u - 32 = 0 \Leftrightarrow (u - 8)(u + 4) = 0$ So either $u - 8 = 0$ or $u + 4 = 0$. If $u - 8 = 0$, then $u = 8 \Leftrightarrow \sqrt{x} = 8 \Leftrightarrow x = 64$. If $u + 4 = 0$, then $u = -4 \Leftrightarrow \sqrt{x} = -4$, which has no real solution. So the only solution is $x = 64$.
61. $x^{-1/2} - 2x^{1/2} + x^{3/2} = 0 \Leftrightarrow x^{-1/2}(1 - 2x + x^2) = 0 \Leftrightarrow x^{-1/2}(1 - x)^2 = 0$. Since $x^{-1/2} - 1/\sqrt{x}$ is never 0, the only solution comes from $(1 - x)^2 = 0 \Leftrightarrow 1 - x = 0 \Leftrightarrow x = 1$.
62. $(1 + \sqrt{x})^2 - 2(1 + \sqrt{x}) - 15 = 0$. Let $u = 1 + \sqrt{x}$, then the equation becomes $u^2 - 2u - 15 = 0 \Leftrightarrow (u - 5)(u + 3) = 0 \Leftrightarrow u - 5 = 0$ or $u + 3 = 0$. If $u - 5 = 0$, then $u = 5 \Leftrightarrow 1 + \sqrt{x} = 5 \Leftrightarrow \sqrt{x} = 4 \Leftrightarrow x = 16$. If $u + 3 = 0$, then $u = -3 \Leftrightarrow 1 + \sqrt{x} = -3 \Leftrightarrow \sqrt{x} = -4$, which has no real solution. So the only solution is $x = 16$.
63. $|x - 7| = 4 \Leftrightarrow x - 7 = \pm 4 \Leftrightarrow x = 7 \pm 4$, so $x = 11$ or $x = 3$.
64. $|2x - 5| = 9$ is equivalent to $2x - 5 = \pm 9 \Leftrightarrow 2x = 5 \pm 9 \Leftrightarrow x = \frac{5 \pm 9}{2}$. So $x = -2$ or $x = 7$.
65. (a) $(2 - 3i) + (1 + 4i) = (2 + 1) + (-3 + 4)i = 3 + i$
 (b) $(2 + i)(3 - 2i) = 6 - 4i + 3i - 2i^2 = 6 - i + 2 = 8 - i$
66. (a) $(3 - 6i) - (6 - 4i) = 3 - 6i - 6 + 4i = (3 - 6) + (-6 + 4)i = -3 - 2i$
 (b) $4i\left(2 - \frac{1}{2}i\right) = 8i - 2i^2 = 8i + 2 = 2 + 8i$
67. (a) $\frac{4 + 2i}{2 - i} = \frac{4 + 2i}{2 - i} \cdot \frac{2 + i}{2 + i} = \frac{8 + 8i + 2i^2}{4 - i^2} = \frac{8 + 8i - 2}{4 + 1} = \frac{6 + 8i}{5} = \frac{6}{5} + \frac{8}{5}i$
 (b) $(1 - \sqrt{-1})(1 + \sqrt{-1}) = (1 - i)(1 + i) = 1 + i - i - i^2 = 1 + 1 = 2$
68. (a) $\frac{8 + 3i}{4 + 3i} = \frac{8 + 3i}{4 + 3i} \cdot \frac{4 - 3i}{4 - 3i} = \frac{32 - 12i - 9i^2}{16 - 9i^2} = \frac{32 - 12i + 9}{16 + 9} = \frac{41 - 12i}{25} = \frac{41}{25} - \frac{12}{25}i$
 (b) $\sqrt{-10} \cdot \sqrt{-40} = i\sqrt{10} \cdot 2i\sqrt{10} = 20i^2 = -20$
69. $x^2 + 16 = 0 \Leftrightarrow x^2 = -16 \Leftrightarrow x = \pm 4i$
70. $x^2 = -12 \Leftrightarrow x = \pm\sqrt{-12} = \pm 2\sqrt{3}i$
71. $x^2 + 6x + 10 = 0 \Leftrightarrow x = \frac{-b \pm \sqrt{b^2 - 4ac}}{2a} = \frac{-6 \pm \sqrt{6^2 - 4(1)(10)}}{2(1)} = \frac{-6 \pm \sqrt{36 - 40}}{2} = -3 \pm i$
72. $2x^2 - 3x + 2 = 0 \Leftrightarrow x = \frac{-(-3) \pm \sqrt{(-3)^2 - 4(2)(2)}}{2(2)} = \frac{3 \pm \sqrt{-7}}{4} = \frac{3}{4} \pm \frac{\sqrt{7}}{4}i$
73. $x^4 - 256 = 0 \Leftrightarrow (x^2 - 16)(x^2 + 16) = 0 \Leftrightarrow x = \pm 4$ or $x = \pm 4i$
74. $x^3 - 2x^2 + 4x - 8 = 0 \Leftrightarrow (x - 2)(x^2 + 4) \Leftrightarrow x = 2$ or $x = \pm 2i$

75. Let r be the rate the woman runs in mi/h. Then she cycles at $r + 8$ mi/h.

	Rate	Time	Distance
Cycle	$r + 8$	$\frac{4}{r + 8}$	4
Run	r	$\frac{2.5}{r}$	2.5

Since the total time of the workout is 1 hour, we have $\frac{4}{r + 8} + \frac{2.5}{r} = 1$. Multiplying by $2r(r + 8)$, we get $4(2r) + 2.5(2)(r + 8) = 2r(r + 8) \Leftrightarrow 8r + 5r + 40 = 2r^2 + 16r \Leftrightarrow 0 = 2r^2 + 3r - 40 \Rightarrow$

$$r = \frac{-3 \pm \sqrt{(3)^2 - 4(2)(-40)}}{2(2)} = \frac{-3 \pm \sqrt{9 + 320}}{4} = \frac{-3 \pm \sqrt{329}}{4}$$

Since $r \geq 0$, we reject the negative value. She runs at $r = \frac{-3 + \sqrt{329}}{4} \approx 3.78$ mi/h.

76. Substituting 75 for d , we have $75 = x + \frac{x^2}{20} \Leftrightarrow 1500 = 20x + x^2 \Leftrightarrow x^2 + 20x - 1500 = 0 \Leftrightarrow (x - 30)(x + 50) = 0$. So $x = 30$ or $x = -50$. The speed of the car was 30 mi/h.

77. Let x be the length of one side in cm. Then $28 - x$ is the length of the other side. Using the Pythagorean Theorem, we have $x^2 + (28 - x)^2 = 20^2 \Leftrightarrow x^2 + 784 - 56x + x^2 = 400 \Leftrightarrow 2x^2 - 56x + 384 = 0 \Leftrightarrow 2(x^2 - 28x + 192) = 0 \Leftrightarrow 2(x - 12)(x - 16) = 0$. So $x = 12$ or $x = 16$. If $x = 12$, then the other side is $28 - 12 = 16$. Similarly, if $x = 16$, then the other side is 12. The sides are 12 cm and 16 cm.

78. Let l be length of each garden plot. The width of each plot is then $\frac{80}{l}$ and the total amount of fencing material is $4(l) + 6\left(\frac{80}{l}\right) = 88$. Thus $4l + \frac{480}{l} = 88 \Leftrightarrow 4l^2 + 480 = 88l \Leftrightarrow 4l^2 - 88l + 480 = 0 \Leftrightarrow 4(l^2 - 22l + 120) = 0 \Leftrightarrow 4(l - 10)(l - 12) = 0$. So $l = 10$ or $l = 12$. If $l = 10$ ft, then the width of each plot is $\frac{80}{10} = 8$ ft. If $l = 12$ ft, then the width of each plot is $\frac{80}{12} = 6.67$ ft. Both solutions are possible.

79. $3x - 2 > -11 \Leftrightarrow 3x > -9 \Leftrightarrow x > -3$.
Interval: $(-3, \infty)$.

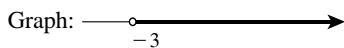

80. $12 - x \geq 7x \Leftrightarrow 12 \geq 8x \Leftrightarrow \frac{3}{2} \geq x$.

Interval: $(-\infty, \frac{3}{2}]$

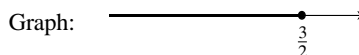

81. $3 - x \leq 2x - 7 \Leftrightarrow 10 \leq 3x \Leftrightarrow \frac{10}{3} \leq x$

Interval: $[\frac{10}{3}, \infty)$

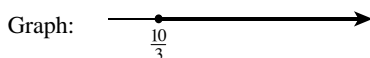

82. $-1 < 2x + 5 \leq 3 \Leftrightarrow -6 < 2x \leq -2 \Leftrightarrow -3 < x \leq -1$

Interval: $(-3, -1]$.

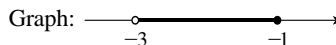

83. $x^2 + 4x - 12 > 0 \Leftrightarrow (x - 2)(x + 6) > 0$. The expression on the left of the inequality changes sign where $x = 2$ and where $x = -6$. Thus we must check the intervals in the following table.

Interval	$(-\infty, -6)$	$(-6, 2)$	$(2, \infty)$
Sign of $x - 2$	-	-	+
Sign of $x + 6$	-	+	+
Sign of $(x - 2)(x + 6)$	+	-	+

Interval: $(-\infty, -6) \cup (2, \infty)$.



84. $x^2 \leq 1 \Leftrightarrow x^2 - 1 \leq 0 \Leftrightarrow (x - 1)(x + 1) \leq 0$. The expression on the left of the inequality changes sign when $x = -1$ and $x = 1$. Thus we must check the intervals in the following table.

Interval	$(-\infty, -1)$	$(-1, 1)$	$(1, \infty)$
Sign of $x - 1$	-	-	+
Sign of $x + 1$	-	+	+
Sign of $(x - 1)(x + 1)$	+	-	+

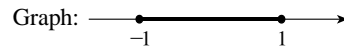
Interval: $[-1, 1]$ 

85. $\frac{2x + 5}{x + 1} \leq 1 \Leftrightarrow \frac{2x + 5}{x + 1} - 1 \leq 0 \Leftrightarrow \frac{2x + 5}{x + 1} - \frac{x + 1}{x + 1} \leq 0 \Leftrightarrow \frac{x + 4}{x + 1} \leq 0$. The expression on the left of the inequality changes sign where $x = -1$ and where $x = -4$. Thus we must check the intervals in the following table.

Interval	$(-\infty, -4)$	$(-4, -1)$	$(-1, \infty)$
Sign of $x + 4$	-	+	+
Sign of $x + 1$	-	-	+
Sign of $\frac{x + 4}{x + 1}$	+	-	+

We exclude $x = -1$, since the expression is not defined at this value. Thus the solution is $[-4, -1)$.

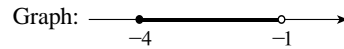

86. $2x^2 \geq x + 3 \Leftrightarrow 2x^2 - x - 3 \geq 0 \Leftrightarrow (2x - 3)(x + 1) \geq 0$. The expression on the left of the inequality changes sign when -1 and $\frac{3}{2}$. Thus we must check the intervals in the following table.

Interval	$(-\infty, -1)$	$(-1, \frac{3}{2})$	$(\frac{3}{2}, \infty)$
Sign of $2x - 3$	-	-	+
Sign of $x + 1$	-	+	+
Sign of $(2x - 3)(x + 1)$	+	-	+

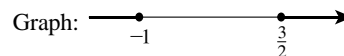
Interval: $(-\infty, -1] \cup [\frac{3}{2}, \infty)$ 

87. $\frac{x - 4}{x^2 - 4} \leq 0 \Leftrightarrow \frac{x - 4}{(x - 2)(x + 2)} \leq 0$. The expression on the left of the inequality changes sign where $x = -2$, where $x = 2$, and where $x = 4$. Thus we must check the intervals in the following table.

Interval	$(-\infty, -2)$	$(-2, 2)$	$(2, 4)$	$(4, \infty)$
Sign of $x - 4$	-	-	-	+
Sign of $x - 2$	-	-	+	+
Sign of $x + 2$	-	+	+	+
Sign of $\frac{x - 4}{(x - 2)(x + 2)}$	-	+	-	+

Since the expression is not defined when $x = \pm 2$, we exclude these values and the solution is $(-\infty, -2) \cup (2, 4]$.



88. $\frac{5}{x^3 - x^2 - 4x + 4} < 0 \Leftrightarrow \frac{5}{x^2(x-1) - 4(x-1)} < 0 \Leftrightarrow \frac{5}{(x-1)(x^2-4)} < 0 \Leftrightarrow \frac{5}{(x-1)(x-2)(x+2)} < 0$. The expression on the left of the inequality changes sign when $-2, 1,$ and 2 . Thus we must check the intervals in the following table.

Interval	$(-\infty, -2)$	$(-2, 1)$	$(1, 2)$	$(2, \infty)$
Sign of $x - 1$	-	-	+	+
Sign of $x - 2$	-	-	-	+
Sign of $x + 2$	-	+	+	+
Sign of $\frac{5}{(x-1)(x-2)(x+2)}$	-	+	-	+

Interval: $(-\infty, -2) \cup (1, 2)$



89. $|x - 5| \leq 3 \Leftrightarrow -3 \leq x - 5 \leq 3 \Leftrightarrow 2 \leq x \leq 8$.
Interval: $[2, 8]$

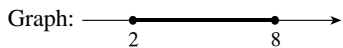

90. $|x - 4| < 0.02 \Leftrightarrow -0.02 < x - 4 < 0.02 \Leftrightarrow 3.98 < x < 4.02$
Interval: $(3.98, 4.02)$

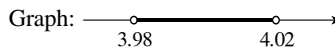

91. $|2x + 1| \geq 1$ is equivalent to $2x + 1 \geq 1$ or $2x + 1 \leq -1$. Case 1: $2x + 1 \geq 1 \Leftrightarrow 2x \geq 0 \Leftrightarrow x \geq 0$. Case 2: $2x + 1 \leq -1 \Leftrightarrow 2x \leq -2 \Leftrightarrow x \leq -1$. Interval: $(-\infty, -1] \cup [0, \infty)$. Graph:

92. $|x - 1|$ is the distance between x and 1 on the number line, and $|x - 3|$ is the distance between x and 3. We want those points that are closer to 1 than to 3. Since 2 is midway between 1 and 3, we get $x \in (-\infty, 2)$ as the solution. Graph:

93. (a) For $\sqrt{24 - x - 3x^2}$ to define a real number, we must have $24 - x - 3x^2 \geq 0 \Leftrightarrow (8 - 3x)(3 + x) \geq 0$. The expression on the left of the inequality changes sign where $8 - 3x = 0 \Leftrightarrow -3x = -8 \Leftrightarrow x = \frac{8}{3}$; or where $x = -3$. Thus we must check the intervals in the following table.

Interval	$(-\infty, -3)$	$(-3, \frac{8}{3})$	$(\frac{8}{3}, \infty)$
Sign of $8 - 3x$	+	+	-
Sign of $3 + x$	-	+	+
Sign of $(8 - 3x)(3 + x)$	-	+	-

Interval: $[-3, \frac{8}{3}]$.

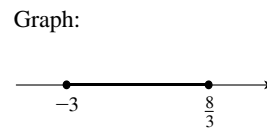

(b) For $\frac{1}{\sqrt[4]{x-x^4}}$ to define a real number we must have $x-x^4 > 0 \Leftrightarrow x(1-x^3) > 0 \Leftrightarrow x(1-x)(1+x+x^2) > 0$.

The expression on the left of the inequality changes sign where $x = 0$; or where $x = 1$; or where $1+x+x^2 = 0 \Rightarrow x = \frac{-1 \pm \sqrt{1^2 - 4(1)(1)}}{2(1)} = \frac{1 \pm \sqrt{1-4}}{2}$ which is imaginary. We check the intervals in the following table.

Interval	$(-\infty, 0)$	$(0, 1)$	$(1, \infty)$
Sign of x	-	+	+
Sign of $1-x$	+	+	-
Sign of $1+x+x^2$	+	+	+
Sign of $x(1-x)(1+x+x^2)$	-	+	-

Interval: $(0, 1)$.

Graph:



94. We have $8 \leq \frac{4}{3}\pi r^3 \leq 12 \Leftrightarrow \frac{6}{\pi} \leq r^3 \leq \frac{9}{\pi} \Leftrightarrow \sqrt[3]{\frac{6}{\pi}} \leq r \leq \sqrt[3]{\frac{9}{\pi}}$. Thus $r \in \left[\sqrt[3]{\frac{6}{\pi}}, \sqrt[3]{\frac{9}{\pi}} \right]$.

95. From the graph, we see that the graphs of $y = x^2 - 4x$ and $y = x + 6$ intersect at $x = -1$ and $x = 6$, so these are the solutions of the equation $x^2 - 4x = x + 6$.

96. From the graph, we see that the graph of $y = x^2 - 4x$ crosses the x -axis at $x = 0$ and $x = 4$, so these are the solutions of the equation $x^2 - 4x = 0$.

97. From the graph, we see that the graph of $y = x^2 - 4x$ lies below the graph of $y = x + 6$ for $-1 < x < 6$, so the inequality $x^2 - 4x \leq x + 6$ is satisfied on the interval $[-1, 6]$.

98. From the graph, we see that the graph of $y = x^2 - 4x$ lies above the graph of $y = x + 6$ for $-\infty < x < -1$ and $6 < x < \infty$, so the inequality $x^2 - 4x \geq x + 6$ is satisfied on the intervals $(-\infty, -1]$ and $[6, \infty)$.

99. From the graph, we see that the graph of $y = x^2 - 4x$ lies above the x -axis for $x < 0$ and for $x > 4$, so the inequality $x^2 - 4x \geq 0$ is satisfied on the intervals $(-\infty, 0]$ and $[4, \infty)$.

100. From the graph, we see that the graph of $y = x^2 - 4x$ lies below the x -axis for $0 < x < 4$, so the inequality $x^2 - 4x \geq 0$ is satisfied on the interval $[0, 4]$.

101. $x^2 - 4x = 2x + 7$. We graph the equations $y_1 = x^2 - 4x$ and $y_2 = 2x + 7$ in the viewing rectangle $[-10, 10]$ by $[-5, 25]$. Using a zoom or trace function, we get the solutions $x = -1$ and $x = 7$.

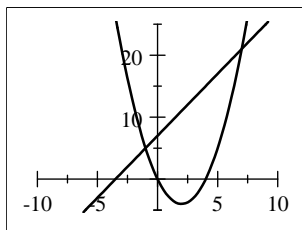

102. $\sqrt{x+4} = x^2 - 5$. We graph the equations $y_1 = \sqrt{x+4}$ and $y_2 = x^2 - 5$ in the viewing rectangle $[-4, 5]$ by $[0, 10]$. Using a zoom or trace function, we get the solutions $x \approx -2.50$ and $x \approx 2.76$.

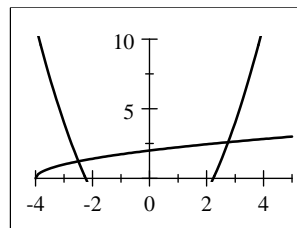

103. $x^4 - 9x^2 = x - 9$. We graph the equations $y_1 = x^4 - 9x^2$ and $y_2 = x - 9$ in the viewing rectangle $[-5, 5]$ by $[-25, 10]$. Using a zoom or trace function, we get the solutions $x \approx -2.72$, $x \approx -1.15$, $x = 1.00$, and $x \approx 2.87$.

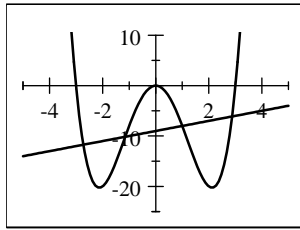

104. $||x + 3| - 5| = 2$. We graph the equations $y_1 = ||x + 3| - 5|$ and $y_2 = 2$ in the viewing rectangle $[-20, 20]$ by $[0, 10]$. Using Zoom and/or Trace, we get the solutions $x = -10$, $x = -6$, $x = 0$, and $x = 4$.

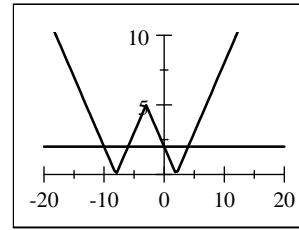

105. $4x - 3 \geq x^2$. We graph the equations $y_1 = 4x - 3$ and $y_2 = x^2$ in the viewing rectangle $[-5, 5]$ by $[0, 15]$. Using a zoom or trace function, we find the points of intersection are at $x = 1$ and $x = 3$. Since we want $4x - 3 \geq x^2$, the solution is the interval $[1, 3]$.

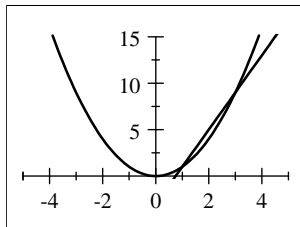

106. $x^3 - 4x^2 - 5x > 2$. We graph the equations $y_1 = x^3 - 4x^2 - 5x$ and $y_2 = 2$ in the viewing rectangle $[-10, 10]$ by $[-5, 5]$. We find that the point of intersection is at $x \approx 5.07$. Since we want $x^3 - 4x^2 - 5x > 2$, the solution is the interval $(5.07, \infty)$.

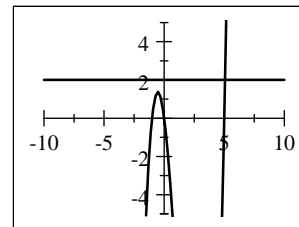

107. $x^4 - 4x^2 < \frac{1}{2}x - 1$. We graph the equations $y_1 = x^4 - 4x^2$ and $y_2 = \frac{1}{2}x - 1$ in the viewing rectangle $[-5, 5]$ by $[-5, 5]$. We find the points of intersection are at $x \approx -1.85$, $x \approx -0.60$, $x \approx 0.45$, and $x = 2.00$. Since we want $x^4 - 4x^2 < \frac{1}{2}x - 1$, the solution is $(-1.85, -0.60) \cup (0.45, 2.00)$.

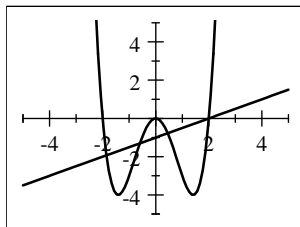

108. $|x^2 - 16| - 10 \geq 0$. We graph the equation $y = |x^2 - 16| - 10$ in the viewing rectangle $[-10, 10]$ by $[-10, 10]$. Using a zoom or trace function, we find that the x -intercepts are $x \approx \pm 5.10$ and $x \approx \pm 2.45$. Since we want $|x^2 - 16| - 10 \geq 0$, the solution is approximately $(-\infty, -5.10] \cup [-2.45, 2.45] \cup [5.10, \infty)$.

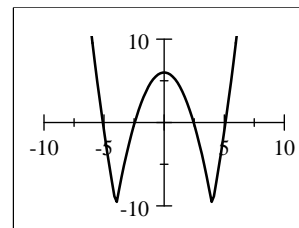

109. Here the center is at $(0, 0)$, and the circle passes through the point $(-5, 12)$, so the radius is

$$r = \sqrt{(-5 - 0)^2 + (12 - 0)^2} = \sqrt{25 + 144} = \sqrt{169} = 13. \text{ The equation of the circle is } x^2 + y^2 = 13^2 \Leftrightarrow$$

$x^2 + y^2 = 169$. The line shown is the tangent that passes through the point $(-5, 12)$, so it is perpendicular to the line

through the points $(0, 0)$ and $(-5, 12)$. This line has slope $m_1 = \frac{12 - 0}{-5 - 0} = -\frac{12}{5}$. The slope of the line we seek is

$$m_2 = -\frac{1}{m_1} = -\frac{1}{-12/5} = \frac{5}{12}. \text{ Thus, an equation of the tangent line is } y - 12 = \frac{5}{12}(x + 5) \Leftrightarrow y - 12 = \frac{5}{12}x + \frac{25}{12} \Leftrightarrow$$

$$y = \frac{5}{12}x + \frac{169}{12} \Leftrightarrow 5x - 12y + 169 = 0.$$

110. Because the circle is tangent to the x -axis at the point $(5, 0)$ and tangent to the y -axis at the point $(0, 5)$, the center is at $(5, 5)$ and the radius is 5. Thus an equation is $(x - 5)^2 + (y - 5)^2 = 5^2 \Leftrightarrow (x - 5)^2 + (y - 5)^2 = 25$. The slope of

the line passing through the points $(8, 1)$ and $(5, 5)$ is $m = \frac{5 - 1}{5 - 8} = \frac{4}{-3} = -\frac{4}{3}$, so an equation of the line we seek is

$$y - 1 = -\frac{4}{3}(x - 8) \Leftrightarrow 4x + 3y - 35 = 0.$$

111. Since M varies directly as z we have $M = kz$. Substituting $M = 120$ when $z = 15$, we find $120 = k(15) \Leftrightarrow k = 8$. Therefore, $M = 8z$.

112. Since z is inversely proportional to y , we have $z = \frac{k}{y}$. Substituting $z = 12$ when $y = 16$, we find $12 = \frac{k}{16} \Leftrightarrow k = 192$.

$$\text{Therefore } z = \frac{192}{y}.$$

113. (a) The intensity I varies inversely as the square of the distance d , so $I = \frac{k}{d^2}$.

(b) Substituting $I = 1000$ when $d = 8$, we get $1000 = \frac{k}{(8)^2} \Leftrightarrow k = 64,000$.

(c) From parts (a) and (b), we have $I = \frac{64,000}{d^2}$. Substituting $d = 20$, we get $I = \frac{64,000}{(20)^2} = 160$ candles.

114. Let f be the frequency of the string and l be the length of the string. Since the frequency is inversely proportional to the length, we have $f = \frac{k}{l}$. Substituting $l = 12$ when $k = 440$, we find $440 = \frac{k}{12} \Leftrightarrow k = 5280$. Therefore $f = \frac{5280}{l}$. For

$f = 660$, we must have $660 = \frac{5280}{l} \Leftrightarrow l = \frac{5280}{660} = 8$. So the string needs to be shortened to 8 inches.

115. Let v be the terminal velocity of the parachutist in mi/h and w be his weight in pounds. Since the terminal velocity is directly proportional to the square root of the weight, we have $v = k\sqrt{w}$. Substituting $v = 9$ when $w = 160$, we solve

for k . This gives $9 = k\sqrt{160} \Leftrightarrow k = \frac{9}{\sqrt{160}} \approx 0.712$. Thus $v = 0.712\sqrt{w}$. When $w = 240$, the terminal velocity is

$$v = 0.712\sqrt{240} \approx 11 \text{ mi/h.}$$

116. Let r be the maximum range of the baseball and v be the velocity of the baseball. Since the maximum range is directly proportional to the square of the velocity, we have $r = lv^2$. Substituting $v = 60$ and $r = 242$, we find $242 = k(60)^2 \Leftrightarrow k \approx 0.0672$. If $v = 70$, then we have a maximum range of $r = 0.0672(70)^2 = 329.4$ feet.

CHAPTER 1 TEST

1. (a)

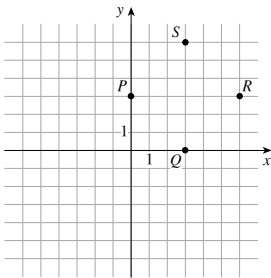

There are several ways to determine the coordinates of S . The diagonals of a square have equal length and are perpendicular. The diagonal PR is horizontal and has length 6 units, so the diagonal QS is vertical and also has length 6. Thus, the coordinates of S are $(3, 6)$.

(b) The length of PQ is $\sqrt{(0-3)^2 + (3-0)^2} = \sqrt{18} = 3\sqrt{2}$. So the area of $PQRS$ is $(3\sqrt{2})^2 = 18$.

2. (a)

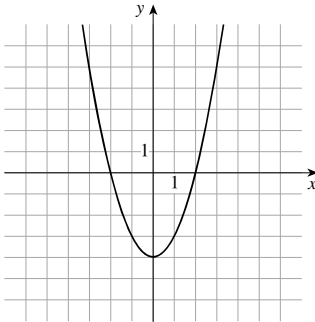

(b) The x -intercept occurs when $y = 0$, so $0 = x^2 - 4 \Leftrightarrow x^2 = 4 \Rightarrow x = \pm 2$. The y -intercept occurs when $x = 0$, so $y = -4$.

(c) x -axis symmetry: $(-y) = x^2 - 4 \Leftrightarrow y = -x^2 + 4$, which is not the same as the original equation, so the graph is not symmetric with respect to the x -axis.

y -axis symmetry: $y = (-x)^2 - 4 \Leftrightarrow y = x^2 - 4$, which is the same as the original equation, so the graph is symmetric with respect to the y -axis.

Origin symmetry: $(-y) = (-x)^2 - 4 \Leftrightarrow -y = x^2 - 4$, which is not the same as the original equation, so the graph is not symmetric with respect to the origin.

3. (a)

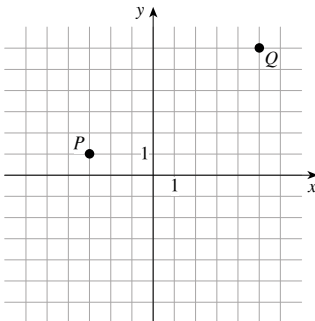

(b) The distance between P and Q is

$$d(P, Q) = \sqrt{(-3-5)^2 + (1-6)^2} = \sqrt{64+25} = \sqrt{89}.$$

(c) The midpoint is $\left(\frac{-3+5}{2}, \frac{1+6}{2}\right) = \left(1, \frac{7}{2}\right)$.

(d) The slope of the line is $\frac{1-6}{-3-5} = \frac{-5}{-8} = \frac{5}{8}$.

(e) The perpendicular bisector of PQ contains the midpoint, $\left(1, \frac{7}{2}\right)$, and its slope is the negative reciprocal of $\frac{5}{8}$. Thus the slope is $-\frac{1}{5/8} = -\frac{8}{5}$. Hence the equation

$$\text{is } y - \frac{7}{2} = -\frac{8}{5}(x - 1) \Leftrightarrow y = -\frac{8}{5}x + \frac{8}{5} + \frac{7}{2} = -\frac{8}{5}x + \frac{51}{10}.$$

$$y = -\frac{8}{5}x + \frac{51}{10}.$$

(f) The center of the circle is the midpoint, $\left(1, \frac{7}{2}\right)$, and the length of the radius is $\frac{1}{2}\sqrt{89}$. Thus the equation of the circle whose diameter is PQ is $(x-1)^2 + \left(y - \frac{7}{2}\right)^2 = \left(\frac{1}{2}\sqrt{89}\right)^2 \Leftrightarrow (x-1)^2 + \left(y - \frac{7}{2}\right)^2 = \frac{89}{4}$.

4. (a) $x^2 + y^2 = 25 = 5^2$ has center $(0, 0)$ and radius 5. (b) $(x - 2)^2 + (y + 1)^2 = 9 = 3^2$ has center $(2, -1)$ and radius 3. (c) $x^2 + 6x + y^2 - 2y + 6 = 0 \Leftrightarrow x^2 + 6x + 9 + y^2 - 2y + 1 = 4 \Leftrightarrow (x + 3)^2 + (y - 1)^2 = 4 = 2^2$ has center $(-3, 1)$ and radius 2.

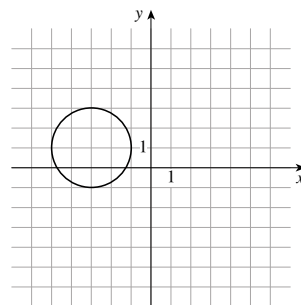
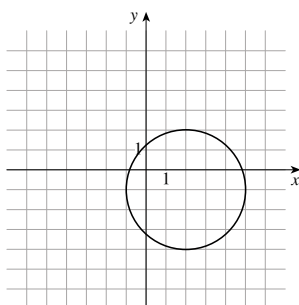
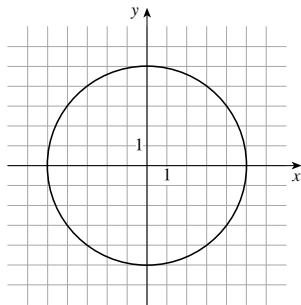

5. (a) $x = 4 - y^2$. To test for symmetry about the x -axis, we replace y with $-y$: $x = 4 - (-y)^2 \Leftrightarrow x = 4 - y^2$, so the graph is symmetric about the x -axis.

To test for symmetry about the y -axis, we replace x with $-x$:

$-x = 4 - y^2$ is different from the original equation, so the graph is not symmetric about the y -axis.

For symmetry about the origin, we replace x with $-x$ and y with $-y$:

$-x = 4 - (-y)^2 \Leftrightarrow -x = 4 - y^2$, which is different from the original equation, so the graph is not symmetric about the origin.

To find x -intercepts, we set $y = 0$ and solve for x : $x = 4 - 0^2 = 4$, so the x -intercept is 4.

To find y -intercepts, we set $x = 0$ and solve for y : $0 = 4 - y^2 \Leftrightarrow y^2 = 4 \Leftrightarrow y = \pm 2$, so the y -intercepts are -2 and 2 .

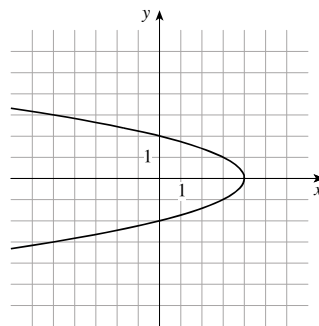

- (b) $y = |x - 2|$. To test for symmetry about the x -axis, we replace y with $-y$: $-y = |x - 2|$ is different from the original equation, so the graph is not symmetric about the x -axis.

To test for symmetry about the y -axis, we replace x with $-x$:

$y = |-x - 2| = |x + 2|$ is different from the original equation, so the graph is not symmetric about the y -axis.

To test for symmetry about the origin, we replace x with $-x$ and y with $-y$:

$-y = |-x - 2| \Leftrightarrow y = -|x + 2|$, which is different from the original equation, so the graph is not symmetric about the origin.

To find x -intercepts, we set $y = 0$ and solve for x : $0 = |x - 2| \Leftrightarrow$

$x - 2 = 0 \Leftrightarrow x = 2$, so the x -intercept is 2.

To find y -intercepts, we set $x = 0$ and solve for y :

$y = |0 - 2| = |-2| = 2$, so the y -intercept is 2.

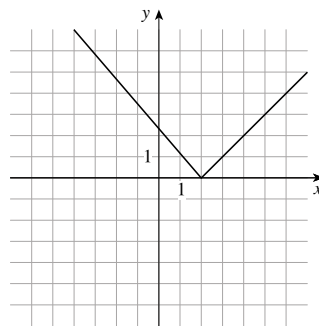

6. (a) To find the x -intercept, we set $y = 0$ and solve for x : $3x - 5(0) = 15$ (b)

$$\Leftrightarrow 3x = 15 \Leftrightarrow x = 5, \text{ so the } x\text{-intercept is } 5.$$

To find the y -intercept, we set $x = 0$ and solve for y : $3(0) - 5y = 15$

$$\Leftrightarrow -5y = 15 \Leftrightarrow y = -3, \text{ so the } y\text{-intercept is } -3.$$

(c) $3x - 5y = 15 \Leftrightarrow 5y = 3x - 15 \Leftrightarrow y = \frac{3}{5}x - 3.$

(d) From part (c), the slope is $\frac{3}{5}.$

(e) The slope of any line perpendicular to the given line is the negative reciprocal of its slope, that is, $-\frac{1}{3/5} = -\frac{5}{3}.$

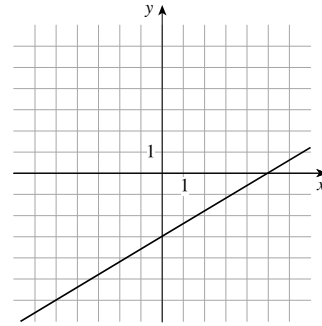

7. (a) $3x + y - 10 = 0 \Leftrightarrow y = -3x + 10$, so the slope of the line we seek is -3 . Using the point-slope, $y - (-6) = -3(x - 3)$
 $\Leftrightarrow y + 6 = -3x + 9 \Leftrightarrow 3x + y - 3 = 0.$

(b) Using the intercept form we get $\frac{x}{6} + \frac{y}{4} = 1 \Leftrightarrow 2x + 3y = 12 \Leftrightarrow 2x + 3y - 12 = 0.$

8. (a) When $x = 100$ we have $T = 0.08(100) - 4 = 8 - 4 = 4$, so the temperature at one meter is $4^\circ \text{C}.$ (b)

(c) The slope represents an increase of 0.08°C for each one-centimeter increase in depth, the x -intercept is the depth at which the temperature is 0°C , and the T -intercept is the temperature at ground level.

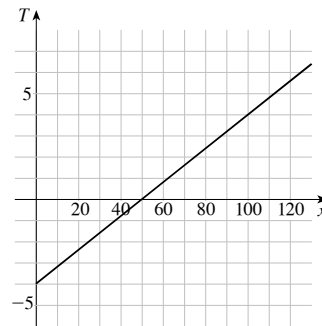

9. (a) $x^2 - x - 12 = 0 \Leftrightarrow (x - 4)(x + 3) = 0.$ So $x = 4$ or $x = -3.$

(b) $2x^2 + 4x + 1 = 0 \Rightarrow x = \frac{-4 \pm \sqrt{4^2 - 4(2)(1)}}{2(2)} = \frac{-4 \pm \sqrt{16 - 8}}{4} = \frac{-4 \pm \sqrt{8}}{4} = \frac{-4 \pm 2\sqrt{2}}{4} = \frac{-2 \pm \sqrt{2}}{2}.$

(c) $3 - \sqrt{x-3} = x \Leftrightarrow 3 - x = \sqrt{x-3} \Leftrightarrow (3-x)^2 = (\sqrt{x-3})^2 \Leftrightarrow x^2 - 6x + 9 = 3 - x \Leftrightarrow x^2 - 5x + 6 = (x-2)(x-3) = 0.$ Thus, $x = 2$ and $x = 3$ are potential solutions. Checking in the original equation, we see that only $x = 3$ is valid.

(d) $x^{1/2} - 3x^{1/4} + 2 = 0.$ Let $u = x^{1/4}$, then we have $u^2 - 3u + 2 = 0 \Leftrightarrow (u-2)(u-1) = 0.$ So either $u - 2 = 0$ or $u - 1 = 0.$ If $u - 2 = 0$, then $u = 2 \Leftrightarrow x^{1/4} = 2 \Leftrightarrow x = 2^4 = 16.$ If $u - 1 = 0$, then $u = 1 \Leftrightarrow x^{1/4} = 1 \Leftrightarrow x = 1.$ So $x = 1$ or $x = 16.$

(e) $x^4 - 3x^2 + 2 = 0 \Leftrightarrow (x^2 - 1)(x^2 - 2) = 0.$ So $x^2 - 1 = 0 \Leftrightarrow x = \pm 1$ or $x^2 - 2 = 0 \Leftrightarrow x = \pm\sqrt{2}.$ Thus the solutions are $x = -1, x = 1, x = -\sqrt{2},$ and $x = \sqrt{2}.$

(f) $3|x-4| - 10 = 0 \Leftrightarrow 3|x-4| = 10 \Leftrightarrow |x-4| = \frac{10}{3} \Leftrightarrow x - 4 = \pm\frac{10}{3} \Leftrightarrow x = 4 \pm \frac{10}{3}.$ So $x = 4 - \frac{10}{3} = \frac{2}{3}$ or $x = 4 + \frac{10}{3} = \frac{22}{3}.$ Thus the solutions are $x = \frac{2}{3}$ and $x = \frac{22}{3}.$

10. (a) $(3 - 2i) + (4 + 3i) = 3 + 4 + (-2i + 3i) = 7 + i$

(b) $(3 - 2i) - (4 + 3i) = (3 - 4) + (-2i - 3i) = -1 - 5i$

(c) $(3 - 2i)(4 + 3i) = 3 \cdot 4 + 3 \cdot 3i - 2i \cdot 4 - 2i \cdot 3i = 12 + 9i - 8i - 6i^2 = 12 + i - 6(-1) = 18 + i$

(d) $\frac{3-2i}{4+3i} = \frac{3-2i}{4+3i} \cdot \frac{4-3i}{4-3i} = \frac{12-17i+6i^2}{16-9i^2} = \frac{12-17i-6}{16+9} = \frac{6}{25} - \frac{17}{25}i$

(e) $i^{48} = (i^2)^{24} = (-1)^{24} = 1$

$$(f) (\sqrt{2} - \sqrt{-2})(\sqrt{8} + \sqrt{-2}) = \sqrt{2} \cdot 8 + \sqrt{2}(-2) - \sqrt{(-2)8} - (\sqrt{-2})^2 = 4 + 2i - 4i - (-2) = 6 - 2i$$

$$11. \text{ Using the Quadratic Formula, } 2x^2 + 4x + 3 = 0 \Leftrightarrow x = \frac{-4 \pm \sqrt{4^2 - 4(2)(3)}}{2(2)} = \frac{-4 \pm \sqrt{-8}}{4} = -1 \pm \frac{\sqrt{2}}{2}i.$$

12. Let w be the width of the parcel of land. Then $w + 70$ is the length of the parcel of land. Then $w^2 + (w + 70)^2 = 130^2 \Leftrightarrow w^2 + w^2 + 140w + 4900 = 16,900 \Leftrightarrow 2w^2 + 140w - 12,000 = 0 \Leftrightarrow w^2 + 70w - 6000 = 0 \Leftrightarrow (w - 50)(w + 120) = 0$. So $w = 50$ or $w = -120$. Since $w \geq 0$, the width is $w = 50$ ft and the length is $w + 70 = 120$ ft.

13. (a) $-4 < 5 - 3x \leq 17 \Leftrightarrow -9 < -3x \leq 12 \Leftrightarrow 3 > x \geq -4$. Expressing in standard form we have: $-4 \leq x < 3$.

Interval: $[-4, 3)$. Graph: 

(b) $x(x - 1)(x + 2) > 0$. The expression on the left of the inequality changes sign when $x = 0$, $x = 1$, and $x = -2$. Thus we must check the intervals in the following table.

Interval	$(-\infty, -2)$	$(-2, 0)$	$(0, 1)$	$(1, \infty)$
Sign of x	-	-	+	+
Sign of $x - 1$	-	-	-	+
Sign of $x + 2$	-	+	+	+
Sign of $x(x - 1)(x + 2)$	-	+	-	+

From the table, the solution set is $\{x \mid -2 < x < 0 \text{ or } 1 < x\}$. Interval: $(-2, 0) \cup (1, \infty)$.

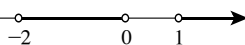
Graph: 

(c) $|x - 4| < 3$ is equivalent to $-3 < x - 4 < 3 \Leftrightarrow 1 < x < 7$. Interval: $(1, 7)$. Graph: 

(d) $\frac{2x - 3}{x + 1} \leq 1 \Leftrightarrow \frac{2x - 3}{x + 1} - 1 \leq 0 \Leftrightarrow \frac{2x - 3}{x + 1} - \frac{x + 1}{x + 1} \leq 0 \Leftrightarrow \frac{x - 4}{x + 1} \leq 0$. The expression on the left of the inequality changes sign where $x = -4$ and where $x = -1$. Thus we must check the intervals in the following table.

Interval	$(-\infty, -1)$	$(-1, 4)$	$(4, \infty)$
Sign of $x - 4$	-	-	+
Sign of $x + 1$	-	+	+
Sign of $\frac{x - 4}{x + 1}$	+	-	+

Since $x = -1$ makes the expression in the inequality undefined, we exclude this value. Interval: $(-1, 4]$.

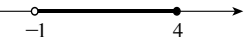
Graph: 

14. $5 \leq \frac{5}{9}(F - 32) \leq 10 \Leftrightarrow 9 \leq F - 32 \leq 18 \Leftrightarrow 41 \leq F \leq 50$. Thus the medicine is to be stored at a temperature between 41° F and 50° F.

15. For $\sqrt{6x - x^2}$ to be defined as a real number $6x - x^2 \geq 0 \Leftrightarrow x(6 - x) \geq 0$. The expression on the left of the inequality changes sign when $x = 0$ and $x = 6$. Thus we must check the intervals in the following table.

Interval	$(-\infty, 0)$	$(0, 6)$	$(6, \infty)$
Sign of x	-	+	+
Sign of $6 - x$	+	+	-
Sign of $x(6 - x)$	-	+	-

From the table, we see that $\sqrt{6x - x^2}$ is defined when $0 \leq x \leq 6$.

16. (a) $x^3 - 9x - 1 = 0$. We graph the equation $y = x^3 - 9x - 1$ in the viewing rectangle $[-5, 5]$ by $[-10, 10]$. We find that the points of intersection occur at $x \approx -2.94, -0.11, 3.05$.

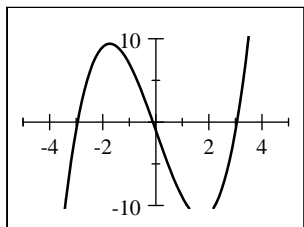

(b) $x^2 - 1 \leq |x + 1|$. We graph the equations $y_1 = x^2 - 1$ and $y_2 = |x + 1|$ in the viewing rectangle $[-5, 5]$ by $[-5, 10]$. We find that the points of intersection occur at $x = -1$ and $x = 2$. Since we want $x^2 - 1 \leq |x + 1|$, the solution is the interval $[-1, 2]$.

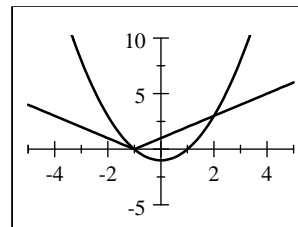

17. (a) $M = k \frac{wh^2}{L}$

(b) Substituting $w = 4, h = 6, L = 12$, and $M = 4800$, we have $4800 = k \frac{(4)(6^2)}{12} \Leftrightarrow k = 400$. Thus $M = 400 \frac{wh^2}{L}$.

(c) Now if $L = 10, w = 3$, and $h = 10$, then $M = 400 \frac{(3)(10^2)}{10} = 12,000$. So the beam can support 12,000 pounds.

FOCUS ON MODELING Fitting Lines to Data

1. (a)

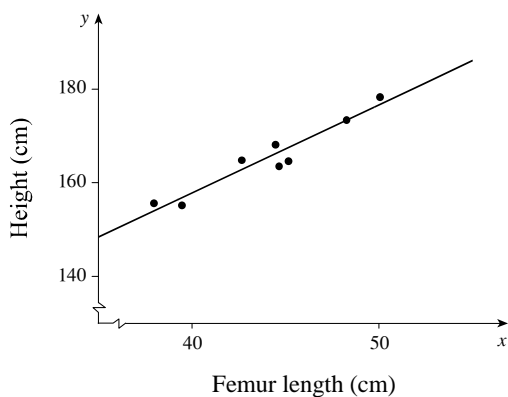

(b) Using a graphing calculator, we obtain the regression line $y = 1.8807x + 82.65$.

(c) Using $x = 58$ in the equation $y = 1.8807x + 82.65$, we get $y = 1.8807(58) + 82.65 \approx 191.7$ cm.

2. (a)

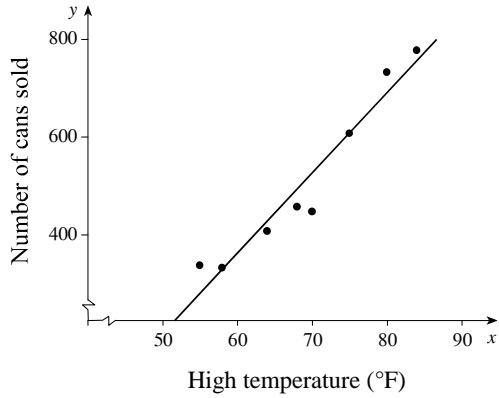

(b) Using a graphing calculator, we obtain the regression line $y = 16.4163x - 621.83$.

(c) Using $x = 95$ in the equation $y = 16.4163x - 621.83$, we get $y = 16.4163(95) - 621.83 \approx 938$ cans.

3. (a)

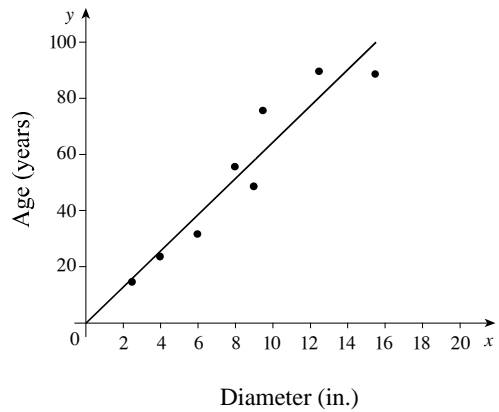

(b) Using a graphing calculator, we obtain the regression line $y = 6.451x - 0.1523$.

(c) Using $x = 18$ in the equation $y = 6.451x - 0.1523$, we get $y = 6.451(18) - 0.1523 \approx 116$ years.

4. (a)

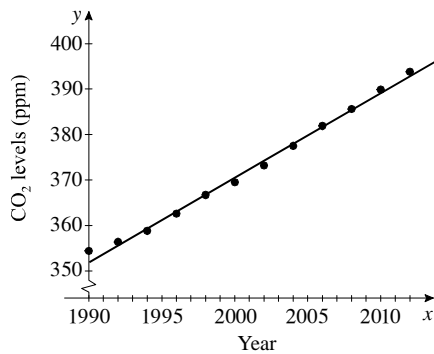

(b) Letting $x = 0$ correspond to 1990, we obtain the regression line $y = 1.8446x + 352.2$.

(c) Using $x = 21$ in the equation $y = 1.8446x + 352.2$, we get $y = 1.8446(21) + 352.2 \approx 390.9$ ppm CO₂, slightly lower than the measured value.

5. (a)

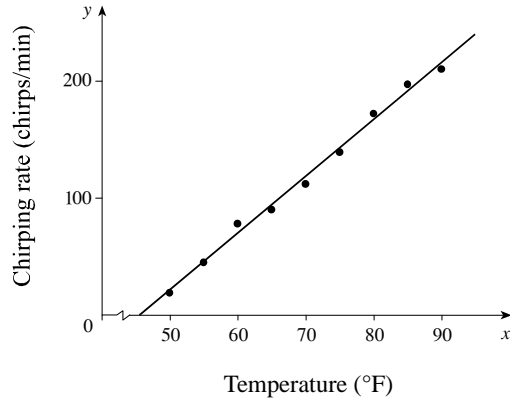

(b) Using a graphing calculator, we obtain the regression line $y = 4.857x - 220.97$.

(c) Using $x = 100^\circ$ F in the equation $y = 4.857x - 220.97$, we get $y \approx 265$ chirps per minute.

6. (a)

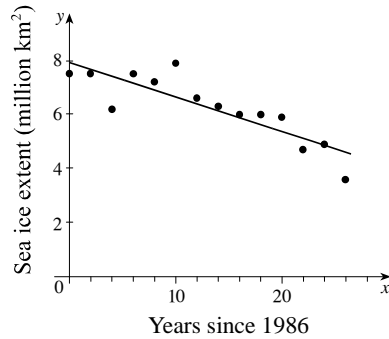

(b) Using a graphing calculator, we obtain the regression line $y = -0.1275x + 7.929$.

(c) Using $x = 30$ in the regression line equation, we get $y = -0.1275(30) + 7.929 \approx 4.10$ million km^2 .

7. (a)

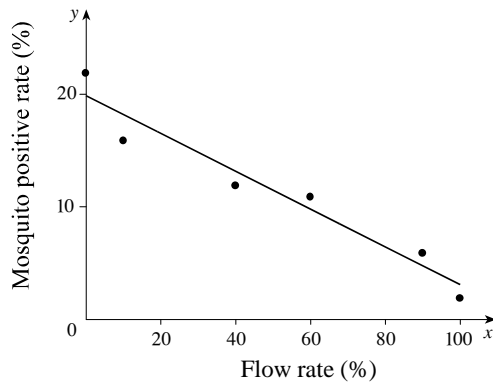

(b) Using a graphing calculator, we obtain the regression line $y = -0.168x + 19.89$.

(c) Using the regression line equation $y = -0.168x + 19.89$, we get $y \approx 8.13\%$ when $x = 70\%$.

8. (a)

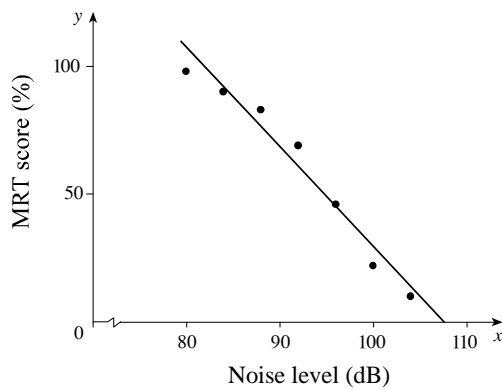

(b) Using a graphing calculator, we obtain $y = -3.9018x + 419.7$.

(c) The correlation coefficient is $r = -0.98$, so linear model is appropriate for x between 80 dB and 104 dB.

(d) Substituting $x = 94$ into the regression equation, we get $y = -3.9018(94) + 419.7 \approx 53$. So the intelligibility is about 53%.

9. (a)

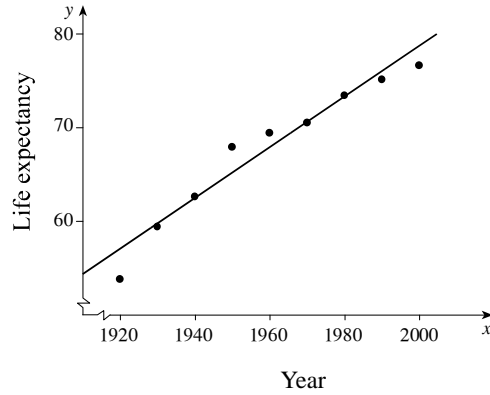

(b) Using a graphing calculator, we obtain

$$y = 0.27083x - 462.9.$$

(c) We substitute $x = 2006$ in the model

$y = 0.27083x - 462.9$ to get $y = 80.4$, that is, a life expectancy of 80.4 years.

(d) The life expectancy of a child born in the US in 2006 was 77.7 years, considerably less than our estimate in part (b).

10. (a)

Year	x	Height (m)
1972	0	5.64
1976	4	5.64
1980	8	5.78
1984	12	5.75
1988	16	5.90
1992	20	5.87
1996	24	5.92
2000	28	5.90
2004	32	5.95
2008	36	5.96

(b) Using a graphing calculator, we obtain the regression

$$\text{line } y = 5.664 + 0.00929x.$$

11. Students should find a fairly strong correlation between shoe size and height.

12. Results will depend on student surveys in each class.

(c)

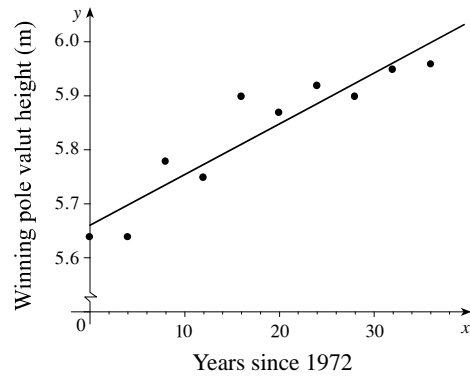

The regression line provides a good model.

(d) The regression line predicts the winning pole vault height in 2012 to be

$$y = 0.00929(2012 - 1972) + 5.664 \approx 6.04 \text{ meters.}$$